

CMZ
TC 35
M/MMS/Y/YS



High-tech from heimatec - heimatec - Tools and systems for productive turning and milling

heimatec belongs to the international technology and quality leaders for precision tools and specializes in the development and production of high-precision static and live tools for all CNC lathes, CNC turn-/mill machines and CNC machining centers.

The range of products* spans from static BMT and VDI tool holders, live tools up to highly complex customer-specific individual solutions. heimatec, headquartered in Renchen, has a own subsidiary in Asia and India and numerous representatives as well as trading partners all over the world.

*OUR PRODCUTS

Static tool holders

Live tool units

Precision tools

Tools for turning and machining centres

Tools for swiss type lathes

Tool changing and uick-change systems

Tool systems for gear production

Digital tool management

This catalogue, including all its parts, is protected by copyright. Any use outside the restricted limitations of the Copyright Act without the consent of heimatec is inadmissible and liable to prosecution. This applies in particular to duplication, translation, microfilming and storage and processing in electronic systems.

heimatec GmbH reserves the right to make technical changes at any time without giving prior notice. This applies in particular to adjustments at any time to meet new or changed international standards, or in case of further developments of our products or manufacturing processes.

The current version of our General Terms and Conditions can be found on our website.

Part-#	Name	
8 010 34 012	Axial drilling and milling head ER 20 IC	
	Weight [kg]:	5.640
	Tool drive:	Flat (~DIN 1809)
	Shank size [mm]:	32.00
	Shank type:	BMT
	Tool adaption:	ER 20
	Gear ratio [i]:	1:1
	Torque max [Nm]:	50
	Rotation max [1/min]:	6000
	Rotating direction:	same
	Coolant:	IC/Ext
	Pressure max [bar]:	25
8 010 35 014	Axial drilling and milling head ER 25 AX UT	
	Weight [kg]:	5.290
	Tool drive:	Flat (~DIN 1809)
	Shank size [mm]:	32.00
	Shank type:	BMT
	Tool adaption:	ER 25 A - u-tec
	Gear ratio [i]:	1:1
	Torque max [Nm]:	50
	Rotation max [1/min]:	12000
	Rotating direction:	same
	Coolant:	EXT
	Please note:	stronger bearing
8 010 36 000	Axial drilling and milling head ER 32 IC	
	Weight [kg]:	5.560
	Tool drive:	Flat (~DIN 1809)
	Shank size [mm]:	32.00
	Shank type:	BMT
	Tool adaption:	ER 32
	Gear ratio [i]:	1:1
	Torque max [Nm]:	50
	Rotation max [1/min]:	6000
	Rotating direction:	same
	Coolant:	IC/Ext
	Pressure max [bar]:	25
8 010 36 001	Axial drilling and milling head ER 32	
	Weight [kg]:	5.520
	Tool drive:	Flat (~DIN 1809)
	Shank size [mm]:	32.00
	Shank type:	BMT
	Tool adaption:	ER 32
	Gear ratio [i]:	1:1
	Torque max [Nm]:	50
	Rotation max [1/min]:	8000
	Rotating direction:	same
	Coolant:	EXT

Part-#

Name

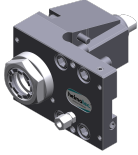
8 010 36 007**Axial drilling and milling head ER 32 AX UT**

Weight [kg]:	5.470
Tool drive:	Flat (~DIN 1809)
Shank size [mm]:	32.00
Shank type:	BMT
Tool adaption:	ER 32 A - u-tec
Gear ratio [i]:	1:1
Torque max [Nm]:	50
Rotation max [1/min]:	8000
Rotating direction:	same
Coolant:	EXT
Please note:	stronger bearing

8 010 36 008**Axial drilling and milling head ER 32 IC**

Tool drive:	Flat (~DIN 1809)
Shank size [mm]:	32.00
Shank type:	BMT
Tool adaption:	ER 32
Gear ratio [i]:	1:1
Torque max [Nm]:	50
Rotation max [1/min]:	6000
Rotating direction:	same
Coolant:	IC/Ext
Pressure max [bar]:	25
Please note:	Combi bearing

8 010 36 009**Axial drilling and milling head ER 32 AX UT IC**

Weight [kg]:	5.550
Tool drive:	Flat (~DIN 1809)
Shank size [mm]:	32.00
Shank type:	BMT
Tool adaption:	ER 32 A - u-tec
Gear ratio [i]:	1:1
Torque max [Nm]:	50
Rotation max [1/min]:	6000
Rotating direction:	same
Coolant:	IC/Ext
Pressure max [bar]:	25
Please note:	stronger bearing

8 010 36 016**Axial drilling and milling head ER 32 AX UT IC**

Weight [kg]:	5.500
Tool drive:	Flat (~DIN 1809)
Shank size [mm]:	32.00
Shank type:	BMT
Tool adaption:	ER 32 A - u-tec
Gear ratio [i]:	1:1
Torque max [Nm]:	50
Rotation max [1/min]:	12000
Rotating direction:	same
Coolant:	IC/Ext
Pressure max [bar]:	25
Please note:	stronger bearing

Part-#	Name	
8 010 37 000	Axial drilling and milling head HT 5	
	Weight [kg]:	5.510
	Tool drive:	Flat (~DIN 1809)
	Shank size [mm]:	32.00
	Shank type:	BMT
	Tool adaption:	HT 5
	Gear ratio [i]:	1:1
	Torque max [Nm]:	50
	Rotation max [1/min]:	8000
	Rotating direction:	same
	Coolant:	EXT
8 010 37 001	Axial drilling and milling head HT 5 IC	
	Weight [kg]:	5.530
	Tool drive:	Flat (~DIN 1809)
	Shank size [mm]:	32.00
	Shank type:	BMT
	Tool adaption:	HT 5
	Gear ratio [i]:	1:1
	Torque max [Nm]:	50
	Rotation max [1/min]:	6000
	Rotating direction:	same
	Coolant:	IC/Ext
	Pressure max [bar]:	25
8 010 37 002	Axial drilling and milling head ER 40 IC	
	Weight [kg]:	5.800
	Tool drive:	Flat (~DIN 1809)
	Shank size [mm]:	32.00
	Shank type:	BMT
	Tool adaption:	ER 40
	Gear ratio [i]:	1:1
	Torque max [Nm]:	50
	Rotation max [1/min]:	6000
	Rotating direction:	same
	Coolant:	IC/Ext
	Pressure max [bar]:	25
8 011 34 004	Axial milling head universal arbor 16	
	Weight [kg]:	5.470
	Tool drive:	Flat (~DIN 1809)
	Shank size [mm]:	32.00
	Shank type:	BMT
	Tool adaption:	Universal arbor 16
	Gear ratio [i]:	1:1
	Torque max [Nm]:	50
	Rotation max [1/min]:	6000
	Rotating direction:	same
	Coolant:	EXT
8 011 35 000	Axial milling head universal arbor 22	
	Weight [kg]:	5.580
	Tool drive:	Flat (~DIN 1809)
	Shank size [mm]:	32.00
	Shank type:	BMT
	Tool adaption:	Universal arbor 22
	Gear ratio [i]:	1:1
	Torque max [Nm]:	50

Part-#	Name	
	Rotation max [1/min]:	6000
	Rotating direction:	same
	Coolant:	EXT
8 030 34 005	Radial drilling and milling head ER 20	
	Weight [kg]:	10.680
	Tool drive:	Flat (~DIN 1809)
	Shank size [mm]:	32.00
	Shank type:	BMT
	Tool adaption:	ER 20
	Gear ratio [i]:	1:3
	Torque max [Nm]:	8
	Rotation max [1/min]:	12000
	Rotating direction:	opposite
	Coolant:	EXT
	Center distance [mm]:	55
8 030 34 012	Radial drilling and milling head ER 20 IC	
	Employment for:	Main spindle
	Tool drive:	Flat (~DIN 1809)
	Shank size [mm]:	32.00
	Shank type:	BMT
	Tool adaption:	ER 20
	Gear ratio [i]:	1:1
	Torque max [Nm]:	50
	Rotation max [1/min]:	6000
	Rotating direction:	opposite
	Coolant:	IC/Ext
	Pressure max [bar]:	25
	Center distance [mm]:	55
8 030 34 013	Radial drilling and milling head ER 20 IC	
	Employment for:	Sub spindle
	Tool drive:	Flat (~DIN 1809)
	Shank size [mm]:	32.00
	Shank type:	BMT
	Tool adaption:	ER 20
	Gear ratio [i]:	1:1
	Torque max [Nm]:	50
	Rotation max [1/min]:	6000
	Rotating direction:	same
	Coolant:	IC/Ext
	Pressure max [bar]:	25
	Please note:	note center distance 55 !
	Center distance [mm]:	55
8 030 35 014	Radial drilling and milling head ER 25 AX UT IC	
	Weight [kg]:	10.320
	Employment for:	Sub spindle
	Tool drive:	Flat (~DIN 1809)
	Shank size [mm]:	32.00
	Shank type:	BMT
	Tool adaption:	ER 25 A - u-tec
	Gear ratio [i]:	1:2
	Torque max [Nm]:	16
	Rotation max [1/min]:	12000
	Rotating direction:	opposite
	Coolant:	IC/Ext

Part-#	Name	
	Pressure max [bar]:	140
	Please note:	note center distance 55 !
	Center distance [mm]:	55
8 030 35 027	Radial drilling and milling head ER 25 AX UT IC	
	Weight [kg]:	10.350
	Employment for:	Main spindle
	Tool drive:	Flat (~DIN 1809)
	Shank size [mm]:	32.00
	Shank type:	BMT
	Tool adaption:	ER 25 A - u-tec
	Gear ratio [i]:	1:2
	Torque max [Nm]:	16
	Rotation max [1/min]:	12000
	Rotating direction:	opposite
	Coolant:	IC/Ext
	Pressure max [bar]:	140
	Please note:	note center distance 55 !
	Center distance [mm]:	55
8 030 35 028	Radial drilling and milling head ER 25 AX UT	
	Weight [kg]:	9.970
	Employment for:	Main spindle
	Tool drive:	Flat (~DIN 1809)
	Shank size [mm]:	32.00
	Shank type:	BMT
	Tool adaption:	ER 25 A - u-tec
	Gear ratio [i]:	1:2
	Torque max [Nm]:	16
	Rotation max [1/min]:	12000
	Rotating direction:	opposite
	Coolant:	EXT
	Please note:	note center distance 55 !
	Center distance [mm]:	55
8 030 36 001	Radial drilling and milling head ER 32	
	Weight [kg]:	10.320
	Tool drive:	Flat (~DIN 1809)
	Shank size [mm]:	32.00
	Shank type:	BMT
	Tool adaption:	ER 32
	Gear ratio [i]:	1:1
	Torque max [Nm]:	50
	Rotation max [1/min]:	12000
	Rotating direction:	opposite
	Coolant:	EXT
	Center distance [mm]:	55
8 030 36 005	Radial drilling and milling head ER 32	
	Weight [kg]:	10.310
	Tool drive:	Flat (~DIN 1809)
	Shank size [mm]:	32.00
	Shank type:	BMT
	Tool adaption:	ER 32
	Gear ratio [i]:	2:1
	Torque max [Nm]:	63
	Rotation max [1/min]:	3000
	Rotating direction:	opposite

Part-#	Name	
	Coolant:	EXT
	Center distance [mm]:	55
8 030 36 011	Radial drilling and milling head ER 32 AX UT	
	Weight [kg]:	10.240
	Tool drive:	Flat (~DIN 1809)
	Shank size [mm]:	32.00
	Shank type:	BMT
	Tool adaption:	ER 32 A - u-tec
	Gear ratio [i]:	1:1
	Torque max [Nm]:	50
	Rotation max [1/min]:	12000
	Rotating direction:	opposite
	Coolant:	EXT
	Center distance [mm]:	55
8 030 36 012	Radial drilling and milling head ER 32 AX UT IC	
	Weight [kg]:	10.470
	Tool drive:	Flat (~DIN 1809)
	Shank size [mm]:	32.00
	Shank type:	BMT
	Tool adaption:	ER 32 A - u-tec
	Gear ratio [i]:	1:1
	Torque max [Nm]:	50
	Rotation max [1/min]:	6000
	Rotating direction:	opposite
	Coolant:	IC/Ext
	Pressure max [bar]:	140
	Center distance [mm]:	55
8 030 36 021	Radial drilling and milling head ER 32 AX UT IC	
	Weight [kg]:	10.450
	Tool drive:	Flat (~DIN 1809)
	Shank size [mm]:	32.00
	Shank type:	BMT
	Tool adaption:	ER 32 A - u-tec
	Gear ratio [i]:	1:1
	Torque max [Nm]:	50
	Rotation max [1/min]:	12000
	Rotating direction:	opposite
	Coolant:	IC/Ext
	Pressure max [bar]:	140
	Center distance [mm]:	55
8 030 37 001	Radial drilling and milling head HT 5 IC	
	Tool drive:	Flat (~DIN 1809)
	Shank size [mm]:	32.00
	Shank type:	BMT
	Tool adaption:	HT 5
	Gear ratio [i]:	1:1
	Torque max [Nm]:	50
	Rotation max [1/min]:	6000
	Rotating direction:	opposite
	Coolant:	IC/Ext
	Pressure max [bar]:	140
	Center distance [mm]:	55

Part-#	Name	
8 030 37 007	Radial drilling and milling head Weldon 1"	
	Weight [kg]:	10.890
	Tool drive:	Flat (~DIN 1809)
	Shank size [mm]:	32.00
	Shank type:	BMT
	Tool adaption:	Weldon (DIN 1835 b) 1" (25,4mm)
	Gear ratio [i]:	2:1
	Torque max [Nm]:	63
	Rotation max [1/min]:	3000
	Rotating direction:	opposite
	Coolant:	EXT
	Center distance [mm]:	55
8 031 36 000	Radial polygon head arbor 27	
	Weight [kg]:	10.860
	Employment for:	Main spindle
	Tool drive:	Flat (~DIN 1809)
	Shank size [mm]:	32.00
	Shank type:	BMT
	Tool adaption:	Polygon arbor 27
	Gear ratio [i]:	1:1
	Torque max [Nm]:	50
	Rotation max [1/min]:	6000
	Rotating direction:	opposite
	Coolant:	EXT
	Please note:	stronger bearing
8 037 34 001	Woodruff keycutter ER 20 AX	
	Tool drive:	Flat (~DIN 1809)
	Shank size [mm]:	32.00
	Shank type:	BMT
	Tool adaption:	ER 20 A
	Gear ratio [i]:	1,333:1
	Torque max [Nm]:	32
	Rotation max [1/min]:	4000
	Rotating direction:	opposite
	Coolant:	EXT
	Center distance [mm]:	75
	Offset [mm]:	8
8 039 35 004	Radial drilling and milling head ER 25 AX UT	
	Weight [kg]:	10.480
	Version:	double spindle
	Tool drive:	Flat (~DIN 1809)
	Shank size [mm]:	32.00
	Shank type:	BMT
	Tool adaption:	ER 25 u-tec
	Gear ratio [i]:	1:1
	Torque max [Nm]:	50
	Rotation max [1/min]:	12000
	Rotating direction:	same/opposite
	Coolant:	EXT
	Center distance [mm]:	55

Part-#

Name

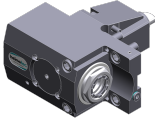
8 039 36 002	Radial drilling and milling head ER 32 AX UT	Weight [kg]: Version: Tool drive: Shank size [mm]: Shank type: Tool adaption: Gear ratio [i]: Torque max [Nm]: Rotation max [1/min]: Rotating direction: Coolant: Center distance [mm]:	10.710 double spindle Flat (~DIN 1809) 32.00 BMT ER 32 u-tec 1:1 50 12000 same/opposite EXT 55
8 039 36 004	Radial drilling and milling head ER 32 AX UT IC	Version: Tool drive: Shank size [mm]: Shank type: Tool adaption: Gear ratio [i]: Torque max [Nm]: Rotation max [1/min]: Rotating direction: Coolant: Pressure max [bar]: Please note: Center distance [mm]:	double spindle Flat (~DIN 1809) 32.00 BMT ER 32 u-tec 1:1 50 10000 same/opposite IC/Ext 70 stronger bearing 55
			
8 040 34 007	Universal head + 99°/-77° adj. ER16 AX UT	Weight [kg]: Tool drive: Shank size [mm]: Shank type: Tool adaption: Gear ratio [i]: Torque max [Nm]: Rotation max [1/min]: Rotating direction: Coolant: Please note: Center distance [mm]:	6.890 Flat (~DIN 1809) 32.00 BMT ER 16 A - u-tec 1:1 20 6000 opposite EXT Note swivel range 34
8 040 34 010	Universal head + 99°/-77° adj. ER16AX UTIK	Weight [kg]: Tool drive: Shank size [mm]: Shank type: Tool adaption: Gear ratio [i]: Torque max [Nm]: Rotation max [1/min]: Rotating direction: Coolant: Pressure max [bar]: Please note: Center distance [mm]:	6.920 Flat (~DIN 1809) 32.00 BMT ER 16 A - u-tec 1:2 12 12000 opposite IC/Ext 25 Note swivel range 34

Part-#	Name	
8 040 34 011	Universal head + 99°/-77° adj. ER20 AX UT	
	Weight [kg]:	7.070
	Tool drive:	Flat (~DIN 1809)
	Shank size [mm]:	32.00
	Shank type:	BMT
	Tool adaption:	ER 20 A - u-tec
	Gear ratio [i]:	1:1
	Torque max [Nm]:	20
	Rotation max [1/min]:	6000
	Rotating direction:	opposite
	Coolant:	EXT
	Please note:	Note swivel range
	Center distance [mm]:	34
8 053 34 014	Multispindle radial head ER 16 AX UT	
	Weight [kg]:	9.860
	Employment for:	Main spindle
	Version:	2-spindles
	Tool drive:	Flat (~DIN 1809)
	Shank size [mm]:	32.00
	Shank type:	BMT
	Tool adaption:	ER 16 A - u-tec
	Gear ratio [i]:	1:2
	Torque max [Nm]:	25/Sp.
	Rotation max [1/min]:	12000
	Rotating direction:	same
	Coolant:	EXT
	Please note:	Check applicability
	Center distance [mm]:	55
8 202 20 013	Basic holder longitudinal seat FN 12	
	Weight [kg]:	1.750
	Shank type:	BMT
	Machine adaption:	Centering key slot b 25
	Tool adaption:	Interface FN 12
	Coolant:	EXT
	Center distance [mm]:	7
8 224 25 000	Universal turning holder sq. 25	
	Weight [kg]:	3.560
	Shank type:	BMT
	Machine adaption:	Centering key slot b 25
	Tool adaption:	Sq. 25
	Coolant:	EXT
8 224 25 001	Universal turning holder sq. 25	
	Weight [kg]:	4.760
	Shank type:	BMT
	Machine adaption:	Centering key slot b 25
	Tool adaption:	Sq. 25
		Sq. 25
	Coolant:	EXT
	Please note:	long version

Part-#	Name	
8 240 29 002	Boring bar holder Ø 40	
	Weight [kg]:	3.920
	Shank type:	BMT
	Machine adaption:	Centering key slot b 25
	Tool adaption:	Ø 40
	Coolant:	IC/Ext
	Center distance [mm]:	40
8 240 29 007	Boring bar holder Ø 40	
	Weight [kg]:	6.180
	Version:	long
	Shank type:	BMT
	Machine adaption:	Centering key slot b 25
	Tool adaption:	Ø 40
	Coolant:	IC/Ext
	Center distance [mm]:	40
8 240 29 021	Boring bar holder Ø 50	
	Weight [kg]:	5.330
	Version:	long version
	Shank type:	BMT
	Machine adaption:	Centering key slot b 25
	Tool adaption:	Ø 50
	Coolant:	IC/Ext
	Center distance [mm]:	40
8 244 25 000	Combi facing holder sq. 25	
	Weight [kg]:	5.900
	Shank type:	BMT
	Machine adaption:	Centering key slot b 25
	Tool adaption:	Sq. 25
	Coolant:	EXT
	Please note:	long version
8 251 25 002	Combi double turning holder sq. 25	
	Weight [kg]:	5.290
	Shank type:	BMT
	Machine adaption:	Centering key slot b 25
	Tool adaption:	Sq. 25 Sq. 25
	Coolant:	EXT
8 253 28 001	Double boring bar holder Ø 32	
	Weight [kg]:	5.680
	Employment for:	Main- and sub spindle
	Shank type:	BMT
	Machine adaption:	Centering key slot b 25
	Tool adaption:	Ø 32 Ø 32
	Coolant:	IC/Ext
	Center distance [mm]:	40/85

CMZ

TC 35 M/MS/Y/YS

heimatec®

Part-#	Name	
8 253 28 006	Double boring bar holder Ø 1 1/4"	
	Weight [kg]:	5.710
	Employment for:	Main- and sub spindle
	Shank type:	BMT
	Machine adaption:	Centering key slot b 25
	Tool adaption:	Ø 1 1/4" (31,75mm)
		Ø 1 1/4" (31,75mm)
	Coolant:	IC/Ext
	Center distance [mm]:	40/85
8 253 28 009	Multiple boring bar holder Ø 32	
	Weight [kg]:	7.930
	Employment for:	Main- and sub spindle
	Version:	double spindle
	Shank type:	BMT
	Machine adaption:	Centering key slot b 25
	Tool adaption:	Ø 32
		Ø 32
		Ø 32
		Ø 32
	Coolant:	IC/Ext
	Center distance [mm]:	40/ 85



heimatec.u-tec®

heimatec.com

Products / Tool change systems /
u-tec® Tool-changing system



versions see catalog

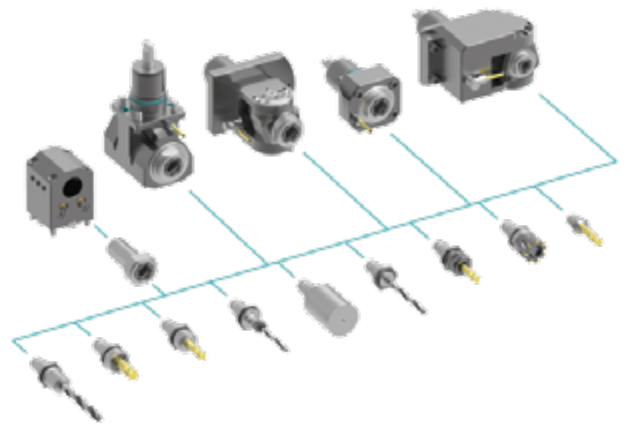

heimatec.easy-quick

heimatec.com

Products / Tool change systems /
easy-quick HT quick-changing system



versions see catalog

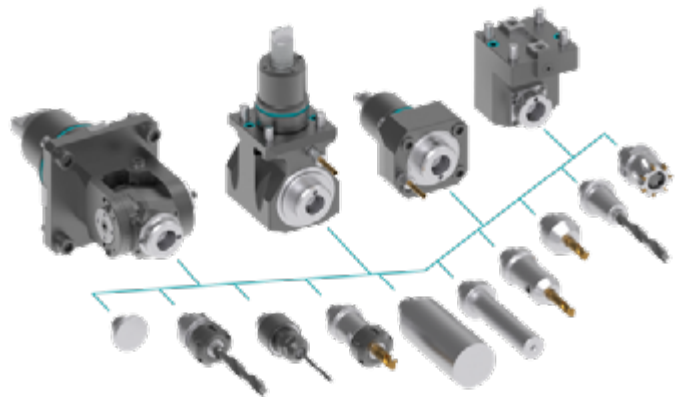

heimatec.Capto™

heimatec.com

Products / Tool change systems /
heimatec.Capto™ quick-changing system



versions see catalog

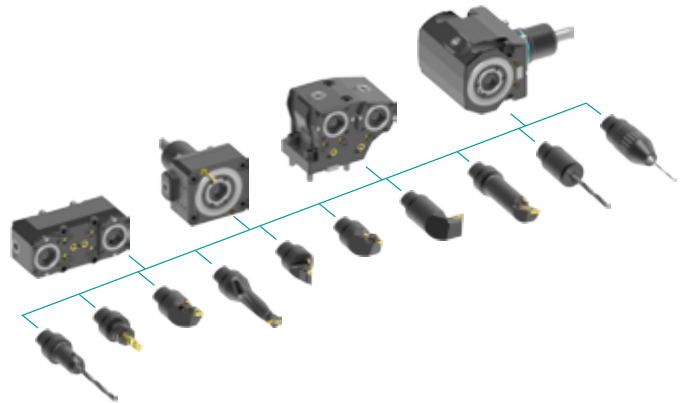

heimatec.accessories

heimatec.com

Products / Accessories



versions see catalog





● heimatec overseas branches

○ global representations of heimatec

heimatec[®]

heimatec GmbH
Präzisionswerkzeuge
Carl-Benz-Str. 4
77871 Renchen
Germany

T +49 7843 9466 0
www.heimatec.com
info@heimatec.com

Please find the contact details of our worldwide trading partners on our website:
<https://heimatec.com/business-partners>