

Okuma

**LU 3000 EX**

**MW/MYW - BMT**



# High-tech from heimatec - heimatec - Tools and systems for productive turning and milling

heimatec belongs to the international technology and quality leaders for precision tools and specializes in the development and production of high-precision static and live tools for all CNC lathes, CNC turn-/mill machines and CNC machining centers.

The range of products\* spans from static BMT and VDI tool holders, live tools up to highly complex customer-specific individual solutions. heimatec, headquartered in Renchen, has a own subsidiary in Asia and India and numerous representatives as well as trading partners all over the world.

## \*OUR PRODCUTS

Static tool holders

Live tool units

Precision tools

Tools for turning and machining centres

Tools for swiss type lathes

Tool changing and uick-change systems

Tool systems for gear production



Digital tool management

This catalogue, including all its parts, is protected by copyright. Any use outside the restricted limitations of the Copyright Act without the consent of heimatec is inadmissible and liable to prosecution. This applies in particular to duplication, translation, microfilming and storage and processing in electronic systems.

**heimatec GmbH** reserves the right to make technical changes at any time without giving prior notice. This applies in particular to adjustments at any time to meet new or changed international standards, or in case of further developments of our products or manufacturing processes.

The current version of our General Terms and Conditions can be found on our website.

Part-#	Name	
<b>8 010 66 071</b>	<b>Axial drilling and milling head ER 32 AX UT</b>	
	Weight [kg]:	3.840
	Tool drive:	Flat (~DIN 1809)
	Shank size [mm]:	60.00
	Shank type:	BMT
	Tool adaption:	ER 32 A - u-tec
	Gear ratio [i]:	1:1
	Torque max [Nm]:	70
	Rotation max [1/min]:	6000
	Rotating direction:	same
	Coolant:	EXT
	Please note:	Combi bearing
<b>8 010 66 072</b>	<b>Axial drilling and milling head ER 32 AX UT IC</b>	
	Weight [kg]:	3.810
	Tool drive:	Flat (~DIN 1809)
	Shank size [mm]:	60.00
	Shank type:	BMT
	Tool adaption:	ER 32 A - u-tec
	Gear ratio [i]:	1:1
	Torque max [Nm]:	70
	Rotation max [1/min]:	6000
	Rotating direction:	same
	Coolant:	IC/Ext
	Pressure max [bar]:	25
	Please note:	Combi bearing
<b>8 010 66 073</b>	<b>Axial drilling and milling head ER 32 AX UT IC</b>	
	Tool drive:	Flat (~DIN 1809)
	Shank size [mm]:	60.00
	Shank type:	BMT
	Tool adaption:	ER 32 A - u-tec
	Gear ratio [i]:	1:1
	Torque max [Nm]:	70
	Rotation max [1/min]:	6000
	Rotating direction:	same
	Coolant:	IC/Ext
	Pressure max [bar]:	100
	Please note:	Combi bearing; dryrun possible
<b>8 010 67 034</b>	<b>Axial drilling and milling head HT 5 IC</b>	
	Tool drive:	Flat (~DIN 1809)
	Shank size [mm]:	60.00
	Shank type:	BMT
	Tool adaption:	HT 5
	Gear ratio [i]:	1:1
	Torque max [Nm]:	70
	Rotation max [1/min]:	6000
	Rotating direction:	same
	Coolant:	IC/Ext
	Pressure max [bar]:	25
	Please note:	Combi bearing

Part-#	Name	
<b>8 011 66 013</b>	<b>Axial milling head universal arbor 27</b>	
	Weight [kg]:	4.050
	Tool drive:	Flat (~DIN 1809)
	Shank size [mm]:	60.00
	Shank type:	BMT
	Tool adaption:	Universal arbor 27
	Gear ratio [i]:	1:1
	Torque max [Nm]:	70
	Rotation max [1/min]:	6000
	Rotating direction:	same
	Coolant:	EXT
	Please note:	Combi bearing
<b>8 019 66 009</b>	<b>Axial drilling and milling head ER 32 AX UT</b>	
	Notation:	offset; 180° reversible
	Tool drive:	Flat (~DIN 1809)
	Shank size [mm]:	60.00
	Shank type:	BMT
	Tool adaption:	ER 32 A - u-tec
	Gear ratio [i]:	1:1
	Torque max [Nm]:	50
	Rotation max [1/min]:	6000
	Rotating direction:	opposite
	Coolant:	EXT
	Please note:	stronger bearing
	Offset [mm]:	50
<b>8 030 66 091</b>	<b>Radial drilling and milling head ER 32 AX UT</b>	
	Notation:	180° reversible
	Tool drive:	Flat (~DIN 1809)
	Shank size [mm]:	60.00
	Shank type:	BMT
	Tool adaption:	ER 32 A - u-tec
	Gear ratio [i]:	2:1
	Torque max [Nm]:	63
	Rotation max [1/min]:	3000
	Rotating direction:	opposite
	Coolant:	EXT
	Please note:	Note reverse rotation! combi bearing
	Center distance [mm]:	70
<b>8 030 66 271</b>	<b>Radial drilling and milling head ER 32 AX UT</b>	
	Weight [kg]:	7.780
	Notation:	180° reversible
	Tool drive:	Flat (~DIN 1809)
	Shank size [mm]:	60.00
	Shank type:	BMT
	Tool adaption:	ER 32 A - u-tec
	Gear ratio [i]:	1:1
	Torque max [Nm]:	70
	Rotation max [1/min]:	10000
	Rotating direction:	same
	Coolant:	EXT
	Center distance [mm]:	70



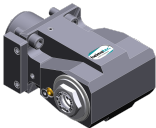

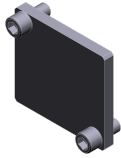
Part-#	Name		
	<b>8 030 66 272</b>	<b>Radial drilling and milling head ER 32 AX UT IC</b>	
		Weight [kg]:	8.250
		Notation:	180° reversible
		Tool drive:	Flat (~DIN 1809)
		Shank size [mm]:	60.00
		Shank type:	BMT
		Tool adaption:	ER 32 A - u-tec
		Gear ratio [i]:	1:1
		Torque max [Nm]:	70
		Rotation max [1/min]:	10000
		Rotating direction:	same
		Coolant:	IC/Ext
		Pressure max [bar]:	140
		Center distance [mm]:	70
	<b>8 030 67 038</b>	<b>Radial drilling and milling head HT 5</b>	
		Weight [kg]:	7.400
		Notation:	180° reversible
		Tool drive:	Flat (~DIN 1809)
		Shank size [mm]:	60.00
		Shank type:	BMT
		Tool adaption:	HT 5
		Gear ratio [i]:	1:1
		Torque max [Nm]:	70
		Rotation max [1/min]:	6000
		Rotating direction:	same
		Coolant:	EXT
		Please note:	stronger bearing
		Center distance [mm]:	70
	<b>8 030 67 039</b>	<b>Radial drilling and milling head HT 5 IC</b>	
		Weight [kg]:	8.070
		Notation:	180° reversible
		Tool drive:	Flat (~DIN 1809)
		Shank size [mm]:	60.00
		Shank type:	BMT
		Tool adaption:	HT 5
		Gear ratio [i]:	1:1
		Torque max [Nm]:	70
		Rotation max [1/min]:	6000
		Rotating direction:	same
		Coolant:	IC/Ext
		Pressure max [bar]:	140
		Please note:	stronger bearing
	Center distance [mm]:	70	
	<b>8 031 64 005</b>	<b>Radial polygon head arbor 16</b>	
		Notation:	180° reversible
		Tool drive:	Flat (~DIN 1809)
		Shank size [mm]:	60.00
		Shank type:	BMT
		Tool adaption:	Polygon arbor 16
		Gear ratio [i]:	1:1
		Torque max [Nm]:	50
		Rotation max [1/min]:	6000
		Rotating direction:	opposite
		Coolant:	EXT
		Please note:	Combi bearing; reverse rotation note

Part-#	Name	
	Center distance [mm]:	70
<b>8 037 64 026</b>	<b>Radial disk mill head arbor 3/4"</b>	
	Weight [kg]:	7.990
	Version:	± 50° turnable; special
	Tool drive:	Flat (~DIN 1809)
	Shank size [mm]:	60.00
	Shank type:	BMT
	Tool adaption:	Arbor 3/4" (19,05mm)
	Gear ratio [i]:	1:1
	Torque max [Nm]:	40
	Rotation max [1/min]:	4000
	Rotating direction:	opposite
	Coolant:	no
	Center distance [mm]:	92
<b>8 037 64 036</b>	<b>Radial disk mill head arbor 3/4"</b>	
	Version:	± 50° turnable
	Tool drive:	Flat (~DIN 1809)
	Shank size [mm]:	60.00
	Shank type:	BMT
	Tool adaption:	Arbor 3/4" (19,05mm)
	Gear ratio [i]:	1:1
	Torque max [Nm]:	40
	Rotation max [1/min]:	4000
	Rotating direction:	opposite
	Coolant:	no
	Center distance [mm]:	92
<b>8 037 64 038</b>	<b>Radial disk mill head arbor 3/4"</b>	
	Weight [kg]:	8.110
	Version:	± 45° turnable; special
	Tool drive:	Flat (~DIN 1809)
	Shank size [mm]:	60.00
	Shank type:	BMT
	Tool adaption:	Arbor 3/4" (19,05mm)
	Gear ratio [i]:	1:1
	Torque max [Nm]:	40
	Rotation max [1/min]:	4000
	Rotating direction:	opposite
	Coolant:	no
	Please note:	Check applicability!
	Center distance [mm]:	92
<b>8 039 65 016</b>	<b>Radial drilling and milling head ER 25 AX UT</b>	
	Weight [kg]:	9.950
	Notation:	180° reversible
	Employment for:	Main- and sub spindle
	Version:	double spindle
	Tool drive:	Flat (~DIN 1809)
	Shank size [mm]:	60.00
	Shank type:	BMT
	Tool adaption:	ER 25 A - u-tec
	Gear ratio [i]:	1:1
	Torque max [Nm]:	70
	Rotation max [1/min]:	6000
	Rotating direction:	same/opposite

Part-#	Name	
	Coolant:	EXT
	Please note:	stronger bearing
	Center distance [mm]:	110
<b>8 039 66 027</b>	<b>Radial drilling and milling head ER 32 AX UT</b>	
	Weight [kg]:	7.910
	Notation:	180° reversible
	Employment for:	Main- and sub spindle
	Version:	double spindle
	Tool drive:	Flat (~DIN 1809)
	Shank size [mm]:	60.00
	Shank type:	BMT
	Tool adaption:	ER 32 A - u-tec
	Gear ratio [i]:	1:1
	Torque max [Nm]:	70
	Rotation max [1/min]:	6000
	Rotating direction:	same/opposite
	Coolant:	EXT
	Please note:	stronger bearing
	Center distance [mm]:	70
<b>8 200 63 000</b>	<b>Cover plate 91,0x100,0x 10,0</b>	
	Weight [kg]:	0.830
	Shank size [mm]:	60.00
	Shank type:	BMT
<b>8 202 00 015</b>	<b>Basic holder longitudinal seat FN 12</b>	
	Weight [kg]:	1.560
	Shank type:	BMT
	Machine adaption:	Centering key slot b 15
	Tool adaption:	Interface FN 12
	Coolant:	EXT
	Center distance [mm]:	16
<b>8 202 00 026</b>	<b>Basic holder longitudinal seat FN 12</b>	
	Weight [kg]:	1.910
	Shank type:	BMT
	Machine adaption:	Centering key slot b 15
	Tool adaption:	Interface FN 12
	Coolant:	EXT
	Center distance [mm]:	34,5
<b>8 209 04 000</b>	<b>Adapter for VDI 40</b>	
	Weight [kg]:	5.280
	Notation:	180° reversible; offset
	Shank type:	BMT
	Machine adaption:	Centering key slot b 15
	Tool adaption:	DIN 69880 - 40
	Coolant:	EXT
	Center distance [mm]:	90

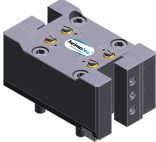
Part-#	Name	
<b>8 224 03 000</b>	<b>Cut-off holder SH 32</b>	
	Weight [kg]:	2.540
	Employment for:	Cut-off tool 32
	Version:	Clampshaft on turret side
	Shank type:	BMT
	Machine adaption:	Centering key slot b 15
	Tool adaption:	Clampshaft SH 32
	Coolant:	EXT
<b>8 224 03 001</b>	<b>Cut-off holder SH 32</b>	
	Weight [kg]:	2.300
	Employment for:	Cut-off tool 32
	Version:	Clampshaft on turret center
	Shank type:	BMT
	Machine adaption:	Centering key slot b 15
	Tool adaption:	Clampshaft SH 32
	Coolant:	EXT
<b>8 224 05 001</b>	<b>Universal turning holder sq. 25</b>	
	Weight [kg]:	4.360
	Shank type:	BMT
	Machine adaption:	Centering key slot b 15
	Tool adaption:	Sq. 25
	Coolant:	EXT
<b>8 224 05 004</b>	<b>Universal turning holder sq. 1"</b>	
	Weight [kg]:	4.340
	Shank type:	BMT
	Machine adaption:	Centering key slot b 15
	Tool adaption:	Sq. 1" (25,4mm)
		Sq. 1" (25,4mm)
	Coolant:	EXT
<b>8 240 06 001</b>	<b>Tool holder C 4 IC</b>	
	Weight [kg]:	5.980
	Notation:	180° reversible
	Shank type:	BMT
	Machine adaption:	Centering key slot b 15
	Tool adaption:	heimatec Capto(TM) C 4
	Coolant:	IC/Ext
	Center distance [mm]:	90
<b>8 240 06 007</b>	<b>Collet chuck holder ER 32</b>	
	Weight [kg]:	6.500
	Notation:	180° reversible
	Shank type:	BMT
	Machine adaption:	Centering key slot b 15
	Tool adaption:	ER 32
	Coolant:	IC/Ext
	Center distance [mm]:	90

Part-#	Name	
<b>8 240 08 001</b>	<b>Boring bar holder Ø 32</b>	
	Weight [kg]:	5.920
	Notation:	180° reversible
	Shank type:	BMT
	Machine adaption:	Centering key slot b 15
	Tool adaption:	Ø 32
	Coolant:	IC/Ext
	Center distance [mm]:	90
<b>8 240 08 007</b>	<b>Boring bar holder Ø 1 1/2"</b>	
	Weight [kg]:	5.720
	Notation:	180° reversible
	Shank type:	BMT
	Machine adaption:	Centering key slot b 15
	Tool adaption:	Ø 1 1/2" (38,1mm)
	Coolant:	IC/Ext
	Center distance [mm]:	90
<b>8 240 09 007</b>	<b>Boring bar holder Ø 40</b>	
	Weight [kg]:	5.640
	Notation:	180° reversible
	Shank type:	BMT
	Machine adaption:	Centering key slot b 15
	Tool adaption:	Ø 40
	Coolant:	IC/Ext
	Center distance [mm]:	90
<b>8 244 05 001</b>	<b>Combi facing holder sq. 25</b>	
	Weight [kg]:	6.160
	Employment for:	Main- and sub spindle
	Shank type:	BMT
	Machine adaption:	Centering key slot b 15
	Tool adaption:	Sq. 25
	Coolant:	EXT
	Please note:	only with MW machines for sub spindle
<b>8 244 05 011</b>	<b>Combi facing holder sq. 25</b>	
	Weight [kg]:	9.125
	Employment for:	Main- and sub spindle
	Shank type:	BMT
	Machine adaption:	Centering key slot b 15
	Tool adaption:	Sq. 25
		Sq. 25
	Coolant:	EXT
	Please note:	only with MW machines for sub spindle
<b>8 251 05 000</b>	<b>Combi double turning holder sq. 25</b>	
	Weight [kg]:	6.760
	Employment for:	Main- and sub spindle
	Shank type:	BMT
	Machine adaption:	Centering key slot b 15
	Tool adaption:	Sq. 25
	Coolant:	EXT

Part-#	Name	
<b>8 251 05 002</b>	<b>Combi double turning holder sq. 1"</b>	
	Weight [kg]:	6.770
	Employment for:	Main- and sub spindle
	Shank type:	BMT
	Machine adaption:	Centering key slot b 15
	Tool adaption:	Sq. 1" (25,4mm)
	Coolant:	EXT
<b>8 251 05 011</b>	<b>Combi double turning holder sq. 25 IC</b>	
	Weight [kg]:	6.940
	Employment for:	Main- and sub spindle
	Shank type:	BMT
	Machine adaption:	Centering key b 15
	Tool adaption:	Sq. 25
		Sq. 25
		Sq. 25
	Coolant:	IC/Ext
	Pressure max [bar]:	100
<b>8 253 08 000</b>	<b>Double boring bar holder Ø 1 1/2"</b>	
	Weight [kg]:	7.650
	Employment for:	Main- and sub spindle
	Shank type:	BMT
	Machine adaption:	Centering key slot b 15
	Tool adaption:	Ø 1 1/2" (38,1mm)
	Coolant:	IC/Ext
	Center distance [mm]:	50/105
<b>8 253 09 000</b>	<b>Double boring bar holder Ø 40</b>	
	Weight [kg]:	7.450
	Employment for:	Main- and sub spindle
	Shank type:	BMT
	Machine adaption:	Centering key slot b 15
	Tool adaption:	Ø 40
	Coolant:	IC/Ext
	Center distance [mm]:	50/105
<b>8 320 03 014</b>	<b>Cut-off holder, height adjustable SH 32 IC</b>	
	Weight [kg]:	2.190
	Shank type:	BMT
	Machine adaption:	Centering key slot b 15
	Tool adaption:	Clampshaft SH 32
	Coolant:	IC/Ext
	Pressure max [bar]:	70
<b>8 320 09 005</b>	<b>Cut-off holder, height adjustable 845 IC</b>	
	Shank type:	BMT
	Machine adaption:	Centering key slot b 15
	Tool adaption:	 System 845
	Coolant:	IC
	Pressure max [bar]:	70

## heimatec.u-tec®

heimatec.com

Products / Tool change systems /  
u-tec® Tool-changing system



versions see catalog

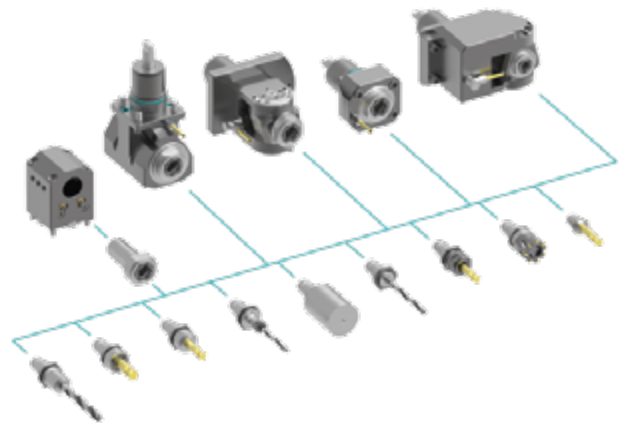

## heimatec.easy-quick

heimatec.com

Products / Tool change systems /  
easy-quick HT quick-changing system



versions see catalog

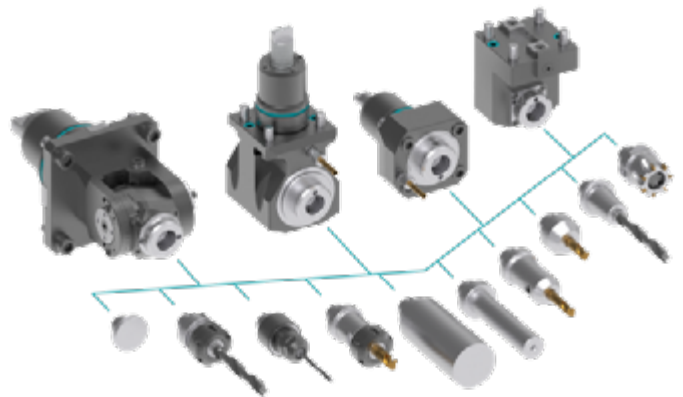

## heimatec.Capto™

heimatec.com

Products / Tool change systems /  
heimatec.Capto™ quick-changing system



versions see catalog

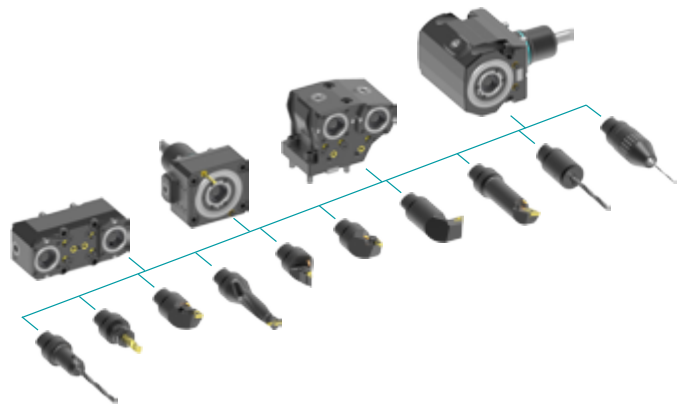

## heimatec.accessories

heimatec.com

Products / Accessories



versions see catalog





● heimatec overseas branches

○ global representations of heimatec

**heimatec**<sup>®</sup>

**heimatec GmbH**  
Präzisionswerkzeuge  
Carl-Benz-Str. 4  
77871 Renchen  
Germany

T +49 7843 9466 0  
[www.heimatec.com](http://www.heimatec.com)  
[info@heimatec.com](mailto:info@heimatec.com)

Please find the contact details of our worldwide trading partners on our website:  
<https://heimatec.com/business-partners>