

Okuma

LU 4000 EX

M/MY - BMT



High-tech from heimatec - heimatec - Tools and systems for productive turning and milling

heimatec belongs to the international technology and quality leaders for precision tools and specializes in the development and production of high-precision static and live tools for all CNC lathes, CNC turn-/mill machines and CNC machining centers.

The range of products* spans from static BMT and VDI tool holders, live tools up to highly complex customer-specific individual solutions. heimatec, headquartered in Renchen, has a own subsidiary in Asia and India and numerous representatives as well as trading partners all over the world.

*OUR PRODCUTS

Static tool holders

Live tool units

Precision tools

Tools for turning and machining centres

Tools for swiss type lathes

Tool changing and uick-change systems



Tool systems for gear production



Digital tool management

This catalogue, including all its parts, is protected by copyright. Any use outside the restricted limitations of the Copyright Act without the consent of heimatec is inadmissible and liable to prosecution. This applies in particular to duplication, translation, microfilming and storage and processing in electronic systems.

heimatec GmbH reserves the right to make technical changes at any time without giving prior notice. This applies in particular to adjustments at any time to meet new or changed international standards, or in case of further developments of our products or manufacturing processes.

The current version of our General Terms and Conditions can be found on our website.

Part-#	Name	
8 010 67 036	Axial drilling and milling head ER 40	
	Weight [kg]:	4.330
	Tool drive:	Flat (~DIN 1809)
	Shank size [mm]:	60.00
	Shank type:	BMT
	Tool adaption:	ER 40
	Gear ratio [i]:	1:1
	Torque max [Nm]:	80
	Rotation max [1/min]:	6000
	Rotating direction:	same
	Coolant:	EXT
8 010 67 040	Axial drilling and milling head HT 5	
	Tool drive:	Flat (~DIN 1809)
	Shank size [mm]:	60.00
	Shank type:	BMT
	Tool adaption:	HT 5
	Gear ratio [i]:	1:1
	Torque max [Nm]:	80
	Rotation max [1/min]:	6000
	Rotating direction:	same
	Coolant:	EXT
8 202 00 017	Basic holder longitudinal seat FN 12	
	Shank type:	BMT
	Machine adaption:	Centering key slot b 15
	Tool adaption:	Interface FN 12
	Coolant:	EXT
	Center distance [mm]:	25
8 224 03 002	Cut-off holder SH 32	
	Weight [kg]:	2.690
	Employment for:	Cut-off tool 32
	Version:	Clampshaft on turret side
	Shank type:	BMT
	Machine adaption:	Centering key slot b 15
	Tool adaption:	Clampshaft SH 32
	Coolant:	EXT
8 224 05 002	Universal turning holder sq. 25	
	Weight [kg]:	4.980
	Shank type:	BMT
	Machine adaption:	Centering key slot b 15
	Tool adaption:	Sq. 25
		Sq. 25
	Coolant:	EXT
8 224 05 006	Universal turning holder sq. 1"	
	Weight [kg]:	4.970
	Shank type:	BMT
	Machine adaption:	Centering key slot b 15
	Tool adaption:	Sq. 1" (25,4mm)
		Sq. 1" (25,4mm)
	Coolant:	EXT

Part-#	Name	
8 240 09 008	Boring bar holder Ø 40	
	Weight [kg]:	6.030
	Notation:	180° reversible
	Shank type:	BMT
	Machine adaption:	Centering key slot b 15
	Tool adaption:	Ø 40
	Coolant:	IC/Ext
	Center distance [mm]:	90
8 240 09 010	Boring bar holder Ø 50	
	Weight [kg]:	7.810
	Notation:	180° reversible
	Shank type:	BMT
	Machine adaption:	Centering key slot b 15
	Tool adaption:	Ø 50
	Coolant:	IC/Ext
	Center distance [mm]:	90
8 240 09 048	Boring bar holder Ø 40 - slotted	
	Notation:	180° reversible
	Version:	slotted
	Shank type:	BMT
	Machine adaption:	Centering key slot b 15
	Tool adaption:	Ø 40
	Coolant:	EXT
	Pressure max [bar]:	100
	Center distance [mm]:	90
8 244 05 002	Combi facing holder sq. 25	
	Shank type:	BMT
	Machine adaption:	Centering key slot b 15
	Tool adaption:	Sq. 25
		Sq. 25
	Coolant:	EXT

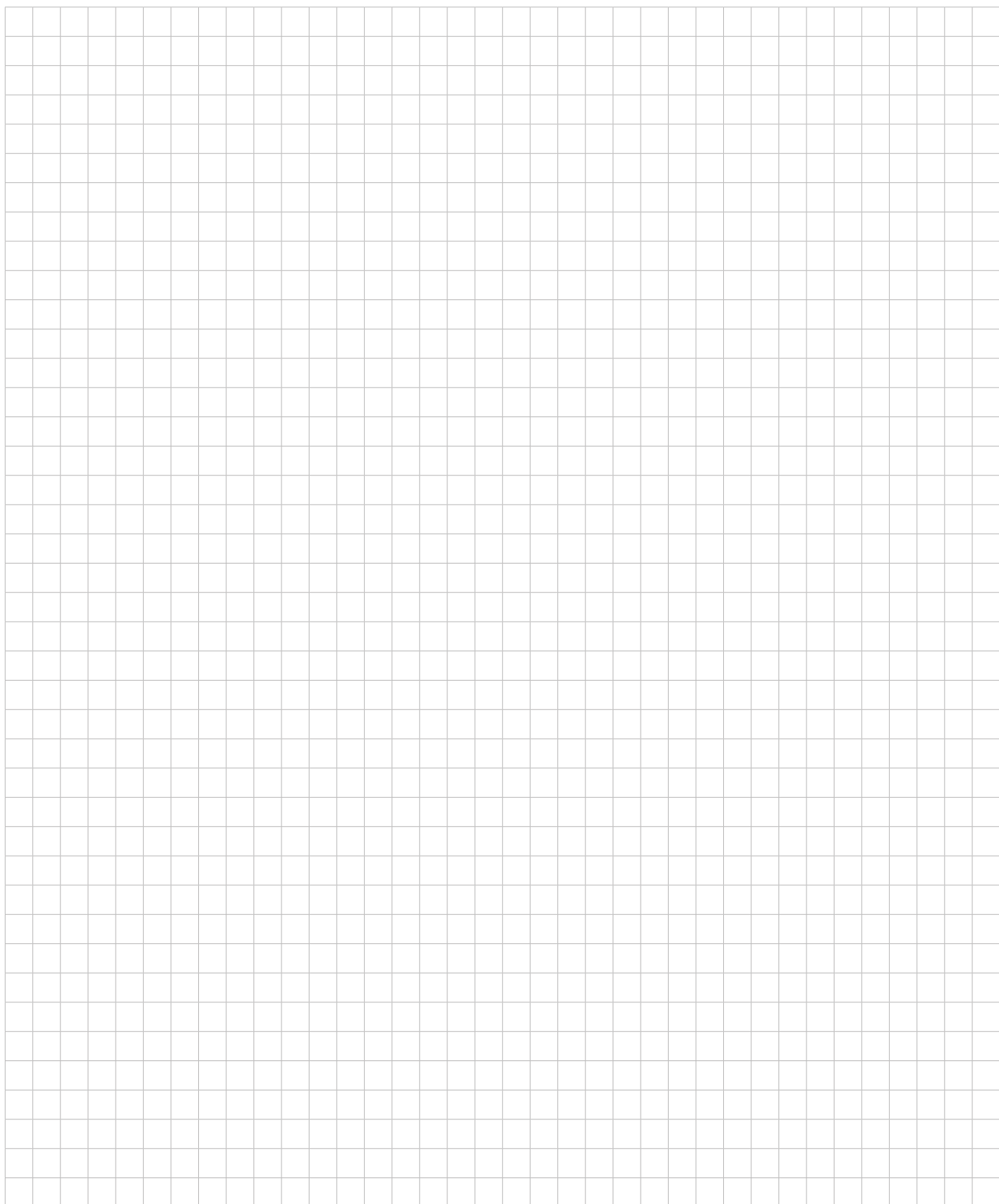

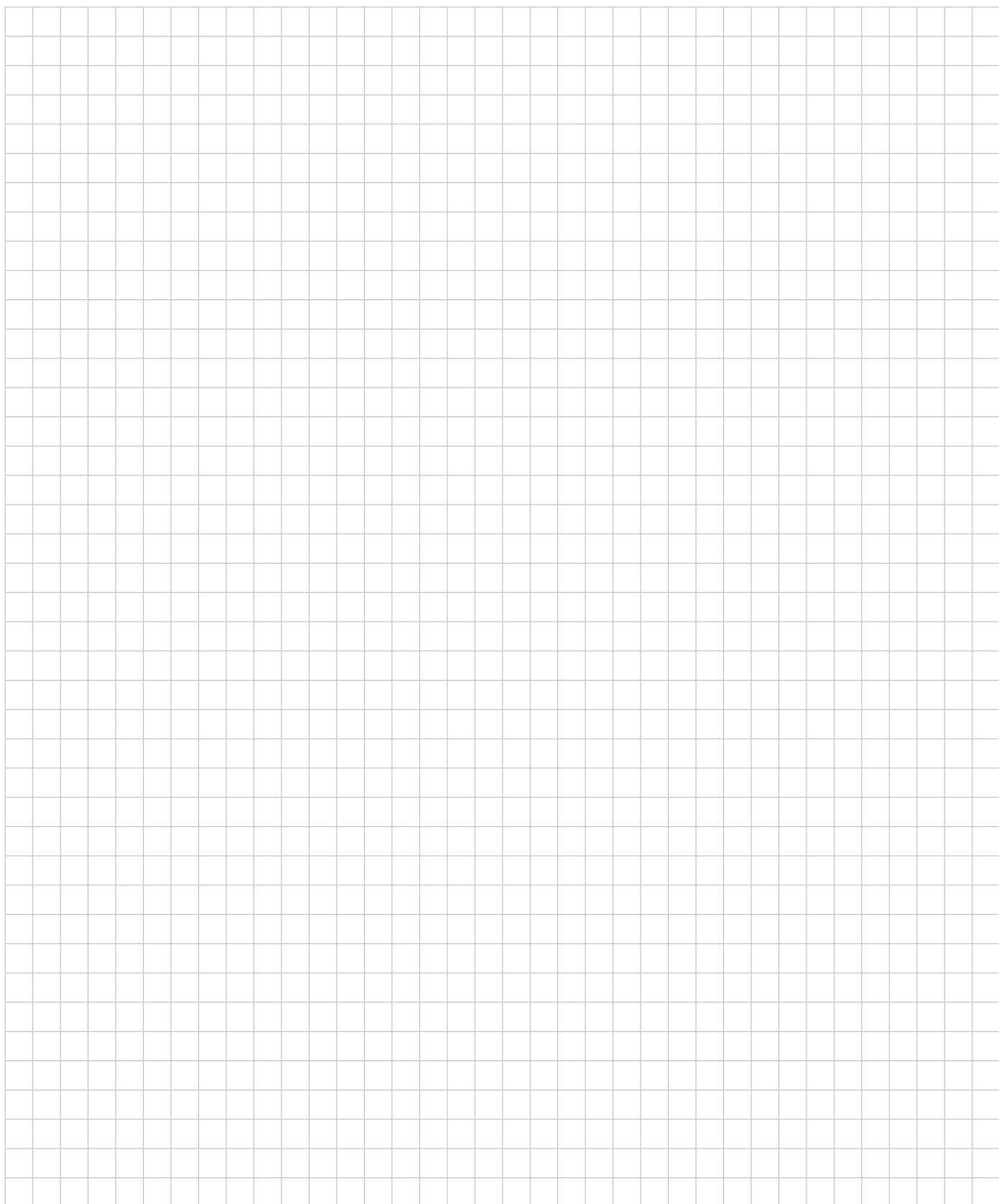

heimatec.u-tec®

heimatec.com

Products / Tool change systems /
u-tec® Tool-changing system



versions see catalog



heimatec.easy-quick

heimatec.com

Products / Tool change systems /
easy-quick HT quick-changing system



versions see catalog



heimatec.Capto™

heimatec.com

Products / Tool change systems /
heimatec.Capto™ quick-changing system



versions see catalog

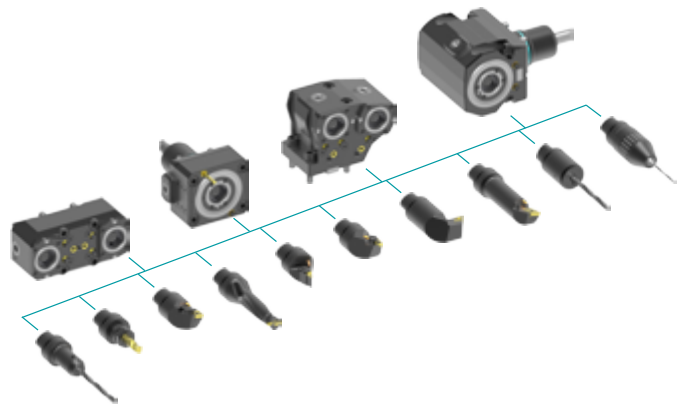

heimatec.accessories

heimatec.com

Products / Accessories



versions see catalog





● heimatec overseas branches

○ global representations of heimatec

heimatec[®]

heimatec GmbH
Präzisionswerkzeuge
Carl-Benz-Str. 4
77871 Renchen
Germany

T +49 7843 9466 0
www.heimatec.com
info@heimatec.com

Please find the contact details of our worldwide trading partners on our website:
<https://heimatec.com/business-partners>