

Okuma
Space turn LB
300



High-tech from heimatec - heimatec - Tools and systems for productive turning and milling

heimatec belongs to the international technology and quality leaders for precision tools and specializes in the development and production of high-precision static and live tools for all CNC lathes, CNC turn-/mill machines and CNC machining centers.

The range of products* spans from static BMT and VDI tool holders, live tools up to highly complex customer-specific individual solutions. heimatec, headquartered in Renchen, has a own subsidiary in Asia and India and numerous representatives as well as trading partners all over the world.

*OUR PRODCUTS

Static tool holders

Live tool units

Precision tools

Tools for turning and machining centres

Tools for swiss type lathes

Tool changing and uick-change systems

Tool systems for gear production

Digital tool management

This catalogue, including all its parts, is protected by copyright. Any use outside the restricted limitations of the Copyright Act without the consent of heimatec is inadmissible and liable to prosecution. This applies in particular to duplication, translation, microfilming and storage and processing in electronic systems.

heimatec GmbH reserves the right to make technical changes at any time without giving prior notice. This applies in particular to adjustments at any time to meet new or changed international standards, or in case of further developments of our products or manufacturing processes.

The current version of our General Terms and Conditions can be found on our website.

Part-#	Name	
8 010 46 189	Axial drilling and milling head ER 32 AX UT IC	
	Weight [kg]:	3.650
	Tool drive:	Coupling
	Shank size [mm]:	40.00
	Shank type:	VDI
	Tool adaption:	ER 32 A - u-tec
	Gear ratio [i]:	1:1
	Torque max [Nm]:	50
	Rotation max [1/min]:	6000
	Rotating direction:	same
	Coolant:	IC/Ext
	Pressure max [bar]:	25
	Please note:	round housing Ø 84
8 010 46 190	Axial drilling and milling head ER 32 AX UT	
	Weight [kg]:	3.460
	Tool drive:	Coupling
	Shank size [mm]:	40.00
	Shank type:	VDI
	Tool adaption:	ER 32 A - u-tec
	Gear ratio [i]:	1:1
	Torque max [Nm]:	50
	Rotation max [1/min]:	6000
	Rotating direction:	same
	Coolant:	EXT
	Please note:	round housing ø 84
8 010 46 191	Axial drilling and milling head ER 32	
	Weight [kg]:	3.490
	Tool drive:	Coupling
	Shank size [mm]:	40.00
	Shank type:	VDI
	Tool adaption:	ER 32
	Gear ratio [i]:	1:1
	Torque max [Nm]:	50
	Rotation max [1/min]:	6000
	Rotating direction:	same
	Coolant:	EXT
	Please note:	round housing Ø 84
8 010 46 192	Axial drilling and milling head ER 32 IC	
	Weight [kg]:	3.720
	Tool drive:	Coupling
	Shank size [mm]:	40.00
	Shank type:	VDI
	Tool adaption:	ER 32
	Gear ratio [i]:	1:1
	Torque max [Nm]:	50
	Rotation max [1/min]:	6000
	Rotating direction:	same
	Coolant:	IC/Ext
	Pressure max [bar]:	25
	Please note:	round housing Ø 84

Part-#	Name	
8 010 47 095	Axial drilling and milling head HT 5	
	Weight [kg]:	3.450
	Tool drive:	Coupling
	Shank size [mm]:	40.00
	Shank type:	VDI
	Tool adaption:	HT 5
	Gear ratio [i]:	1:1
	Torque max [Nm]:	50
	Rotation max [1/min]:	6000
	Rotating direction:	same
	Coolant:	EXT
	Please note:	Round housing ø84
8 010 47 096	Axial drilling and milling head HT 5 IC	
	Tool drive:	Coupling
	Shank size [mm]:	40.00
	Shank type:	VDI
	Tool adaption:	HT 5
	Gear ratio [i]:	1:1
	Torque max [Nm]:	50
	Rotation max [1/min]:	6000
	Rotating direction:	same
	Coolant:	IC/Ext
	Pressure max [bar]:	25
	Please note:	round housing ø 84
8 010 47 119	Axial drilling and milling head ER 40	
	Weight [kg]:	3.700
	Tool drive:	Coupling
	Shank size [mm]:	40.00
	Shank type:	VDI
	Tool adaption:	ER 40
	Gear ratio [i]:	1:1
	Torque max [Nm]:	50
	Rotation max [1/min]:	6000
	Rotating direction:	same
	Coolant:	EXT
	Please note:	stronger bearing; round housing ø 84
8 013 46 003	Axial drilling and milling head ER 32	
	Weight [kg]:	7.420
	Tool drive:	Coupling
	Shank size [mm]:	40.00
	Shank type:	VDI
	Tool adaption:	ER 32
	Gear ratio [i]:	3:1
	Torque max [Nm]:	75
	Rotation max [1/min]:	3000
	Rotating direction:	same
	Coolant:	EXT
8 013 46 006	Axial drilling and milling head ER 32 IC	
	Weight [kg]:	7.460
	Tool drive:	Coupling
	Shank size [mm]:	40.00
	Shank type:	VDI
	Tool adaption:	ER 32
	Gear ratio [i]:	3:1

Part-#	Name	
	Torque max [Nm]:	75
	Rotation max [1/min]:	3000
	Rotating direction:	same
	Coolant:	IC/Ext
8 019 45 066	Axial mill and grind holder arbor 22	
	Weight [kg]:	9.640
	Notation:	offset
	Employment for:	Main spindle
	Tool drive:	Coupling
	Shank size [mm]:	40.00
	Shank type:	VDI
	Tool adaption:	Arbor 22
	Gear ratio [i]:	1:3
	Torque max [Nm]:	12
	Rotation max [1/min]:	15000
	Rotating direction:	opposite
	Coolant:	EXT
	Please note:	with special spindle cooling !!!
	Offset [mm]:	50
8 019 45 114	Axial drilling and milling head ER 25 AX UT	
	Notation:	offset
	Version:	left
	Tool drive:	Coupling
	Shank size [mm]:	40.00
	Shank type:	VDI
	Tool adaption:	ER 25 A - u-tec
	Gear ratio [i]:	1:2
	Torque max [Nm]:	40
	Rotation max [1/min]:	12000
	Rotating direction:	opposite
	Coolant:	EXT
	Please note:	stronger bearing
	Offset [mm]:	50
8 019 46 096	Axial drilling and milling head ER 32	
	Weight [kg]:	7.410
	Notation:	offset
	Version:	left
	Tool drive:	Coupling
	Shank size [mm]:	40.00
	Shank type:	VDI
	Tool adaption:	ER 32
	Gear ratio [i]:	1:1
	Torque max [Nm]:	50
	Rotation max [1/min]:	6000
	Rotating direction:	opposite
	Coolant:	EXT
	Please note:	stronger bearing
	Offset [mm]:	50

Part-#	Name	
8 019 46 281	Axial drilling and milling head ER 32 AX UT	
	Weight [kg]:	8.050
	Notation:	offset
	Employment for:	Main spindle
	Version:	left
	Tool drive:	Coupling
	Shank size [mm]:	40.00
	Shank type:	VDI
	Tool adaption:	ER 32 A - u-tec
	Gear ratio [i]:	1:1
	Torque max [Nm]:	50
	Rotation max [1/min]:	4000
	Rotating direction:	same
	Coolant:	EXT
	Please note:	stronger bearing
	Offset [mm]:	65
8 030 44 008	Radial drilling and milling head Weldon 12	
	Weight [kg]:	6.600
	Tool drive:	Coupling
	Shank size [mm]:	40.00
	Shank type:	VDI
	Tool adaption:	Weldon (DIN 1835 b) 12
	Gear ratio [i]:	1,5:1
	Torque max [Nm]:	16
	Rotation max [1/min]:	2666
	Rotating direction:	opposite
	Coolant:	EXT
	Please note:	Special version
8 030 46 045	Radial drilling and milling head ER 32	
	Weight [kg]:	6.660
	Version:	left
	Tool drive:	Coupling
	Shank size [mm]:	40.00
	Shank type:	VDI
	Tool adaption:	ER 32
	Gear ratio [i]:	1:2
	Torque max [Nm]:	16
	Rotation max [1/min]:	12000
	Rotating direction:	opposite
	Coolant:	EXT
	Please note:	stronger bearing
	Center distance [mm]:	69
8 030 46 048	Radial drilling and milling head ER 32 AX UT	
	Weight [kg]:	5.610
	Version:	left
	Tool drive:	Coupling
	Shank size [mm]:	40.00
	Shank type:	VDI
	Tool adaption:	ER 32 A - u-tec
	Gear ratio [i]:	1:1
	Torque max [Nm]:	50
	Rotation max [1/min]:	6000
	Rotating direction:	same
	Coolant:	EXT
	Center distance [mm]:	69

Part-#	Name	
8 030 46 077	Radial drilling and milling head ER 32	
	Weight [kg]:	5.720
	Version:	left
	Tool drive:	Coupling
	Shank size [mm]:	40.00
	Shank type:	VDI
	Tool adaption:	ER 32
	Gear ratio [i]:	1:1
	Torque max [Nm]:	50
	Rotation max [1/min]:	5000
	Rotating direction:	same
	Coolant:	EXT
	Center distance [mm]:	69
8 030 46 260	Radial drilling and milling head ER 32 AX UT	
	Version:	left
	Tool drive:	Coupling
	Shank size [mm]:	40.00
	Shank type:	VDI
	Tool adaption:	ER 32 A - u-tec
	Gear ratio [i]:	1:2
	Torque max [Nm]:	16
	Rotation max [1/min]:	12000
	Rotating direction:	opposite
	Coolant:	EXT
	Please note:	stronger bearing
	Center distance [mm]:	69
8 030 46 280	Radial drilling and milling head ER 32 AX UT IC	
	Weight [kg]:	6.140
	Version:	left
	Tool drive:	Coupling
	Shank size [mm]:	40.00
	Shank type:	VDI
	Tool adaption:	ER 32 A - u-tec
	Gear ratio [i]:	1:1
	Torque max [Nm]:	50
	Rotation max [1/min]:	6000
	Rotating direction:	same
	Coolant:	IC/Ext
	Pressure max [bar]:	140
	Center distance [mm]:	69
8 030 47 066	Radial drilling and milling head ER 40	
	Weight [kg]:	5.660
	Version:	left
	Tool drive:	Coupling
	Shank size [mm]:	40.00
	Shank type:	VDI
	Tool adaption:	ER 40
	Gear ratio [i]:	2:1
	Torque max [Nm]:	63
	Rotation max [1/min]:	3000
	Rotating direction:	opposite
	Coolant:	EXT
	Center distance [mm]:	69

Part-#	Name	
8 030 47 125	Radial drilling and milling head ER 40 IC	
	Weight [kg]:	6.230
	Version:	left
	Tool drive:	Coupling
	Shank size [mm]:	40.00
	Shank type:	VDI
	Tool adaption:	ER 40
	Gear ratio [i]:	2:1
	Torque max [Nm]:	63
	Rotation max [1/min]:	3000
	Rotating direction:	opposite
	Coolant:	IC/Ext
	Pressure max [bar]:	25
	Center distance [mm]:	69
8 033 45 015	Radial drilling and milling head ER 25 IC	
	Weight [kg]:	8.340
	Version:	left
	Tool drive:	Coupling
	Shank size [mm]:	40.00
	Shank type:	VDI
	Tool adaption:	ER 25
	Gear ratio [i]:	1:2
	Torque max [Nm]:	25
	Rotation max [1/min]:	8000
	Rotating direction:	same
	Coolant:	IC/Ext
8 033 46 024	Radial drilling and milling head ER 32 IC	
	Notation:	offset
	Version:	left
	Tool drive:	Coupling
	Shank size [mm]:	40.00
	Shank type:	VDI
	Tool adaption:	ER 32
	Gear ratio [i]:	1:1
	Torque max [Nm]:	50
	Rotation max [1/min]:	6000
	Rotating direction:	same
	Coolant:	IC/Ext
	Pressure max [bar]:	140
	Center distance [mm]:	100
8 033 46 028	Radial drilling and milling head ER 32	
	Weight [kg]:	7.700
	Notation:	offset
	Version:	left
	Tool drive:	Coupling
	Shank size [mm]:	40.00
	Shank type:	VDI
	Tool adaption:	ER 32
	Gear ratio [i]:	1:1
	Torque max [Nm]:	50
	Rotation max [1/min]:	6000
	Rotating direction:	same
	Coolant:	EXT
	Please note:	without reverse rotation
	Center distance [mm]:	100

Part-#	Name	
8 033 46 032	Radial drilling and milling head ER 32 IC	
	Weight [kg]:	8.620
	Notation:	offset
	Version:	left
	Tool drive:	Coupling
	Shank size [mm]:	40.00
	Shank type:	VDI
	Tool adaption:	ER 32
	Gear ratio [i]:	2:1
	Torque max [Nm]:	63
	Rotation max [1/min]:	3000
	Rotating direction:	same
	Coolant:	IC/Ext
	Center distance [mm]:	100
8 033 46 098	Radial drilling and milling head ER 32 AX UT IC	
	Weight [kg]:	8.080
	Notation:	offset
	Version:	left
	Tool drive:	Coupling
	Shank size [mm]:	40.00
	Shank type:	VDI
	Tool adaption:	ER 32 A - u-tec
	Gear ratio [i]:	1:1
	Torque max [Nm]:	50
	Rotation max [1/min]:	6000
	Rotating direction:	same
	Coolant:	IC/Ext
	Pressure max [bar]:	140
	Center distance [mm]:	100
8 033 46 116	Radial drilling and milling head ER 32 AX UT	
	Weight [kg]:	7.530
	Notation:	offset
	Version:	left
	Tool drive:	Coupling
	Shank size [mm]:	40.00
	Shank type:	VDI
	Tool adaption:	ER 32 A - u-tec
	Gear ratio [i]:	1:1
	Torque max [Nm]:	50
	Rotation max [1/min]:	6000
	Rotating direction:	same
	Coolant:	EXT
	Please note:	without reverse rotation
	Center distance [mm]:	100
8 033 47 021	Radial drilling and milling head HT 5 IC	
	Weight [kg]:	8.620
	Notation:	offset
	Version:	left
	Tool drive:	Coupling
	Shank size [mm]:	40.00
	Shank type:	VDI
	Tool adaption:	HT 5
	Gear ratio [i]:	2:1
	Torque max [Nm]:	63
	Rotation max [1/min]:	3000

Part-#	Name	
	Rotating direction:	same
	Coolant:	IC/Ext
	Center distance [mm]:	100
8 037 49 021	Radial disk mill head shaft diameter 16-32	
	Weight [kg]:	14.650
	Version:	left
	Tool drive:	Coupling
	Shank size [mm]:	40.00
	Shank type:	VDI
	Tool adaption:	Interchangeable arbor
	Gear ratio [i]:	3:1
	Torque max [Nm]:	80
	Rotation max [1/min]:	2000
	Rotating direction:	opposite
	Coolant:	EXT
	Please note:	Price without arbor, strong version
	Center distance [mm]:	113
8 040 44 037	Universal head ± 90° adjustable ER 16 AX UT	
	Tool drive:	Coupling
	Shank size [mm]:	40.00
	Shank type:	VDI
	Tool adaption:	ER 16 A - u-tec
	Gear ratio [i]:	1:2
	Torque max [Nm]:	12
	Rotation max [1/min]:	12000
	Rotating direction:	opposite
	Coolant:	EXT
	Center distance [mm]:	87
8 040 44 063	Universal head ± 90° adjustable ER 16 AX UT	
	Tool drive:	Coupling
	Shank size [mm]:	40.00
	Shank type:	VDI
	Tool adaption:	ER 16 A - u-tec
	Gear ratio [i]:	1:1
	Torque max [Nm]:	25
	Rotation max [1/min]:	6000
	Rotating direction:	opposite
	Coolant:	EXT
	Center distance [mm]:	87
8 040 44 083	Universal head ± 90° adjustable ER 16 AX UT IC	
	Tool drive:	Coupling
	Shank size [mm]:	40.00
	Shank type:	VDI
	Tool adaption:	ER 16 A - u-tec
	Gear ratio [i]:	1:1
	Torque max [Nm]:	25
	Rotation max [1/min]:	6000
	Rotating direction:	opposite
	Coolant:	IC/Ext
	Pressure max [bar]:	140
	Center distance [mm]:	87

Part-#	Name	
8 040 44 087	Universal head ± 90° adjustable ER 16 AX UT IC	
	Tool drive:	Coupling
	Shank size [mm]:	40.00
	Shank type:	VDI
	Tool adaption:	ER 16 A - u-tec
	Gear ratio [i]:	1:2
	Torque max [Nm]:	12
	Rotation max [1/min]:	12000
	Rotating direction:	opposite
	Coolant:	IC/Ext
	Pressure max [bar]:	140
	Center distance [mm]:	87
8 040 45 062	Universal head ± 90° adjustable ER 25 AX UT	
	Weight [kg]:	5.400
	Tool drive:	Coupling
	Shank size [mm]:	40.00
	Shank type:	VDI
	Tool adaption:	ER 25 A - u-tec
	Gear ratio [i]:	1:1
	Torque max [Nm]:	25
	Rotation max [1/min]:	6000
	Rotating direction:	opposite
	Coolant:	EXT
	Please note:	stronger bearing
	Center distance [mm]:	87
8 040 45 149	Universal head ± 95° adjustable ER 25 AX UT IC	
	Weight [kg]:	5.390
	Tool drive:	Coupling
	Shank size [mm]:	40.00
	Shank type:	VDI
	Tool adaption:	ER 25 A - u-tec
	Gear ratio [i]:	1:1
	Torque max [Nm]:	25
	Rotation max [1/min]:	6000
	Rotating direction:	opposite
	Coolant:	IC/Ext
	Pressure max [bar]:	140
	Please note:	stronger bearing
	Center distance [mm]:	87
8 200 40 000	Plug Z2-40 K	
	Weight [kg]:	0.140
	Shank size [mm]:	40.00
	Shank type:	VDI
8 200 40 001	Plug Z2-40 S	
	Weight [kg]:	1.360
	Shank size [mm]:	40.00
	Shank type:	VDI
8 202 43 000	Basic holder transversal set SZ 40	
	Weight [kg]:	1.560
	Shank size [mm]:	40.00
	Shank type:	VDI
	Tool adaption:	Interface SZ 40
	Coolant:	EXT



Part-#	Name	
8 206 42 000	Adapter for VDI 30	
	Weight [kg]:	3.530
	Version:	doubletoothed
	Shank size [mm]:	40.00
	Shank type:	VDI
	Tool adaption:	DIN 69880 - 30
	Coolant:	EXT
	Please note:	Special
8 208 49 001	Test mandrel VDI 40x40x200	
	Weight [kg]:	3.020
	Shank size [mm]:	40.00
	Shank type:	VDI
8 208 49 003	Test mandrel VDI 40x40x300	
	Weight [kg]:	4.020
	Shank size [mm]:	40.00
	Shank type:	VDI
8 210 41 000	Tool holder F 40-MK 1	
	Weight [kg]:	1.600
	Shank size [mm]:	40.00
	Shank type:	VDI
	Tool adaption:	DIN 228 D - MK 1
	Coolant:	IC
8 210 42 001	Tool holder F 40-MK 2	
	Weight [kg]:	1.620
	Shank size [mm]:	40.00
	Shank type:	VDI
	Tool adaption:	DIN 228 D - MK 2
	Coolant:	IC
8 210 43 000	Tool holder E2-40x 8	
	Shank size [mm]:	40.00
	Shank type:	VDI
	Tool adaption:	Ø 8
	Coolant:	IC/Ext
8 210 43 002	Tool holder F 40-MK 3	
	Weight [kg]:	1.520
	Shank size [mm]:	40.00
	Shank type:	VDI
	Tool adaption:	DIN 228 D - MK 3
	Coolant:	IC
8 210 43 003	Short drill chuck VDI 40x 8	
	Weight [kg]:	1.700
	Shank size [mm]:	40.00
	Shank type:	VDI
	Coolant:	EXT
8 210 43 004	Short drill chuck VDI 40x 8 - IC	
	Weight [kg]:	1.730
	Shank size [mm]:	40.00
	Shank type:	VDI
	Coolant:	IC



Part-#	Name	
8 210 44 001	Tool holder E2-40x10	
	Weight [kg]:	2.320
	Shank size [mm]:	40.00
	Shank type:	VDI
	Tool adaption:	Ø 10
	Coolant:	IC/Ext
8 210 44 007	Tool holder F 40-MK 4	
	Weight [kg]:	2.460
	Shank size [mm]:	40.00
	Shank type:	VDI
	Tool adaption:	DIN 228 D - MK 4
	Coolant:	IC
8 210 44 008	Short drill chuck VDI 40x13	
	Weight [kg]:	2.280
	Shank size [mm]:	40.00
	Shank type:	VDI
	Coolant:	EXT
8 210 44 010	Tool holder E1-40x10	
	Shank size [mm]:	40.00
	Shank type:	VDI
	Tool adaption:	Ø 10
	Coolant:	IC
8 210 44 011	Tool holder E1-40x12	
	Shank size [mm]:	40.00
	Shank type:	VDI
	Tool adaption:	Ø 12
	Coolant:	IC
8 210 44 014	Short drill chuck VDI 40x13 - IC	
	Weight [kg]:	2.290
	Shank size [mm]:	40.00
	Shank type:	VDI
	Coolant:	IC
8 210 44 019	Tool holder E2-40x10 - special	
	Shank size [mm]:	40.00
	Shank type:	VDI
	Tool adaption:	Ø 10
	Coolant:	IC/Ext
	Please note:	Shaft with hole, locked with screw
8 210 44 020	Tool holder E2-40x12 - special	
	Shank size [mm]:	40.00
	Shank type:	VDI
	Tool adaption:	Ø 12
	Coolant:	IC/Ext
	Please note:	Shaft with hole, locked with screw
8 210 45 000	Tool holder E2-40x16	
	Shank size [mm]:	40.00
	Shank type:	VDI
	Tool adaption:	Ø 16
	Coolant:	IC/Ext

Part-#	Name	
	8 210 45 002 Tool holder E4-40xER 25	
	Weight [kg]:	1.570
	Shank size [mm]:	40.00
	Shank type:	VDI
	Tool adaption:	ER 25
	Coolant:	IC
	8 210 45 003 Tool holder E1-40x16	
	Shank size [mm]:	40.00
	Shank type:	VDI
	Tool adaption:	Ø 16
	Coolant:	IC
	8 210 45 006 Short drill chuck VDI 40x16	
	Weight [kg]:	2.460
	Shank size [mm]:	40.00
	Shank type:	VDI
	Coolant:	EXT
	8 210 45 009 Short drill chuck VDI 40x16 - IC	
	Weight [kg]:	2.320
	Shank size [mm]:	40.00
	Shank type:	VDI
	Coolant:	IC
	8 210 45 020 Tool holder ER 25 AX UT IC	
	Weight [kg]:	1.860
	Shank size [mm]:	40.00
	Shank type:	VDI
	Tool adaption:	ER 25 A - u-tec
	Coolant:	IC/Ext
	8 210 46 000 Tool holder E4-40xER 32	
	Weight [kg]:	1.640
	Shank size [mm]:	40.00
	Shank type:	VDI
	Tool adaption:	ER 32
	Coolant:	IC
	8 210 46 002 Tool holder E2-40x20	
	Shank size [mm]:	40.00
	Shank type:	VDI
	Tool adaption:	Ø 20
	Coolant:	IC/Ext
	8 210 46 004 Tool holder E1-40x20	
	Shank size [mm]:	40.00
	Shank type:	VDI
	Tool adaption:	Ø 20
	Coolant:	IC

Part-#	Name	
8 210 46 010	Tool holder E2-40x20 - special	
	Shank size [mm]:	40.00
	Shank type:	VDI
	Tool adaption:	Ø 20
	Coolant:	IC/Ext
	Please note:	Shaft with hole, locked with screw
8 210 47 001	Tool holder E2-40x25	
	Shank size [mm]:	40.00
	Shank type:	VDI
	Tool adaption:	Ø 25
	Coolant:	IC/Ext
8 210 47 004	Tool holder E4-40xER 40	
	Shank size [mm]:	40.00
	Shank type:	VDI
	Tool adaption:	ER 40
	Coolant:	IC
8 210 47 005	Tool holder E1-40x25	
	Weight [kg]:	1.840
	Shank size [mm]:	40.00
	Shank type:	VDI
	Tool adaption:	Ø 25
	Coolant:	IC
8 210 47 010	Tool holder HT 5 IC	
	Version:	right / left
	Shank size [mm]:	40.00
	Shank type:	VDI
	Tool adaption:	HT 5
	Coolant:	IC/Ext
	Please note:	HT- insert 3x 90° demountable
8 210 47 012	Tool holder HT 5 IC	
	Weight [kg]:	1.880
	Version:	left
	Shank size [mm]:	40.00
	Shank type:	VDI
	Tool adaption:	HT 5
	Coolant:	IC/Ext
8 210 48 001	Tool holder E2-40x32	
	Shank size [mm]:	40.00
	Shank type:	VDI
	Tool adaption:	Ø 32
	Coolant:	IC/Ext
8 210 48 004	Tool holder E1-40x32	
	Weight [kg]:	1.830
	Shank size [mm]:	40.00
	Shank type:	VDI
	Tool adaption:	Ø 32
	Coolant:	IC

Part-#	Name	
8 210 48 012	Tool holder E2-40x32 special	
	Version:	Special
	Shank size [mm]:	40.00
	Shank type:	VDI
	Tool adaption:	Ø 32
	Coolant:	IC/Ext
	Please note:	with end stop
8 210 49 000	Tool holder E2-40x40	
	Shank size [mm]:	40.00
	Shank type:	VDI
	Tool adaption:	Ø 40
	Coolant:	IC/Ext
8 210 49 002	Tool holder E1-40x40	
	Shank size [mm]:	40.00
	Shank type:	VDI
	Tool adaption:	Ø 40
	Coolant:	IC
8 210 49 003	Tool holder E1-40x50	
	Shank size [mm]:	40.00
	Shank type:	VDI
	Tool adaption:	Ø 50
	Coolant:	IC
8 210 49 005	Tool holder E2-40x50	
	Weight [kg]:	3.000
	Shank size [mm]:	40.00
	Shank type:	VDI
	Tool adaption:	Ø 50
	Coolant:	IC/Ext
8 215 43 000	Tool holder C2-40x25	
	Employment for:	VDI 40
	Version:	left
	Shank size [mm]:	40.00
	Shank type:	VDI
	Tool adaption:	Sq. 25/20
	Coolant:	EXT
8 215 43 001	Tool holder C4-40x25	
	Employment for:	VDI 40
	Version:	left
	Shank type:	VDI
	Tool adaption:	Sq. 25/20
	Coolant:	EXT
8 215 43 003	Tool holder C2-40x25 special	
	Weight [kg]:	4.480
	Version:	left
	Shank size [mm]:	40.00
	Shank type:	VDI
	Tool adaption:	Sq. 25/20
	Coolant:	EXT

Part-#	Name	
8 219 47 004	Boring bar holder ø 25	
	Weight [kg]:	2.820
	Version:	left; offset
	Shank size [mm]:	40.00
	Shank type:	VDI
	Tool adaption:	Ø 25
	Coolant:	IC/Ext
	Offset [mm]:	25
8 219 48 006	Boring bar holder ø 32	
	Version:	left, offset
	Shank size [mm]:	40.00
	Shank type:	VDI
	Tool adaption:	Ø 32
	Coolant:	IC/Ext
	Offset [mm]:	30
8 235 43 000	Tool holder B2-40x25x44	
	Employment for:	VDI 40
	Version:	left
	Shank size [mm]:	40.00
	Shank type:	VDI
	Tool adaption:	Sq. 25/20
	Coolant:	EXT
8 235 43 001	Tool holder B4-40x25x44	
	Employment for:	VDI 40
	Version:	left
	Shank size [mm]:	40.00
	Shank type:	VDI
	Tool adaption:	Sq. 25/20
	Coolant:	EXT
8 235 43 009	Tool holder B6-40x25x44 special	
	Weight [kg]:	2.960
	Employment for:	VDI 40
	Version:	Special; left
	Shank size [mm]:	40.00
	Shank type:	VDI
	Tool adaption:	Sq. 25/20
	Coolant:	EXT
	Please note:	Insert for system "Jetstream" from Seco
8 235 43 010	Tool holder B2-40x25x44 special	
	Weight [kg]:	2.260
	Employment for:	VDI 40
	Version:	Special; left
	Shank size [mm]:	40.00
	Shank type:	VDI
	Tool adaption:	Sq. 25/20
	Coolant:	EXT
	Please note:	Insert for system "Jetstream" from Seco
8 262 49 000	Stock stop VDI 40 - Ø 42	
	Weight [kg]:	1.360
	Shank size [mm]:	40.00
	Shank type:	VDI

Part-#	Name	
8 262 49 001	Stock stop VDI 40 - Ø 60	
	Weight [kg]:	1.620
	Shank size [mm]:	40.00
	Shank type:	VDI
8 262 49 002	Stock stop VDI 40 - Ø 54	
	Weight [kg]:	1.530
	Shank size [mm]:	40.00
	Shank type:	VDI
8 267 49 002	Bar pick-up VDI 40 offset left	
	Weight [kg]:	2.080
	Version:	left
	Shank size [mm]:	40.00
	Shank type:	VDI
	Please note:	Chuck jaws 62-85 mm special accessories
8 320 42 018	Cut-off holder, height adjustable SH 26 IC	
	Version:	universal
	Shank size [mm]:	40.00
	Shank type:	VDI
	Tool adaption:	Clampshaft SH 26
	Coolant:	IC/Ext
	Pressure max [bar]:	70
8 320 43 009	Cut-off holder, height adjustable SH 32 IC	
	Weight [kg]:	2.480
	Version:	universal
	Shank size [mm]:	40.00
	Shank type:	VDI
	Tool adaption:	Clampshaft SH 32
	Coolant:	IC/Ext
	Pressure max [bar]:	70
8 320 49 005	Cut-off holder, height adjustable 845 IC	
	Weight [kg]:	2.700
	Version:	universal
	Shank size [mm]:	40.00
	Shank type:	VDI
	Tool adaption:	 System 845
	Coolant:	IC
	Pressure max [bar]:	70

heimatec.u-tec®

heimatec.com

Products / Tool change systems /
u-tec® Tool-changing system



versions see catalog

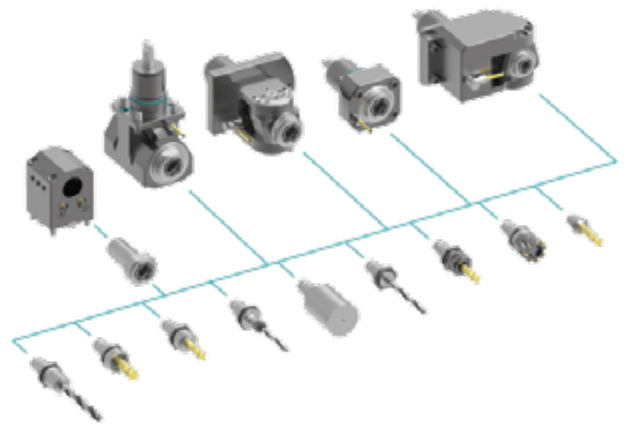

heimatec.easy-quick

heimatec.com

Products / Tool change systems /
easy-quick HT quick-changing system



versions see catalog

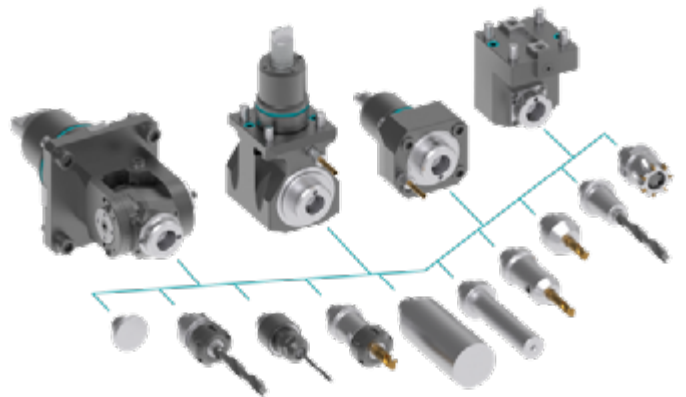

heimatec.Capto™

heimatec.com

Products / Tool change systems /
heimatec.Capto™ quick-changing system



versions see catalog

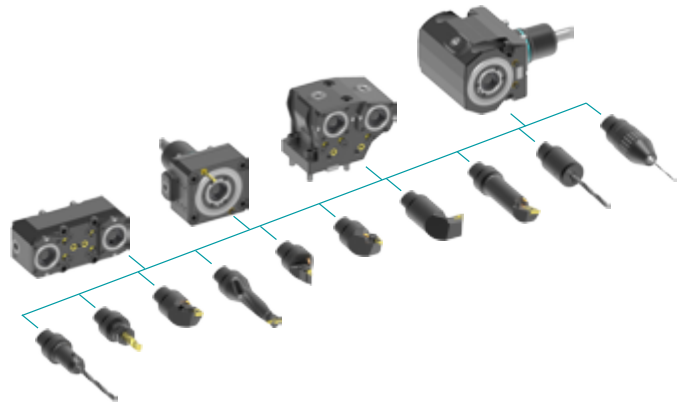

heimatec.accessories

heimatec.com

Products / Accessories



versions see catalog





● heimatec overseas branches

○ global representations of heimatec

heimatec[®]

heimatec GmbH
Präzisionswerkzeuge
Carl-Benz-Str. 4
77871 Renchen
Germany

T +49 7843 9466 0
www.heimatec.com
info@heimatec.com

Please find the contact details of our worldwide trading partners on our website:
<https://heimatec.com/business-partners>