

Mori Seiki

**NTX 2000 - BMT  
40**



# High-tech from heimatec - heimatec - Tools and systems for productive turning and milling

heimatec belongs to the international technology and quality leaders for precision tools and specializes in the development and production of high-precision static and live tools for all CNC lathes, CNC turn-/mill machines and CNC machining centers.

The range of products\* spans from static BMT and VDI tool holders, live tools up to highly complex customer-specific individual solutions. heimatec, headquartered in Renchen, has a own subsidiary in Asia and India and numerous representatives as well as trading partners all over the world.

## \*OUR PRODCUTS

Static tool holders

Live tool units

Precision tools

Tools for turning and machining centres

Tools for swiss type lathes

Tool changing and uick-change systems

Tool systems for gear production



Digital tool management



This catalogue, including all its parts, is protected by copyright. Any use outside the restricted limitations of the Copyright Act without the consent of heimatec is inadmissible and liable to prosecution. This applies in particular to duplication, translation, microfilming and storage and processing in electronic systems.

**heimatec GmbH** reserves the right to make technical changes at any time without giving prior notice. This applies in particular to adjustments at any time to meet new or changed international standards, or in case of further developments of our products or manufacturing processes.

The current version of our General Terms and Conditions can be found on our website.

Part-#	Name	
<b>8 010 45 177</b>	<b>Axial drilling and milling head ER 25 AS UT IC</b>	
	Weight [kg]:	3.540
	Tool drive:	Flat (~DIN 1809)
	Shank size [mm]:	40.00
	Shank type:	BMT
	Tool adaption:	ER 25 A - u-tec
	Gear ratio [i]:	1:1
	Torque max [Nm]:	50
	Rotation max [1/min]:	6000
	Rotating direction:	same
	Coolant:	IC/Ext
	Pressure max [bar]:	25
<b>8 010 45 190</b>	<b>Axial drilling and milling head ER 25 AS UT IC</b>	
	Tool drive:	Flat (~DIN 1809)
	Shank size [mm]:	40.00
	Shank type:	BMT
	Tool adaption:	ER 25 A - u-tec
	Gear ratio [i]:	1:1
	Torque max [Nm]:	50
	Rotation max [1/min]:	10000
	Rotating direction:	same
	Coolant:	IC/Ext
	Pressure max [bar]:	80
	Please note:	Dryrun possible
<b>8 010 46 158</b>	<b>Axial drilling and milling head ER 32 AX UT IC</b>	
	Weight [kg]:	4.230
	Tool drive:	Flat (~DIN 1809)
	Shank size [mm]:	40.00
	Shank type:	BMT
	Tool adaption:	ER 32 A - u-tec
	Gear ratio [i]:	1:1
	Torque max [Nm]:	50
	Rotation max [1/min]:	6000
	Rotating direction:	same
	Coolant:	IC/Ext
	Pressure max [bar]:	70
	Please note:	stronger bearing
<b>8 010 46 254</b>	<b>Axial drilling and milling head ER 32 AX UT IC</b>	
	Weight [kg]:	4.230
	Tool drive:	Flat (~DIN 1809)
	Shank size [mm]:	40.00
	Shank type:	BMT
	Tool adaption:	ER 32 A - u-tec
	Gear ratio [i]:	1:1
	Torque max [Nm]:	50
	Rotation max [1/min]:	6000
	Rotating direction:	same
	Coolant:	IC/Ext
	Pressure max [bar]:	25
	Please note:	stronger bearing

Part-#	Name		
	<b>8 010 46 279</b>	<b>Axial drilling and milling head C 4</b>	
		Weight [kg]:	4.120
		Notation:	180° reversible
		Tool drive:	Flat (~DIN 1809)
		Shank size [mm]:	40.00
		Shank type:	BMT
		Tool adaption:	heimatec Capto(TM) C 4
		Gear ratio [i]:	1:1
		Torque max [Nm]:	50
		Rotation max [1/min]:	8000
		Rotating direction:	same
		Coolant:	EXT
	Please note:	Check applicability; tool length check!	
	<b>8 010 46 295</b>	<b>Axial drilling and milling head ER 32 AS UT</b>	
		Weight [kg]:	2.820
		Tool drive:	Flat (~DIN 1809)
		Shank size [mm]:	40.00
		Shank type:	BMT
		Tool adaption:	ER 32 A - u-tec
		Gear ratio [i]:	1:1
		Torque max [Nm]:	50
		Rotation max [1/min]:	12000
		Rotating direction:	same
	Coolant:	EXT	
	<b>8 010 46 296</b>	<b>Axial drilling and milling head ER 32 AS UT IC</b>	
		Weight [kg]:	3.690
		Tool drive:	Flat (~DIN 1809)
		Shank size [mm]:	40.00
		Shank type:	BMT
		Tool adaption:	ER 32 A - u-tec
		Gear ratio [i]:	1:1
		Torque max [Nm]:	50
		Rotation max [1/min]:	6000
		Rotating direction:	same
	Coolant:	IC/Ext	
	Pressure max [bar]:	25	
	<b>8 010 46 300</b>	<b>Axial drilling and milling head HT 4 IC</b>	
		Tool drive:	Flat (~DIN 1809)
		Shank size [mm]:	40.00
		Shank type:	BMT
		Tool adaption:	HT 4
		Gear ratio [i]:	1:1
		Torque max [Nm]:	50
		Rotation max [1/min]:	12000
		Rotating direction:	same
		Coolant:	IC/Ext
	Pressure max [bar]:	100	
	Please note:	Dryrun possible	

Part-#	Name	
<b>8 010 46 306</b>	<b>Axial drilling and milling head ER 32 AS UT IC</b>	
	Weight [kg]:	3.980
	Tool drive:	Flat (~DIN 1809)
	Shank size [mm]:	40.00
	Shank type:	BMT
	Tool adaption:	ER 32 A - u-tec
	Gear ratio [i]:	1:1
	Torque max [Nm]:	50
	Rotation max [1/min]:	10000
	Rotating direction:	same
	Coolant:	IC/Ext
	Pressure max [bar]:	80
	Please note:	Dryrun possible
<b>8 013 43 000</b>	<b>Axial drilling and milling head ER 11</b>	
	Weight [kg]:	0.740
	Tool drive:	Flat (~DIN 1809)
	Shank size [mm]:	40.00
	Shank type:	BMT
	Tool adaption:	ER 11
	Gear ratio [i]:	1:4
	Torque max [Nm]:	5
	Rotation max [1/min]:	48000
	Rotating direction:	same
	Coolant:	EXT
<b>8 013 44 009</b>	<b>Axial drilling and milling head ER 16 AX UT</b>	
	Weight [kg]:	2.410
	Tool drive:	Flat (~DIN 1809)
	Shank size [mm]:	40.00
	Shank type:	BMT
	Tool adaption:	ER 16 A - u-tec
	Gear ratio [i]:	1:4
	Torque max [Nm]:	5
	Rotation max [1/min]:	24000
	Rotating direction:	same
	Coolant:	EXT
<b>8 013 44 010</b>	<b>Axial drilling and milling head ER 16 AX UT IC</b>	
	Tool drive:	Flat (~DIN 1809)
	Shank size [mm]:	40.00
	Shank type:	BMT
	Tool adaption:	ER 16 A - u-tec
	Gear ratio [i]:	1:4
	Torque max [Nm]:	5
	Rotation max [1/min]:	24000
	Rotating direction:	same
	Coolant:	IC/Ext
	Pressure max [bar]:	80
<b>8 019 45 178</b>	<b>Axial drilling and milling head ER 25 AX UT</b>	
	Weight [kg]:	7.330
	Notation:	offset
	Employment for:	Main spindle
	Version:	Special
	Tool drive:	Flat (~DIN 1809)
	Shank size [mm]:	40.00

Part-#	Name
--------	------

Shank type: BMT  
 Tool adaption: ER 25 A - u-tec  
 Gear ratio [i]: 1:1  
 Torque max [Nm]: 40  
 Rotation max [1/min]: 12000  
 Rotating direction: opposite  
 Coolant: EXT  
 Please note: stronger bearing  
 Offset [mm]: 100

**8 019 46 217 Axial drilling and milling head C 4 IC**

Weight [kg]: 9.060  
 Notation: 180° reversible  
 Tool drive: Flat (~DIN 1809)  
 Shank size [mm]: 39.90  
 Shank type: BMT  
 Tool adaption: heimatec Capto(TM) C 4  
 Gear ratio [i]: 1:1  
 Torque max [Nm]: 50  
 Rotation max [1/min]: 8000  
 Rotating direction: opposite  
 Coolant: IC/Ext  
 Pressure max [bar]: 140  
 Please note: Check applicability; note tool length!  
 Offset [mm]: 110

**8 030 43 012 Radial drilling and milling head ER 11**

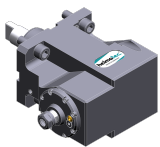

Weight [kg]: 6.790  
 Notation: 180° reversible  
 Tool drive: Flat (~DIN 1809)  
 Shank size [mm]: 40.00  
 Shank type: BMT  
 Tool adaption: ER 11  
 Gear ratio [i]: 1:4  
 Torque max [Nm]: 5  
 Rotation max [1/min]: 48000  
 Rotating direction: opposite  
 Coolant: EXT  
 Center distance [mm]: 85

**8 030 44 079 Radial drilling and milling head ER 16 AX UT**

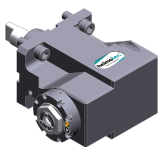



Weight [kg]: 6.860  
 Notation: 180° reversible  
 Tool drive: Flat (~DIN 1809)  
 Shank size [mm]: 40.00  
 Shank type: BMT  
 Tool adaption: ER 16 A - u-tec  
 Gear ratio [i]: 1:4  
 Torque max [Nm]: 5  
 Rotation max [1/min]: 24000  
 Rotating direction: opposite  
 Coolant: EXT  
 Center distance [mm]: 85

Part-#	Name
--------	------

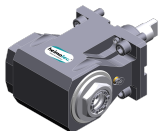
<b>8 030 45 139</b>	<b>Angle-mill- and drill holder ER 25 AS UT</b>	6.970
	Weight [kg]:	6.970
	Notation:	180° reversible
	Tool drive:	Flat (~DIN 1809)
	Shank size [mm]:	40.00
	Shank type:	BMT
	Tool adaption:	ER 25 A - u-tec
	Gear ratio [i]:	1:1
	Torque max [Nm]:	50
	Rotation max [1/min]:	6000
	Rotating direction:	opposite
	Coolant:	EXT
	Please note:	Combi bearing
	Center distance [mm]:	85
<b>8 030 45 195</b>	<b>Radial drilling and milling head ER 25 AX UT</b>	6.040
	Weight [kg]:	6.040
	Notation:	180° reversible
	Tool drive:	Flat (~DIN 1809)
	Shank size [mm]:	40.00
	Shank type:	BMT
	Tool adaption:	ER 25 A - u-tec
	Gear ratio [i]:	1:2
	Torque max [Nm]:	16
	Rotation max [1/min]:	12000
	Rotating direction:	same
	Coolant:	EXT
	Please note:	stronger bearing
	Center distance [mm]:	85
<b>8 030 45 202</b>	<b>Radial drilling and milling head ER 25 AS UT</b>	6.940
	Weight [kg]:	6.940
	Notation:	180° reversible
	Tool drive:	Flat (~DIN 1809)
	Shank size [mm]:	40.00
	Shank type:	BMT
	Tool adaption:	ER 25 A - u-tec
	Gear ratio [i]:	1:1
	Torque max [Nm]:	50
	Rotation max [1/min]:	12000
	Rotating direction:	opposite
	Coolant:	EXT
	Center distance [mm]:	85
<b>8 030 45 573</b>	<b>Radial drilling and milling head ER 25 AS UT IC</b>	7.640
	Weight [kg]:	7.640
	Notation:	180° reversible
	Tool drive:	Flat (~DIN 1809)
	Shank size [mm]:	40.00
	Shank type:	BMT
	Tool adaption:	ER 25 A - u-tec
	Gear ratio [i]:	1:1
	Torque max [Nm]:	50
	Rotation max [1/min]:	12000
	Rotating direction:	opposite
	Coolant:	IC/Ext
	Pressure max [bar]:	140
	Center distance [mm]:	85



Part-#	Name	
<b>8 030 45 588</b>	<b>Radial drilling and milling head ER 25 AS UT</b>	
	Weight [kg]:	6.527
	Notation:	180° reversible
	Tool drive:	Flat (~DIN 1809)
	Shank size [mm]:	40.00
	Shank type:	BMT
	Tool adaption:	ER 25 A - u-tec
	Gear ratio [i]:	1:1
	Torque max [Nm]:	50
	Rotation max [1/min]:	12000
	Rotating direction:	opposite
	Coolant:	EXT
	Center distance [mm]:	85
<b>8 030 46 320</b>	<b>Angle-mill- and drill holder ER 32 AS UT IC</b>	
	Weight [kg]:	7.000
	Notation:	180° reversible
	Tool drive:	Flat (~DIN 1809)
	Shank size [mm]:	40.00
	Shank type:	BMT
	Tool adaption:	ER 32 A - u-tec
	Gear ratio [i]:	1:1
	Torque max [Nm]:	50
	Rotation max [1/min]:	6000
	Rotating direction:	opposite
	Coolant:	IC/Ext
	Pressure max [bar]:	140
	Please note:	Combi bearing
	Center distance [mm]:	85
<b>8 031 45 058</b>	<b>Radial milling head universal arbor 1"</b>	
	Weight [kg]:	7.040
	Notation:	180° reversible
	Tool drive:	Flat (~DIN 1809)
	Shank size [mm]:	40.00
	Shank type:	BMT
	Tool adaption:	Universal arbor 1" (25,4mm)
	Gear ratio [i]:	1:1
	Torque max [Nm]:	50
	Rotation max [1/min]:	8000
	Rotating direction:	opposite
	Coolant:	EXT
	Please note:	Combi bearing
	Center distance [mm]:	85
<b>8 039 45 094</b>	<b>Radial drilling and milling head ER 25 AS UT</b>	
	Weight [kg]:	6.500
	Notation:	180° reversible
	Version:	double spindle
	Tool drive:	Flat (~DIN 1809)
	Shank size [mm]:	40.00
	Shank type:	BMT
	Tool adaption:	ER 25 A - u-tec
	Gear ratio [i]:	1:1
	Torque max [Nm]:	50
	Rotation max [1/min]:	12000
	Rotating direction:	same/opposite

Part-#	Name	
	Coolant:	EXT
	Please note:	stronger bearing
	Center distance [mm]:	85
<b>8 043 44 009</b>	<b>Universal head +105°/-20° adj. ER16 AX UT</b>	
	Weight [kg]:	5.450
	Notation:	offset; 180° reversible
	Tool drive:	Flat (~DIN 1809)
	Shank size [mm]:	40.00
	Shank type:	BMT
	Tool adaption:	ER 16 A - u-tec
	Gear ratio [i]:	1:1
	Torque max [Nm]:	25
	Rotation max [1/min]:	6000
	Rotating direction:	opposite
	Coolant:	EXT
	Center distance [mm]:	55
	Offset [mm]:	35
<b>8 043 45 009</b>	<b>Universal head +105°/-20° adj. ER25 AX UT</b>	
	Weight [kg]:	5.650
	Notation:	offset; 180° reversible
	Tool drive:	Flat (~DIN 1809)
	Shank size [mm]:	40.00
	Shank type:	BMT
	Tool adaption:	ER 25 A - u-tec
	Gear ratio [i]:	1:1
	Torque max [Nm]:	25
	Rotation max [1/min]:	6000
	Rotating direction:	opposite
	Coolant:	EXT
	Please note:	stronger bearing
	Center distance [mm]:	55
	Offset [mm]:	35
<b>8 043 45 012</b>	<b>Universal head +105°/-20° adj. ER25 AXUTIK</b>	
	Weight [kg]:	5.660
	Notation:	offset; 180° reversible
	Tool drive:	Flat (~DIN 1809)
	Shank size [mm]:	40.00
	Shank type:	BMT
	Tool adaption:	ER 25 A - u-tec
	Gear ratio [i]:	1:1
	Torque max [Nm]:	25
	Rotation max [1/min]:	6000
	Rotating direction:	opposite
	Coolant:	IC/Ext
	Pressure max [bar]:	25
	Please note:	stronger bearing
	Center distance [mm]:	55
	Offset [mm]:	35

Part-#	Name	
<b>8 224 04 029</b>	<b>Universal turning holder sq. 20</b>	
	Weight [kg]:	4.040
	Notation:	180° reversible
	Shank size [mm]:	40.00
	Shank type:	BMT
	Machine adaption:	Centering key slot b 12
	Tool adaption:	Sq. 20
	Coolant:	EXT
	Pressure max [bar]:	80
<b>8 224 04 044</b>	<b>Universal turning holder sq. 20</b>	
	Notation:	180° reversible
	Shank size [mm]:	40.00
	Shank type:	BMT
	Machine adaption:	Centering key slot b 12
	Tool adaption:	Sq. 20
	Coolant:	EXT
	Pressure max [bar]:	80
<b>8 224 05 009</b>	<b>Universal turning holder sq. 25</b>	
	Weight [kg]:	4.360
	Notation:	180° reversible
	Shank size [mm]:	40.00
	Shank type:	BMT
	Machine adaption:	Centering key slot b 12
	Tool adaption:	Sq. 25
	Coolant:	EXT
	Pressure max [bar]:	80
<b>8 240 06 023</b>	<b>Collet chuck holder ER 32</b>	
	Notation:	180° reversible
	Shank size [mm]:	40.00
	Shank type:	BMT
	Machine adaption:	Centering key slot b 12
	Tool adaption:	ER 32
	Coolant:	IC/Ext
	Pressure max [bar]:	80
	Center distance [mm]:	90
<b>8 240 07 063</b>	<b>Boring bar holder Ø 1 1/4"</b>	
	Weight [kg]:	6.180
	Shank size [mm]:	40.00
	Shank type:	BMT
	Machine adaption:	Centering key slot b 12
	Tool adaption:	Ø 1 1/4" (31,75mm)
	Coolant:	IC/Ext
	Pressure max [bar]:	80
	Center distance [mm]:	100
<b>8 240 08 030</b>	<b>Boring bar holder Ø 32</b>	
	Weight [kg]:	6.350
	Notation:	180° reversible
	Shank size [mm]:	40.00
	Shank type:	BMT
	Machine adaption:	Centering key slot b 12
	Tool adaption:	Ø 32
	Coolant:	IC/Ext

Part-#	Name	
	Pressure max [bar]:	80
	Center distance [mm]:	100
<b>8 240 09 020</b>	<b>Boring bar holder Ø 40</b>	
	Notation:	180° reversible
	Shank size [mm]:	40.00
	Shank type:	BMT
	Machine adaption:	Centering key slot b 12
	Tool adaption:	Ø 40
	Coolant:	IC/Ext
	Pressure max [bar]:	140
	Center distance [mm]:	100
<b>8 244 04 009</b>	<b>Combi facing holder sq. 20</b>	
	Weight [kg]:	4.380
	Notation:	180° reversible
	Shank size [mm]:	40.00
	Shank type:	BMT
	Machine adaption:	Centering key slot b 12
	Tool adaption:	Sq. 20
		Sq. 20
	Coolant:	EXT
	Pressure max [bar]:	80
	Center distance [mm]:	60
<b>8 244 05 007</b>	<b>Combi facing holder sq. 25</b>	
	Notation:	180° reversible
	Shank size [mm]:	40.00
	Shank type:	BMT
	Machine adaption:	Centering key slot b 12
	Tool adaption:	Sq. 25
		Sq. 25
	Coolant:	EXT
	Pressure max [bar]:	80
	Center distance [mm]:	60
<b>8 249 08 003</b>	<b>Double boring bar holder Ø 32</b>	
	Weight [kg]:	8.590
	Shank size [mm]:	40.00
	Shank type:	BMT
	Machine adaption:	Centering key slot b 12
	Tool adaption:	Ø 32
	Coolant:	IC/Ext
	Pressure max [bar]:	80
	Center distance [mm]:	100
<b>8 249 09 001</b>	<b>Double boring bar holder Ø 40</b>	
	Weight [kg]:	8.110
	Shank size [mm]:	40.00
	Shank type:	BMT
	Machine adaption:	Centering key slot b 12
	Tool adaption:	Ø 40
	Coolant:	IC/Ext
	Pressure max [bar]:	80
	Center distance [mm]:	100

Part-#	Name	
<b>8 251 03 005</b>	<b>Combi double turning holder sq. 3/4"</b>	
	Weight [kg]:	5.740
	Shank size [mm]:	40.00
	Shank type:	BMT
	Machine adaption:	Centering key slot b 12
	Tool adaption:	Sq. 3/4" (19,05mm)
		Sq. 3/4" (19,05mm)
		Sq. 3/4" (19,05mm)
		Sq. 3/4" (19,05mm)
	Coolant:	EXT
	Pressure max [bar]:	80
	Please note:	short version; 70 mm
<b>8 251 04 024</b>	<b>Combi double turning holder sq. 20</b>	
	Weight [kg]:	5.710
	Shank size [mm]:	40.00
	Shank type:	BMT
	Machine adaption:	Centering key slot b 12
	Tool adaption:	Sq. 20
		Sq. 20
		Sq. 20
		Sq. 20
	Coolant:	EXT
	Pressure max [bar]:	80
<b>8 251 05 005</b>	<b>Combi double turning holder sq. 1"</b>	
	Weight [kg]:	5.860
	Shank size [mm]:	40.00
	Shank type:	BMT
	Machine adaption:	Centering key slot b 12
	Tool adaption:	Sq. 1" (25,4mm)
		Sq. 1" (25,4mm)
		Sq. 1" (25,4mm)
		Sq. 1" (25,4mm)
	Coolant:	EXT
	Pressure max [bar]:	80
	Please note:	short version; 70 mm
<b>8 251 05 006</b>	<b>Combi double turning holder sq. 25</b>	
	Weight [kg]:	5.860
	Shank size [mm]:	40.00
	Shank type:	BMT
	Machine adaption:	Centering key slot b 12
	Tool adaption:	Sq. 25
		Sq. 25
		Sq. 25
		Sq. 25
	Coolant:	EXT
	Pressure max [bar]:	80
	Please note:	short version; 70 mm
<b>8 251 45 010</b>	<b>Combi double turning holder sq. 25</b>	
	Weight [kg]:	5.880
	Shank size [mm]:	40.00
	Shank type:	BMT
	Machine adaption:	Centering key slot b 12
	Tool adaption:	Sq. 25
		Sq. 25

Part-#	Name	
	Coolant:	Sq. 25 Sq. 25 EXT
<b>8 259 04 005</b>	<b>Multiple turning holder 4x sq.20/ 3/4"</b>	
	Weight [kg]:	7.000
	Employment for:	Main- and sub spindle
	Version:	Y-axes offset
	Shank type:	BMT
	Machine adaption:	Centering key slot b 12
	Tool adaption:	Sq. 20/3/4" (19,05mm) Sq. 20/3/4" (19,05mm) Sq. 20/3/4" (19,05mm) Sq. 20/3/4" (19,05mm)
	Coolant:	EXT
<b>8 320 02 023</b>	<b>Cut-off holder, height adjustable SH 26 IC</b>	
	Weight [kg]:	2.030
	Notation:	180° reversible
	Shank type:	BMT
	Machine adaption:	Centering key slot b 12
	Tool adaption:	Clampshaft SH 26
	Coolant:	IC/Ext
	Pressure max [bar]:	70
<b>8 320 03 033</b>	<b>Cut-off holder, height adjustable SH 32 IC</b>	
	Weight [kg]:	2.290
	Notation:	180° reversible
	Shank type:	BMT
	Machine adaption:	Centering key slot b 12
	Tool adaption:	Clampshaft SH 32
	Coolant:	IC/Ext
	Pressure max [bar]:	70
	Please note:	Clampshaft internal
<b>8 320 09 006</b>	<b>Cut-off holder, height adjustable 845 IC</b>	
	Notation:	180° reversible
	Shank type:	BMT
	Machine adaption:	Centering key slot b 12
	Tool adaption:	 System 845
	Coolant:	IC
	Pressure max [bar]:	70

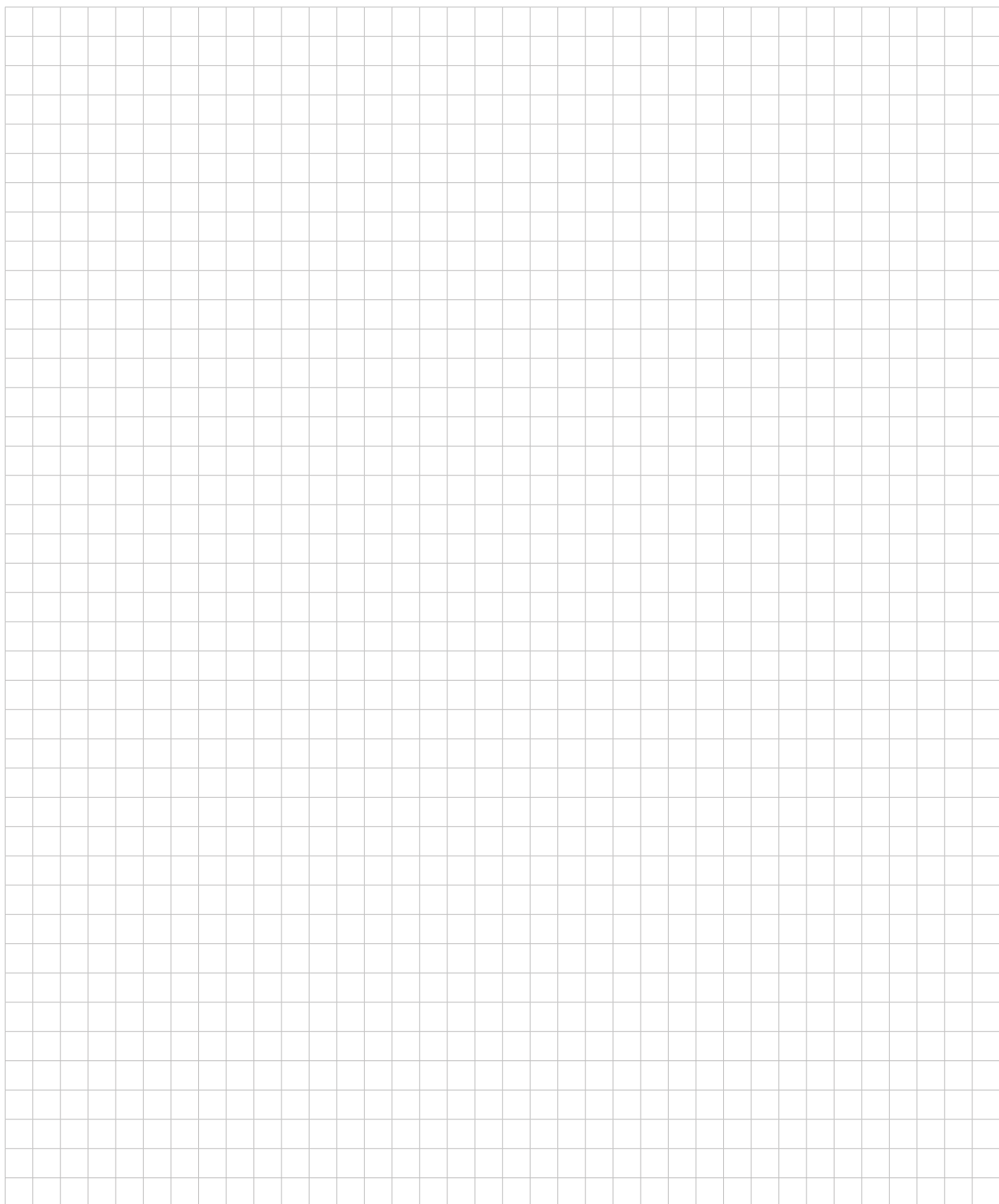

## heimatec.u-tec®

heimatec.com

Products / Tool change systems /  
u-tec® Tool-changing system



versions see catalog

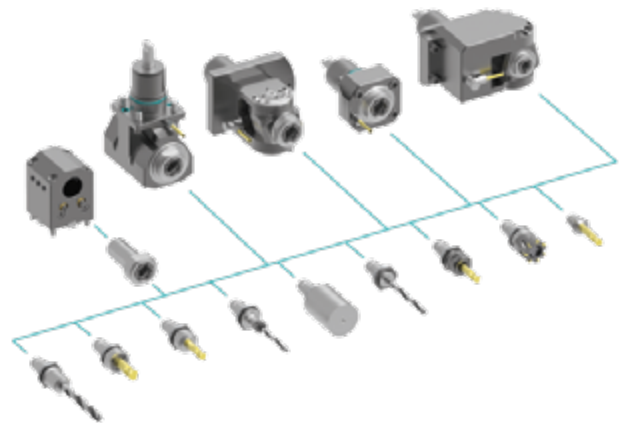

## heimatec.easy-quick

heimatec.com

Products / Tool change systems /  
easy-quick HT quick-changing system



versions see catalog

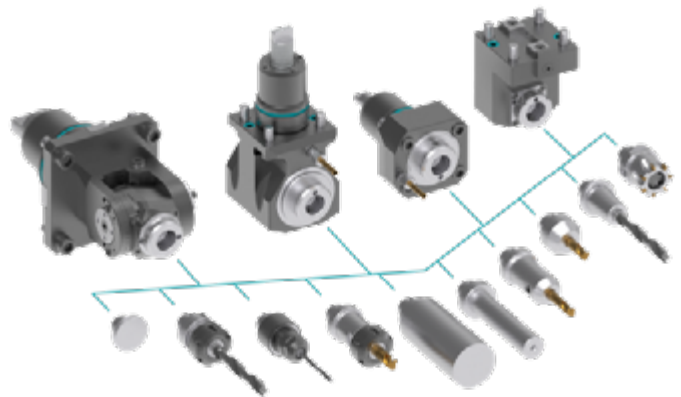

## heimatec.Capto™

heimatec.com

Products / Tool change systems /  
heimatec.Capto™ quick-changing system



versions see catalog

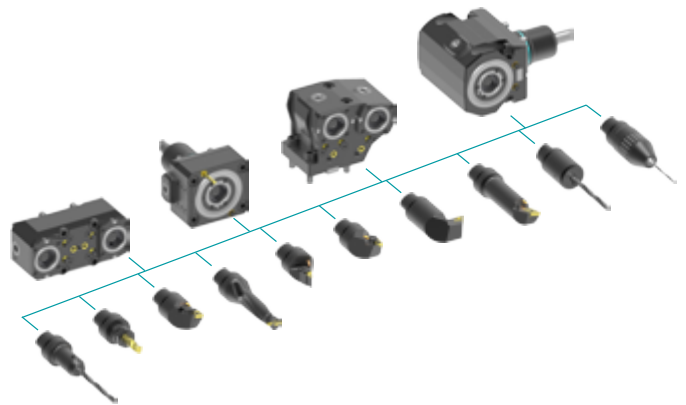

## heimatec.accessories

heimatec.com

Products / Accessories



versions see catalog





● heimatec overseas branches

○ global representations of heimatec

**heimatec**<sup>®</sup>

**heimatec GmbH**  
Präzisionswerkzeuge  
Carl-Benz-Str. 4  
77871 Renchen  
Germany

T +49 7843 9466 0  
[www.heimatec.com](http://www.heimatec.com)  
[info@heimatec.com](mailto:info@heimatec.com)

Please find the contact details of our worldwide trading partners on our website:  
<https://heimatec.com/business-partners>