

Gildemeister  
**Sprint 65 linear**



# High-tech from heimatec - heimatec - Tools and systems for productive turning and milling

heimatec belongs to the international technology and quality leaders for precision tools and specializes in the development and production of high-precision static and live tools for all CNC lathes, CNC turn-/mill machines and CNC machining centers.

The range of products\* spans from static BMT and VDI tool holders, live tools up to highly complex customer-specific individual solutions. heimatec, headquartered in Renchen, has a own subsidiary in Asia and India and numerous representatives as well as trading partners all over the world.

## \*OUR PRODCUTS

Static tool holders

Live tool units

Precision tools

Tools for turning and machining centres

Tools for swiss type lathes

Tool changing and uick-change systems





Tool systems for gear production

Digital tool management

This catalogue, including all its parts, is protected by copyright. Any use outside the restricted limitations of the Copyright Act without the consent of heimatec is inadmissible and liable to prosecution. This applies in particular to duplication, translation, microfilming and storage and processing in electronic systems.

**heimatec GmbH** reserves the right to make technical changes at any time without giving prior notice. This applies in particular to adjustments at any time to meet new or changed international standards, or in case of further developments of our products or manufacturing processes.

The current version of our General Terms and Conditions can be found on our website.

Part-#	Name	
<b>8 010 25 090</b>	<b>Axial drilling and milling head ER 25</b>	
	Weight [kg]:	1.580
	Tool drive:	DIN 5480
	Shank size [mm]:	30.00
	Shank type:	VDI
	Tool adaption:	ER 25
	Gear ratio [i]:	1:1
	Torque max [Nm]:	25
	Rotation max [1/min]:	6000
	Rotating direction:	same
	Coolant:	EXT
	Please note:	round housing ø 68
<b>8 010 25 091</b>	<b>Axial drilling and milling head ER 25 IC</b>	
	Weight [kg]:	1.830
	Tool drive:	DIN 5480
	Shank size [mm]:	30.00
	Shank type:	VDI
	Tool adaption:	ER 25
	Gear ratio [i]:	1:1
	Torque max [Nm]:	25
	Rotation max [1/min]:	6000
	Rotating direction:	same
	Coolant:	IC/Ext
	Pressure max [bar]:	25
	Please note:	round housing ø 68
<b>8 010 25 118</b>	<b>Axial drilling and milling head ER 25 AX UT</b>	
	Weight [kg]:	1.780
	Tool drive:	DIN 5480
	Shank size [mm]:	30.00
	Shank type:	VDI
	Tool adaption:	ER 25 A - u-tec
	Gear ratio [i]:	1:1
	Torque max [Nm]:	25
	Rotation max [1/min]:	12000
	Rotating direction:	same
	Coolant:	EXT
	Please note:	stronger bearing
<b>8 010 25 119</b>	<b>Axial drilling and milling head ER 25 AX UT IC</b>	
	Weight [kg]:	1.780
	Tool drive:	DIN 5480
	Shank size [mm]:	30.00
	Shank type:	VDI
	Tool adaption:	ER 25 A - u-tec
	Gear ratio [i]:	1:1
	Torque max [Nm]:	25
	Rotation max [1/min]:	6000
	Rotating direction:	same
	Coolant:	IC/Ext
	Pressure max [bar]:	25
	Please note:	round housing ø 68

Part-#	Name	
<b>8 013 22 000</b>	<b>Axial drilling and milling head Weldon 6</b>	
	Version:	left
	Tool drive:	DIN 5480
	Shank size [mm]:	30.00
	Shank type:	VDI
	Tool adaption:	Weldon (DIN 1835 b) 6
	Gear ratio [i]:	1:2
	Torque max [Nm]:	8
	Rotation max [1/min]:	8000
	Rotating direction:	same
	Coolant:	EXT
<b>8 013 24 014</b>	<b>Axial drilling and milling head Weldon 10</b>	
	Version:	left
	Tool drive:	DIN 5480
	Shank size [mm]:	30.00
	Shank type:	VDI
	Tool adaption:	Weldon (DIN 1835 b) 10
	Gear ratio [i]:	1:2
	Torque max [Nm]:	8
	Rotation max [1/min]:	8000
	Rotating direction:	same
	Coolant:	EXT
<b>8 013 25 004</b>	<b>Axial drilling and milling head ER 25</b>	
	Weight [kg]:	4.440
	Version:	left
	Tool drive:	DIN 5480
	Shank size [mm]:	30.00
	Shank type:	VDI
	Tool adaption:	ER 25
	Gear ratio [i]:	2:1
	Torque max [Nm]:	40
	Rotation max [1/min]:	3000
	Rotating direction:	same
	Coolant:	EXT
	Please note:	stronger bearing
<b>8 013 25 007</b>	<b>Axial drilling and milling head Weldon 16</b>	
	Weight [kg]:	4.320
	Version:	left
	Tool drive:	DIN 5480
	Shank size [mm]:	30.00
	Shank type:	VDI
	Tool adaption:	Weldon (DIN 1835 b) 16
	Gear ratio [i]:	1:2
	Torque max [Nm]:	8
	Rotation max [1/min]:	8000
	Rotating direction:	same
	Coolant:	EXT
	Please note:	stronger bearing

Part-#	Name	
<b>8 014 25 002</b>	<b>Axial milling head universal arbor 22</b>	
	Tool drive:	DIN 5480
	Shank size [mm]:	30.00
	Shank type:	VDI
	Tool adaption:	Universal arbor 22
	Gear ratio [i]:	2:1
	Torque max [Nm]:	40
	Rotation max [1/min]:	3000
	Rotating direction:	same
	Coolant:	EXT
	Please note:	stronger bearing
<b>8 018 24 002</b>	<b>Axial drilling and milling head ER 16 AX</b>	
	Weight [kg]:	2.800
	Notation:	Y-axes adjustable ± 21 mm
	Tool drive:	DIN 5480
	Shank size [mm]:	30.00
	Shank type:	VDI
	Tool adaption:	ER 16 A
	Gear ratio [i]:	1:1
	Torque max [Nm]:	16
	Rotation max [1/min]:	6000
	Rotating direction:	opposite
	Coolant:	EXT
<b>8 019 25 008</b>	<b>Axial milling head universal arbor 1"</b>	
	Weight [kg]:	5.300
	Notation:	offset
	Version:	left
	Tool drive:	DIN 5480
	Shank size [mm]:	30.00
	Shank type:	VDI
	Tool adaption:	Universal arbor 1" (25,4mm)
	Gear ratio [i]:	2:1
	Torque max [Nm]:	40
	Rotation max [1/min]:	4000
	Rotating direction:	opposite
	Coolant:	EXT
	Please note:	stronger bearing
	Offset [mm]:	34,5
<b>8 019 25 021</b>	<b>Axial drilling and milling head ER 25</b>	
	Weight [kg]:	4.320
	Notation:	offset
	Version:	left
	Tool drive:	DIN 5480
	Shank size [mm]:	30.00
	Shank type:	VDI
	Tool adaption:	ER 25
	Gear ratio [i]:	1:2
	Torque max [Nm]:	12
	Rotation max [1/min]:	12000
	Rotating direction:	opposite
	Coolant:	EXT
	Please note:	stronger bearing
	Offset [mm]:	34,5

Part-#	Name	
<b>8 019 25 025</b>	<b>Axial milling head universal arbor 22</b>	
	Notation:	offset
	Version:	left
	Tool drive:	DIN 5480
	Shank size [mm]:	30.00
	Shank type:	VDI
	Tool adaption:	Universal arbor 22
	Gear ratio [i]:	2:1
	Torque max [Nm]:	40
	Rotation max [1/min]:	4000
	Rotating direction:	opposite
	Coolant:	EXT
	Please note:	stronger bearing
	Offset [mm]:	34,5
<b>8 019 25 027</b>	<b>Axial drilling and milling head ER 25 IC</b>	
	Weight [kg]:	4.360
	Notation:	offset
	Version:	left
	Tool drive:	DIN 5480
	Shank size [mm]:	30.00
	Shank type:	VDI
	Tool adaption:	ER 25
	Gear ratio [i]:	1:3
	Torque max [Nm]:	6
	Rotation max [1/min]:	15000
	Rotating direction:	opposite
	Coolant:	IC/Ext
	Pressure max [bar]:	25
	Please note:	stronger bearing
	Offset [mm]:	34,5
<b>8 019 26 002</b>	<b>Axial drilling and milling head HT 4 IC</b>	
	Weight [kg]:	4.300
	Notation:	offset
	Version:	right
	Tool drive:	DIN 5480
	Shank size [mm]:	30.00
	Shank type:	VDI
	Tool adaption:	HT 4
	Gear ratio [i]:	1:2
	Torque max [Nm]:	12
	Rotation max [1/min]:	12000
	Rotating direction:	opposite
	Coolant:	IC/Ext
	Pressure max [bar]:	25
	Offset [mm]:	34,5
<b>8 030 22 003</b>	<b>Radial drilling and milling head Weldon 6</b>	
	Version:	right
	Tool drive:	DIN 5480
	Shank size [mm]:	30.00
	Shank type:	VDI
	Tool adaption:	Weldon (DIN 1835 b) 6
	Gear ratio [i]:	1:2
	Torque max [Nm]:	8
	Rotation max [1/min]:	8000
	Rotating direction:	opposite

Part-#	Name	
	Coolant:	EXT
	Center distance [mm]:	100
<b>8 030 24 036</b>	<b>Radial drilling and milling head ER 20 AX</b>	
	Version:	left
	Tool drive:	DIN 5480
	Shank size [mm]:	30.00
	Shank type:	VDI
	Tool adaption:	ER 20 A
	Gear ratio [i]:	1:2
	Torque max [Nm]:	8
	Rotation max [1/min]:	12000
	Rotating direction:	opposite
	Coolant:	EXT
	Please note:	Old turret locator distance 46 mm
	Center distance [mm]:	100
<b>8 030 24 037</b>	<b>Radial drilling and milling head ER 20 AX</b>	
	Tool drive:	DIN 5480
	Shank size [mm]:	30.00
	Shank type:	VDI
	Tool adaption:	ER 20 A
	Gear ratio [i]:	1:2
	Torque max [Nm]:	8
	Rotation max [1/min]:	12000
	Rotating direction:	opposite
	Coolant:	EXT
	Please note:	Old turret locator distance 46 mm
	Center distance [mm]:	100
<b>8 030 24 040</b>	<b>Radial drilling and milling head ER 20 AX</b>	
	Weight [kg]:	4.760
	Version:	left
	Tool drive:	DIN 5480
	Shank size [mm]:	30.00
	Shank type:	VDI
	Tool adaption:	ER 20 A
	Gear ratio [i]:	1:2
	Torque max [Nm]:	8
	Rotation max [1/min]:	8000
	Rotating direction:	opposite
	Coolant:	EXT
	Center distance [mm]:	100
<b>8 030 24 067</b>	<b>Radial drilling and milling head ER 20 AX</b>	
	Tool drive:	DIN 5480
	Shank size [mm]:	30.00
	Shank type:	VDI
	Tool adaption:	ER 20 A
	Gear ratio [i]:	1:2
	Torque max [Nm]:	8
	Rotation max [1/min]:	8000
	Rotating direction:	opposite
	Coolant:	EXT
	Center distance [mm]:	100

Part-#	Name
<b>8 030 24 086</b>	<b>Radial drilling and milling head Weldon 10</b>
	Version: right
	Tool drive: DIN 5480
	Shank size [mm]: 30.00
	Shank type: VDI
	Tool adaption: Weldon (DIN 1835 b) 10
	Gear ratio [i]: 1:2
	Torque max [Nm]: 8
	Rotation max [1/min]: 8000
	Rotating direction: opposite
	Coolant: EXT
	Center distance [mm]: 100
<b>8 030 25 021</b>	<b>Radial drilling and milling head ER 25</b>
	Weight [kg]: 3.970
	Version: right
	Tool drive: DIN 5480
	Shank size [mm]: 30.00
	Shank type: VDI
	Tool adaption: ER 25
	Gear ratio [i]: 1:1
	Torque max [Nm]: 25
	Rotation max [1/min]: 6000
	Rotating direction: opposite
	Coolant: EXT
	Center distance [mm]: 100
<b>8 030 25 055</b>	<b>Radial drilling and milling head ER 25</b>
	Weight [kg]: 4.020
	Version: left
	Tool drive: DIN 5480
	Shank size [mm]: 30.00
	Shank type: VDI
	Tool adaption: ER 25
	Gear ratio [i]: 1:1
	Torque max [Nm]: 25
	Rotation max [1/min]: 6000
	Rotating direction: opposite
	Coolant: EXT
	Center distance [mm]: 100
<b>8 030 25 058</b>	<b>Radial drilling and milling head Weldon 16 IC</b>
	Version: left
	Tool drive: DIN 5480
	Shank size [mm]: 30.00
	Shank type: VDI
	Tool adaption: Weldon (DIN 1835 b) 16
	Gear ratio [i]: 1:1
	Torque max [Nm]: 25
	Rotation max [1/min]: 6000
	Rotating direction: opposite
	Coolant: IC/Ext
	Center distance [mm]: 100

Part-#	Name	
<b>8 030 26 013</b>	<b>Radial drilling and milling head Weldon 20 IC</b>	
	Weight [kg]:	4.620
	Version:	left
	Tool drive:	DIN 5480
	Shank size [mm]:	30.00
	Shank type:	VDI
	Tool adaption:	Weldon (DIN 1835 b) 20
	Gear ratio [i]:	1:1
	Torque max [Nm]:	25
	Rotation max [1/min]:	6000
	Rotating direction:	opposite
	Coolant:	IC/Ext
	Please note:	stronger bearing
	Center distance [mm]:	100
<b>8 030 26 054</b>	<b>Radial drilling and milling head HT 4 IC</b>	
	Weight [kg]:	5.060
	Version:	left
	Tool drive:	DIN 5480
	Shank size [mm]:	30.00
	Shank type:	VDI
	Tool adaption:	HT 4
	Gear ratio [i]:	1:3
	Torque max [Nm]:	8
	Rotation max [1/min]:	15000
	Rotating direction:	opposite
	Coolant:	IC/Ext
	Pressure max [bar]:	25
	Center distance [mm]:	100
<b>8 030 26 055</b>	<b>Radial drilling and milling head HT 4</b>	
	Weight [kg]:	4.820
	Version:	left
	Tool drive:	DIN 5480
	Shank size [mm]:	30.00
	Shank type:	VDI
	Tool adaption:	HT 4
	Gear ratio [i]:	1:3
	Torque max [Nm]:	8
	Rotation max [1/min]:	15000
	Rotating direction:	opposite
	Coolant:	EXT
	Center distance [mm]:	100
<b>8 030 26 056</b>	<b>Radial drilling and milling head HT 4 IC</b>	
	Weight [kg]:	5.040
	Version:	right
	Tool drive:	DIN 5480
	Shank size [mm]:	30.00
	Shank type:	VDI
	Tool adaption:	HT 4
	Gear ratio [i]:	1:3
	Torque max [Nm]:	8
	Rotation max [1/min]:	15000
	Rotating direction:	opposite
	Coolant:	IC/Ext
	Pressure max [bar]:	25
	Center distance [mm]:	100

Part-#	Name	
<b>8 031 26 016</b>	<b>Radial milling head universal arbor 27</b>	
	Weight [kg]:	3.430
	Version:	left
	Tool drive:	DIN 5480
	Shank size [mm]:	30.00
	Shank type:	VDI
	Tool adaption:	Universal arbor 27
	Gear ratio [i]:	1:1
	Torque max [Nm]:	25
	Rotation max [1/min]:	6000
	Rotating direction:	opposite
	Coolant:	EXT
	Please note:	stronger bearing
	Center distance [mm]:	64
<b>8 033 25 069</b>	<b>Radial drilling and milling head ER 25</b>	
	Notation:	offset
	Version:	right
	Tool drive:	DIN 5480
	Shank size [mm]:	30.00
	Shank type:	VDI
	Tool adaption:	ER 25
	Gear ratio [i]:	2:1
	Torque max [Nm]:	32
	Rotation max [1/min]:	3000
	Rotating direction:	same
	Coolant:	EXT
	Please note:	stronger bearing
	Center distance [mm]:	97
	Offset [mm]:	34,5
<b>8 033 25 106</b>	<b>Radial drilling and milling head ER 25 IC</b>	
	Notation:	offset
	Version:	left
	Tool drive:	DIN 5480
	Shank size [mm]:	30.00
	Shank type:	VDI
	Tool adaption:	ER 25
	Gear ratio [i]:	1:1
	Torque max [Nm]:	25
	Rotation max [1/min]:	6000
	Rotating direction:	same
	Coolant:	IC/Ext
	Pressure max [bar]:	140
	Center distance [mm]:	100
<b>8 033 26 017</b>	<b>Radial drilling and milling head HT 4 IC</b>	
	Weight [kg]:	5.860
	Notation:	offset
	Version:	left
	Tool drive:	DIN 5480
	Shank size [mm]:	30.00
	Shank type:	VDI
	Tool adaption:	HT 4
	Gear ratio [i]:	1:3
	Torque max [Nm]:	8
	Rotation max [1/min]:	12000
	Rotating direction:	same

Part-#	Name	
	Coolant:	IC/Ext
	Pressure max [bar]:	25
	Center distance [mm]:	100
<b>8 033 26 018</b>	<b>Radial drilling and milling head HT 4</b>	
	Weight [kg]:	5.640
	Notation:	offset
	Version:	left
	Tool drive:	DIN 5480
	Shank size [mm]:	30.00
	Shank type:	VDI
	Tool adaption:	HT 4
	Gear ratio [i]:	1:3
	Torque max [Nm]:	8
	Rotation max [1/min]:	12000
	Rotating direction:	same
	Coolant:	EXT
	Center distance [mm]:	100
<b>8 036 25 002</b>	<b>Radial drilling and milling head ER 25 IC</b>	
	Weight [kg]:	3.990
	Version:	doubletoothed
	Tool drive:	DIN 5480
	Shank size [mm]:	30.00
	Shank type:	VDI
	Tool adaption:	ER 25
	Gear ratio [i]:	1:1
	Torque max [Nm]:	25
	Rotation max [1/min]:	6000
	Rotating direction:	opposite
	Coolant:	IC/Ext
	Pressure max [bar]:	140
	Center distance [mm]:	100
<b>8 036 25 003</b>	<b>Radial drilling and milling head ER 25</b>	
	Weight [kg]:	3.990
	Version:	doubletoothed
	Tool drive:	DIN 5480
	Shank size [mm]:	30.00
	Shank type:	VDI
	Tool adaption:	ER 25
	Gear ratio [i]:	1:1
	Torque max [Nm]:	25
	Rotation max [1/min]:	6000
	Rotating direction:	opposite
	Coolant:	EXT
	Center distance [mm]:	100
<b>8 036 25 041</b>	<b>Radial drilling and milling head ER 25 AX UT</b>	
	Weight [kg]:	4.220
	Notation:	180° reversible
	Version:	doubletoothed
	Tool drive:	DIN 5480
	Shank size [mm]:	30.00
	Shank type:	VDI
	Tool adaption:	ER 25 A - u-tec
	Gear ratio [i]:	1:1
	Torque max [Nm]:	25

Part-#	Name	
	Rotation max [1/min]:	6000
	Rotating direction:	opposite
	Coolant:	EXT
	Please note:	stronger bearing
	Center distance [mm]:	100
<b>8 036 25 042</b>	<b>Radial drilling and milling head ER 25 AX UT IC</b>	
	Weight [kg]:	4.640
	Notation:	180° reversible
	Version:	doubletoothed
	Tool drive:	DIN 5480
	Shank size [mm]:	30.00
	Shank type:	VDI
	Tool adaption:	ER 25 A - u-tec
	Gear ratio [i]:	1:1
	Torque max [Nm]:	25
	Rotation max [1/min]:	6000
	Rotating direction:	opposite
	Coolant:	IC/Ext
	Pressure max [bar]:	140
	Please note:	stronger bearing
	Center distance [mm]:	100
<b>8 039 24 008</b>	<b>Radial drilling and milling head ER 20</b>	
	Version:	double spindle
	Tool drive:	DIN 5480
	Shank size [mm]:	30.00
	Shank type:	VDI
	Tool adaption:	ER 20
	Gear ratio [i]:	1:1
	Torque max [Nm]:	16
	Rotation max [1/min]:	6000
	Rotating direction:	same/opposite
	Coolant:	EXT
	Center distance [mm]:	100
<b>8 039 25 006</b>	<b>Radial drilling and milling head ER 25</b>	
	Weight [kg]:	4.440
	Version:	double spindle
	Tool drive:	DIN 5480
	Shank size [mm]:	30.00
	Shank type:	VDI
	Tool adaption:	ER 25
	Gear ratio [i]:	1:1
	Torque max [Nm]:	25
	Rotation max [1/min]:	6000
	Rotating direction:	same/opposite
	Coolant:	EXT
	Please note:	stronger bearing
	Center distance [mm]:	100
<b>8 039 25 053</b>	<b>Radial drilling and milling head ER 25</b>	
	Weight [kg]:	4.530
	Version:	double spindle; doubletoothed
	Tool drive:	DIN 5480
	Shank size [mm]:	30.00
	Shank type:	VDI
	Tool adaption:	ER 25

Part-#	Name	
		Gear ratio [i]: 1:1 Torque max [Nm]: 25 Rotation max [1/min]: 6000 Rotating direction: same/opposite Coolant: EXT Please note: stronger bearing Center distance [mm]: 100
<b>8 039 26 003</b>	<b>Radial drilling and milling head ER 25 / HT 4</b>	Weight [kg]: 4.480 Version: double spindle Tool drive: DIN 5480 Shank size [mm]: 30.00 Shank type: VDI Tool adaption: HT 4 ER 25 Gear ratio [i]: 1:1 Torque max [Nm]: 16 Rotation max [1/min]: 6000 Rotating direction: same/opposite Coolant: EXT Center distance [mm]: 100
<b>8 039 26 004</b>	<b>Radial drilling and milling head HT 4</b>	Weight [kg]: 4.500 Version: double spindle Tool drive: DIN 5480 Shank size [mm]: 30.00 Shank type: VDI Tool adaption: HT 4 Gear ratio [i]: 1:1 Torque max [Nm]: 25 Rotation max [1/min]: 6000 Rotating direction: same/opposite Coolant: EXT Please note: stronger bearing Center distance [mm]: 100
<b>8 039 26 021</b>	<b>Radial drilling and milling head HT 4</b>	Weight [kg]: 4.600 Version: double spindle Tool drive: DIN 5480 Shank size [mm]: 30.00 Shank type: VDI Tool adaption: HT 4 Gear ratio [i]: 1:1 Torque max [Nm]: 25 Rotation max [1/min]: 6000 Rotating direction: same/opposite Coolant: EXT Please note: Fixation slide stone; stronger bearing Center distance [mm]: 100

Part-#	Name	
<b>8 039 26 026</b>	<b>Radial drilling and milling head HT 4</b>	
	Version:	double spindle; doubletoothed
	Tool drive:	DIN 5480
	Shank size [mm]:	30.00
	Shank type:	VDI
	Tool adaption:	HT 4
	Gear ratio [i]:	1:1
	Torque max [Nm]:	25
	Rotation max [1/min]:	6000
	Rotating direction:	same/opposite
	Coolant:	EXT
	Please note:	stronger bearing
	Center distance [mm]:	100
<b>8 040 24 012</b>	<b>Universal head ± 90° adjustable ER 20</b>	
	Weight [kg]:	2.470
	Version:	right
	Tool drive:	DIN 5480
	Shank size [mm]:	30.00
	Shank type:	VDI
	Tool adaption:	ER 20
	Gear ratio [i]:	1:1
	Torque max [Nm]:	10
	Rotation max [1/min]:	6000
	Rotating direction:	same
	Coolant:	EXT
	Please note:	Fixation 180° reversible
	Center distance [mm]:	64
<b>8 040 24 035</b>	<b>Universal head ± 90° adjustable ER 16</b>	
	Weight [kg]:	2.320
	Version:	right
	Tool drive:	DIN 5480
	Shank size [mm]:	30.00
	Shank type:	VDI
	Tool adaption:	ER 16
	Gear ratio [i]:	1:1
	Torque max [Nm]:	10
	Rotation max [1/min]:	6000
	Rotating direction:	same
	Coolant:	EXT
	Please note:	Fixation 180° reversible
	Center distance [mm]:	64
<b>8 040 24 059</b>	<b>Universal head ± 90° adjustable ER 16 AX UT</b>	
	Weight [kg]:	4.430
	Version:	left
	Tool drive:	DIN 5480
	Shank size [mm]:	30.00
	Shank type:	VDI
	Tool adaption:	ER 16 A - u-tec
	Gear ratio [i]:	1:2
	Torque max [Nm]:	12
	Rotation max [1/min]:	12000
	Rotating direction:	opposite
	Coolant:	EXT
	Center distance [mm]:	88

Part-#	Name
<b>8 040 24 075</b>	<b>Universal head ± 90° adjustable ER 16 AX UT IC</b>
	Weight [kg]: 4.450
	Version: left
	Tool drive: DIN 5480
	Shank size [mm]: 30.00
	Shank type: VDI
	Tool adaption: ER 16 A - u-tec
	Gear ratio [i]: 1:1
	Torque max [Nm]: 25
	Rotation max [1/min]: 6000
	Rotating direction: opposite
	Coolant: IC/Ext
	Pressure max [bar]: 140
	Center distance [mm]: 88
<b>8 040 24 077</b>	<b>Universal head ± 90° adjustable ER 16 AX UT</b>
	Version: left
	Tool drive: DIN 5480
	Shank size [mm]: 30.00
	Shank type: VDI
	Tool adaption: ER 16 A - u-tec
	Gear ratio [i]: 1:1
	Torque max [Nm]: 25
	Rotation max [1/min]: 6000
	Rotating direction: opposite
	Coolant: EXT
	Center distance [mm]: 88
<b>8 040 24 078</b>	<b>Universal head ± 90° adjustable ER 16 AX UT IC</b>
	Version: left
	Tool drive: DIN 5480
	Shank size [mm]: 30.00
	Shank type: VDI
	Tool adaption: ER 16 A - u-tec
	Gear ratio [i]: 1:2
	Torque max [Nm]: 12
	Rotation max [1/min]: 12000
	Rotating direction: opposite
	Coolant: IC/Ext
	Pressure max [bar]: 140
	Center distance [mm]: 88
<b>8 040 24 079</b>	<b>Universal head ± 90° adjustable ER 16 AX UT</b>
	Version: right
	Tool drive: DIN 5480
	Shank size [mm]: 30.00
	Shank type: VDI
	Tool adaption: ER 16 A - u-tec
	Gear ratio [i]: 1:1
	Torque max [Nm]: 25
	Rotation max [1/min]: 6000
	Rotating direction: opposite
	Coolant: EXT
	Center distance [mm]: 88

Part-#	Name
<b>8 040 24 081</b>	<b>Universal head ± 90° adjustable ER 16 AX UT IC</b>
	Weight [kg]: 4.450
	Version: right
	Tool drive: DIN 5480
	Shank size [mm]: 30.00
	Shank type: VDI
	Tool adaption: ER 16 A - u-tec
	Gear ratio [i]: 1:1
	Torque max [Nm]: 25
	Rotation max [1/min]: 6000
	Rotating direction: opposite
	Coolant: IC/Ext
	Pressure max [bar]: 140
	Center distance [mm]: 88
<b>8 040 24 084</b>	<b>Universal head ± 90° adjustable ER 16 AX UT</b>
	Weight [kg]: 4.440
	Version: right
	Tool drive: DIN 5480
	Shank size [mm]: 30.00
	Shank type: VDI
	Tool adaption: ER 16 A - u-tec
	Gear ratio [i]: 1:2
	Torque max [Nm]: 12
	Rotation max [1/min]: 12000
	Rotating direction: opposite
	Coolant: EXT
	Center distance [mm]: 88
<b>8 040 24 087</b>	<b>Universal head ± 90° adjustable ER 16 AX UT IC</b>
	Version: right
	Tool drive: DIN 5480
	Shank size [mm]: 30.00
	Shank type: VDI
	Tool adaption: ER 16 A - u-tec
	Gear ratio [i]: 1:2
	Torque max [Nm]: 12
	Rotation max [1/min]: 12000
	Rotating direction: opposite
	Coolant: IC/Ext
	Pressure max [bar]: 140
	Center distance [mm]: 88
<b>8 040 24 108</b>	<b>Universal head ± 90° adjustable ER 16 AX UT</b>
	Weight [kg]: 4.470
	Version: left, at +45° position can be pinned
	Tool drive: DIN 5480
	Shank size [mm]: 30.00
	Shank type: VDI
	Tool adaption: ER 16 A - u-tec
	Gear ratio [i]: 1:2
	Torque max [Nm]: 12
	Rotation max [1/min]: 12000
	Rotating direction: opposite
	Coolant: EXT
	Center distance [mm]: 88

Part-#	Name	
<b>8 040 25 021</b>	<b>Universal head ± 90° adjustable ER 25 AX UT</b>	
	Weight [kg]:	4.630
	Version:	left
	Tool drive:	DIN 5480
	Shank size [mm]:	30.00
	Shank type:	VDI
	Tool adaption:	ER 25 A - u-tec
	Gear ratio [i]:	1:1
	Torque max [Nm]:	25
	Rotation max [1/min]:	6000
	Rotating direction:	opposite
	Coolant:	EXT
	Please note:	stronger bearing
	Center distance [mm]:	88
<b>8 040 25 022</b>	<b>Universal head ± 90° adjustable ER 25 AX UT IC</b>	
	Weight [kg]:	4.650
	Version:	left
	Tool drive:	DIN 5480
	Shank size [mm]:	30.00
	Shank type:	VDI
	Tool adaption:	ER 25 A - u-tec
	Gear ratio [i]:	1:1
	Torque max [Nm]:	25
	Rotation max [1/min]:	6000
	Rotating direction:	opposite
	Coolant:	IC/Ext
	Pressure max [bar]:	140
	Please note:	stronger bearing
	Center distance [mm]:	88
<b>8 040 25 040</b>	<b>Universal head ± 90° adjustable ER 25 AX UT IC</b>	
	Weight [kg]:	3.500
	Version:	right
	Tool drive:	DIN 5480
	Shank size [mm]:	30.00
	Shank type:	VDI
	Tool adaption:	ER 25 A - u-tec
	Gear ratio [i]:	1:1
	Torque max [Nm]:	25
	Rotation max [1/min]:	6000
	Rotating direction:	opposite
	Coolant:	IC/Ext
	Pressure max [bar]:	140
	Please note:	stronger bearing
	Center distance [mm]:	88
<b>8 200 20 000</b>	<b>Plug Z2-30 K</b>	
	Weight [kg]:	0.060
	Shank size [mm]:	30.00
	Shank type:	VDI
<b>8 200 20 005</b>	<b>Plug Z2-30 S</b>	
	Weight [kg]:	0.740
	Shank size [mm]:	30.00
	Shank type:	VDI

Part-#	Name	
<b>8 202 20 012</b>	<b>Basic holder longitudinal seat FN 12</b>	
	Weight [kg]:	1.160
	Version:	universal
	Shank size [mm]:	30.00
	Shank type:	VDI
	Tool adaption:	Interface FN 12
	Coolant:	EXT
<b>8 210 26 011</b>	<b>Tool holder HT 4 IC</b>	
	Weight [kg]:	1.270
	Version:	right
	Shank size [mm]:	30.00
	Shank type:	VDI
	Tool adaption:	HT 4
	Coolant:	IC/Ext
<b>8 210 26 012</b>	<b>Tool holder HT 4 IC</b>	
	Version:	left
	Shank size [mm]:	30.00
	Shank type:	VDI
	Tool adaption:	HT 4
	Coolant:	IC/Ext
<b>8 214 22 000</b>	<b>Tool holder C1-30x20/16</b>	
	Employment for:	VDI 30
	Version:	right
	Shank size [mm]:	30.00
	Shank type:	VDI
	Tool adaption:	Sq. 20/16
	Coolant:	EXT
<b>8 214 22 001</b>	<b>Tool holder C3-30x20/16</b>	
	Employment for:	VDI 30
	Version:	right
	Shank size [mm]:	30.00
	Shank type:	VDI
	Tool adaption:	Sq. 20/16
	Coolant:	EXT
<b>8 215 22 000</b>	<b>Tool holder C2-30x20</b>	
	Weight [kg]:	1.980
	Employment for:	VDI 30
	Version:	left
	Shank size [mm]:	30.00
	Shank type:	VDI
	Tool adaption:	Sq. 20/16
	Coolant:	EXT
<b>8 215 22 001</b>	<b>Tool holder C4-30x20</b>	
	Employment for:	VDI 30
	Version:	left
	Shank type:	VDI
	Tool adaption:	Sq. 20/16
	Coolant:	EXT

Part-#	Name	
<b>8 230 25 007</b>	<b>Collet chuck holder ER 25</b>	
	Weight [kg]:	3.870
	Version:	right
	Shank size [mm]:	30.00
	Shank type:	VDI
	Tool adaption:	ER 25
	Coolant:	IC/Ext
	Please note:	demountable in left version
	Center distance [mm]:	100
<b>8 230 26 022</b>	<b>Tool holder HT 4</b>	
	Weight [kg]:	3.940
	Version:	doubletoothed
	Shank size [mm]:	30.00
	Shank type:	VDI
	Tool adaption:	HT 4
	Coolant:	IC/Ext
	Please note:	HT- insert demountable
	Center distance [mm]:	100
<b>8 230 26 023</b>	<b>Tool holder HT 4</b>	
	Version:	right
	Shank size [mm]:	30.00
	Shank type:	VDI
	Tool adaption:	HT 4
	Coolant:	IC/Ext
	Please note:	demountable in left version
	Center distance [mm]:	100
<b>8 230 26 038</b>	<b>Tool holder HT 4</b>	
	Employment for:	Heavy duty cutting
	Version:	right
	Shank size [mm]:	30.00
	Shank type:	VDI
	Tool adaption:	HT 4
	Coolant:	IC/Ext
	Please note:	demountable in left version
	Center distance [mm]:	100
<b>8 230 27 033</b>	<b>Boring bar holder Ø 25</b>	
	Weight [kg]:	4.570
	Employment for:	Heavy duty cutting
	Version:	right
	Shank size [mm]:	30.00
	Shank type:	VDI
	Tool adaption:	Ø 25
	Coolant:	IC/Ext
	Please note:	demountable in left version
	Center distance [mm]:	100
<b>8 230 28 003</b>	<b>Boring bar holder Ø 32</b>	
	Weight [kg]:	4.455
	Version:	right
	Shank size [mm]:	30.00
	Shank type:	VDI
	Tool adaption:	Ø 32
	Coolant:	IC/Ext
	Please note:	demountable in left version

Part-#	Name	
	Center distance [mm]:	100
<b>8 230 28 031</b>	<b>Boring bar holder Ø 32</b>	
	Weight [kg]:	4.400
	Employment for:	Heavy duty cutting
	Version:	right
	Shank size [mm]:	30.00
	Shank type:	VDI
	Tool adaption:	Ø 32
	Coolant:	IC/Ext
	Please note:	demountable in left version
	Center distance [mm]:	100
<b>8 231 25 000</b>	<b>Collet chuck holder ER 25</b>	
	Weight [kg]:	3.880
	Version:	left
	Shank size [mm]:	30.00
	Shank type:	VDI
	Tool adaption:	ER 25
	Coolant:	IC/Ext
	Please note:	demountable in right version
	Center distance [mm]:	100
<b>8 231 25 011</b>	<b>Collet chuck holder ER 25</b>	
	Employment for:	Heavy duty cutting
	Version:	left
	Shank size [mm]:	30.00
	Shank type:	VDI
	Tool adaption:	ER 25
	Coolant:	IC/Ext
	Please note:	demountable in right version
	Center distance [mm]:	100
<b>8 231 26 011</b>	<b>Tool holder HT 4</b>	
	Version:	left
	Shank size [mm]:	30.00
	Shank type:	VDI
	Tool adaption:	HT 4
	Coolant:	IC/Ext
	Please note:	demountable in right version
	Center distance [mm]:	100
<b>8 231 26 020</b>	<b>Collet chuck holder ER 32</b>	
	Employment for:	Heavy duty cutting
	Version:	left
	Shank size [mm]:	30.00
	Shank type:	VDI
	Tool adaption:	ER 32
	Coolant:	IC/Ext
	Please note:	demountable in right version
	Center distance [mm]:	100

Part-#	Name	
<b>8 231 26 024</b>	<b>Tool holder HT 4</b>	
	Employment for:	Heavy duty cutting
	Version:	left
	Shank size [mm]:	30.00
	Shank type:	VDI
	Tool adaption:	HT 4
	Coolant:	IC/Ext
	Please note:	demountable in right version
	Center distance [mm]:	100
<b>8 231 26 027</b>	<b>Boring bar holder Ø 20</b>	
	Version:	left
	Shank size [mm]:	30.00
	Shank type:	VDI
	Tool adaption:	Ø 20
	Coolant:	IC/Ext
	Please note:	demountable in right version
	Center distance [mm]:	100
<b>8 231 27 010</b>	<b>Boring bar holder Ø 25</b>	
	Employment for:	Heavy duty cutting
	Version:	left
	Shank size [mm]:	30.00
	Shank type:	VDI
	Tool adaption:	Ø 25
	Coolant:	IC/Ext
	Please note:	demountable in right version
	Center distance [mm]:	100
<b>8 234 22 000</b>	<b>Tool holder B3-30x20x40</b>	
	Employment for:	VDI 30
	Shank size [mm]:	30.00
	Shank type:	VDI
	Tool adaption:	Sq. 20/16
	Coolant:	EXT
<b>8 234 22 001</b>	<b>Tool holder B1-30x20x40</b>	
	Employment for:	VDI 30
	Version:	right
	Shank size [mm]:	30.00
	Shank type:	VDI
	Tool adaption:	Sq. 20/16
	Coolant:	EXT
<b>8 234 22 002</b>	<b>Tool holder B5-30x20x40</b>	
	Weight [kg]:	1.790
	Shank size [mm]:	30.00
	Shank type:	VDI
	Tool adaption:	Sq. 20/16
	Coolant:	EXT

Part-#	Name	
<b>8 234 22 003</b>	<b>Tool holder B1-30x20x60</b>	
	Employment for:	VDI 30
	Version:	right
	Shank size [mm]:	30.00
	Shank type:	VDI
	Tool adaption:	Sq. 20/16
	Coolant:	EXT
<b>8 234 22 004</b>	<b>Tool holder B3-30x20x60</b>	
	Employment for:	VDI 30
	Shank size [mm]:	30.00
	Shank type:	VDI
	Tool adaption:	Sq. 20/16
	Coolant:	EXT
<b>8 234 22 005</b>	<b>Tool holder B5-30x20x60</b>	
	Shank size [mm]:	30.00
	Shank type:	VDI
	Tool adaption:	Sq. 20/16
	Coolant:	EXT
<b>8 234 22 006</b>	<b>Tool holder B7-30x20x40</b>	
	Weight [kg]:	1.960
	Shank size [mm]:	30.00
	Shank type:	VDI
	Tool adaption:	Sq. 20/16
	Coolant:	EXT
<b>8 234 22 007</b>	<b>Tool holder B7-30x20x60</b>	
	Weight [kg]:	2.880
	Employment for:	VDI 30
	Shank size [mm]:	30.00
	Shank type:	VDI
	Tool adaption:	Sq. 20/16
	Coolant:	EXT
<b>8 234 22 014</b>	<b>Tool holder B1-30x20x80 special</b>	
	Shank size [mm]:	30.00
	Shank type:	VDI
	Tool adaption:	Sq. 20/16
	Coolant:	EXT
<b>8 234 22 015</b>	<b>Tool holder B1-30x20x90 special</b>	
	Shank size [mm]:	30.00
	Shank type:	VDI
	Tool adaption:	Sq. 20/16
	Coolant:	EXT
<b>8 234 24 003</b>	<b>Combi facing holder 30x20x 92</b>	
	Weight [kg]:	4.750
	Shank size [mm]:	30.00
	Shank type:	VDI
	Tool adaption:	Sq. 20
	Coolant:	EXT

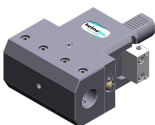

Part-#	Name	
<b>8 235 22 000</b>	<b>Tool holder B2-30x20x40</b>	
	Employment for:	VDI 30
	Version:	left
	Shank size [mm]:	30.00
	Shank type:	VDI
	Tool adaption:	Sq. 20/16
	Coolant:	EXT
<b>8 235 22 001</b>	<b>Tool holder B2-30x20x60</b>	
	Employment for:	VDI 30
	Version:	left
	Shank size [mm]:	30.00
	Shank type:	VDI
	Tool adaption:	Sq. 20/16
	Coolant:	EXT
<b>8 235 22 002</b>	<b>Tool holder B4-30x20x40</b>	
	Weight [kg]:	1.360
	Employment for:	VDI 30
	Version:	left
	Shank size [mm]:	30.00
	Shank type:	VDI
	Tool adaption:	Sq. 20/16
	Coolant:	EXT
<b>8 235 22 003</b>	<b>Tool holder B4-30x20x60</b>	
	Employment for:	VDI 30
	Version:	left
	Shank size [mm]:	30.00
	Shank type:	VDI
	Tool adaption:	Sq. 20/16
	Coolant:	EXT
<b>8 235 22 004</b>	<b>Tool holder B6-30x20x40</b>	
	Weight [kg]:	1.860
	Version:	Left
	Shank size [mm]:	30.00
	Shank type:	VDI
	Tool adaption:	Sq. 20/16
	Coolant:	EXT
<b>8 235 22 005</b>	<b>Tool holder B6-30x20x60</b>	
	Weight [kg]:	2.450
	Version:	Left
	Shank size [mm]:	30.00
	Shank type:	VDI
	Tool adaption:	Sq. 20/16
	Coolant:	EXT
<b>8 235 22 006</b>	<b>Tool holder B8-30x20x40</b>	
	Weight [kg]:	1.880
	Version:	Left
	Shank size [mm]:	30.00
	Shank type:	VDI
	Tool adaption:	Sq. 20/16
	Coolant:	EXT

Part-#	Name	
<b>8 235 22 007</b>	<b>Tool holder B8-30x20x60</b>	
	Version:	Left
	Shank size [mm]:	30.00
	Shank type:	VDI
	Tool adaption:	Sq. 20/16
	Coolant:	EXT
<b>8 239 25 016</b>	<b>Double collet chuck holder ER 25</b>	
	Shank size [mm]:	30.00
	Shank type:	VDI
	Tool adaption:	ER 25
	Coolant:	IC/Ext
	Center distance [mm]:	100
<b>8 239 25 020</b>	<b>Double collet chuck holder ER 25</b>	
	Weight [kg]:	3.910
	Employment for:	Heavy duty cutting
	Shank size [mm]:	30.00
	Shank type:	VDI
	Tool adaption:	ER 25
	Coolant:	IC/Ext
	Center distance [mm]:	100
<b>8 239 26 013</b>	<b>Double tool holder HT 4</b>	
	Employment for:	Main- and sub spindle
	Shank size [mm]:	30.00
	Shank type:	VDI
	Tool adaption:	HT 4
	Coolant:	IC/Ext
	Center distance [mm]:	100
<b>8 239 26 024</b>	<b>Double tool holder HT 4</b>	
	Employment for:	Heavy duty cutting
	Shank size [mm]:	30.00
	Shank type:	VDI
	Tool adaption:	HT 4
	Coolant:	IC/Ext
	Center distance [mm]:	100
<b>8 239 27 006</b>	<b>Double boring bar holder Ø 25</b>	
	Shank size [mm]:	30.00
	Shank type:	VDI
	Tool adaption:	Ø 25
	Coolant:	IC/Ext
	Center distance [mm]:	100
<b>8 239 28 000</b>	<b>Double boring bar holder Ø 32</b>	
	Weight [kg]:	6.240
	Shank size [mm]:	30.00
	Tool adaption:	Ø 32
	Coolant:	IC/Ext
	Center distance [mm]:	100

Part-#	Name	
<b>8 239 28 011</b>	<b>Double boring bar holder Ø 32</b>	
	Weight [kg]:	5.900
	Employment for:	Heavy duty cutting
	Shank size [mm]:	30.00
	Shank type:	VDI
	Tool adaption:	Ø 32
	Coolant:	IC/Ext
	Center distance [mm]:	100
<b>8 251 24 002</b>	<b>Combi double turning holder sq. 20</b>	
	Weight [kg]:	4.600
	Shank size [mm]:	30.00
	Shank type:	VDI
	Tool adaption:	Sq. 20
	Coolant:	EXT
<b>8 274 22 000</b>	<b>Tool holder D2-30x20</b>	
	Weight [kg]:	2.220
	Shank size [mm]:	30.00
	Shank type:	VDI
	Tool adaption:	Sq. 20/16
	Coolant:	EXT
<b>8 274 22 001</b>	<b>Tool holder D1-30x20</b>	
	Weight [kg]:	2.040
	Shank size [mm]:	30.00
	Shank type:	VDI
	Tool adaption:	Sq. 20/16
	Coolant:	EXT
<b>8 320 22 019</b>	<b>Cut-off holder, height adjustable SH 26 IC</b>	
	Weight [kg]:	1.510
	Version:	universal
	Shank size [mm]:	30.00
	Shank type:	VDI
	Tool adaption:	Clampshaft SH 26
	Coolant:	IC/Ext
	Pressure max [bar]:	70
<b>8 320 23 013</b>	<b>Cut-off holder, height adjustable SH 32 IC</b>	
	Weight [kg]:	1.720
	Version:	universal
	Shank size [mm]:	30.00
	Shank type:	VDI
	Tool adaption:	Clampshaft SH 32
	Coolant:	IC/Ext
	Pressure max [bar]:	70
<b>8 320 23 018</b>	<b>Cut-off holder, height adjustable SH 32 IC</b>	
	Weight [kg]:	1.910
	Version:	universal
	Shank size [mm]:	30.00
	Shank type:	VDI
	Tool adaption:	Clampshaft SH 32
	Coolant:	IC/Ext
	Pressure max [bar]:	70
	Please note:	Clampshaft internal

Part-#	Name	
<b>8 320 23 038</b>	<b>Cut-off holder, height adjustable SH 32 IC</b>	
	Weight [kg]:	1.900
	Version:	universal
	Shank size [mm]:	30.00
	Shank type:	VDI
	Tool adaption:	Clampshaft SH 32
	Coolant:	IC/Ext
	Pressure max [bar]:	70
	Please note:	Clampshaft internal, check applicability!
<b>8 320 29 002</b>	<b>Cut-off holder, height adjustable 845 IC</b>	
	Weight [kg]:	1.630
	Version:	universal
	Shank size [mm]:	30.00
	Shank type:	VDI
	Tool adaption:	 System 845
	Coolant:	IC
	Pressure max [bar]:	70

## heimatec.u-tec®

heimatec.com

Products / Tool change systems /  
u-tec® Tool-changing system



versions see catalog



## heimatec.easy-quick

heimatec.com

Products / Tool change systems /  
easy-quick HT quick-changing system



versions see catalog



## heimatec.Capto™

heimatec.com

Products / Tool change systems /  
heimatec.Capto™ quick-changing system



versions see catalog

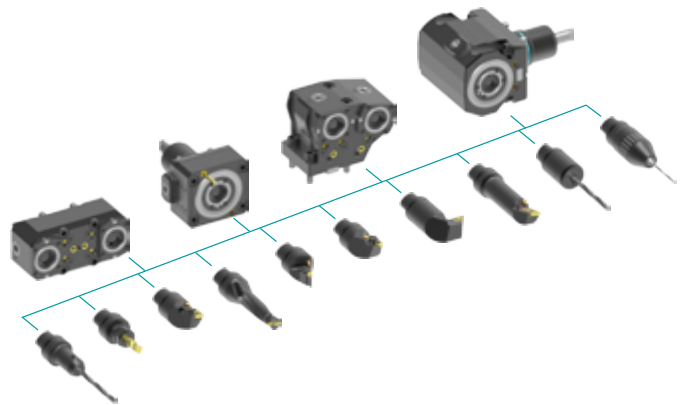

## heimatec.accessories

heimatec.com

Products / Accessories



versions see catalog





● heimatec overseas branches

○ global representations of heimatec

**heimatec**<sup>®</sup>

**heimatec GmbH**  
Präzisionswerkzeuge  
Carl-Benz-Str. 4  
77871 Renchen  
Germany

T +49 7843 9466 0  
[www.heimatec.com](http://www.heimatec.com)  
[info@heimatec.com](mailto:info@heimatec.com)

Please find the contact details of our worldwide trading partners on our website:  
<https://heimatec.com/business-partners>