

Goodway
GA 230 LM - VDI
30 DIN 5482



High-tech from heimatec - heimatec - Tools and systems for productive turning and milling

heimatec belongs to the international technology and quality leaders for precision tools and specializes in the development and production of high-precision static and live tools for all CNC lathes, CNC turn-/mill machines and CNC machining centers.

The range of products* spans from static BMT and VDI tool holders, live tools up to highly complex customer-specific individual solutions. heimatec, headquartered in Renchen, has a own subsidiary in Asia and India and numerous representatives as well as trading partners all over the world.

*OUR PRODCUTS

Static tool holders

Live tool units

Precision tools

Tools for turning and machining centres

Tools for swiss type lathes

Tool changing and uick-change systems



Tool systems for gear production



Digital tool management



This catalogue, including all its parts, is protected by copyright. Any use outside the restricted limitations of the Copyright Act without the consent of heimatec is inadmissible and liable to prosecution. This applies in particular to duplication, translation, microfilming and storage and processing in electronic systems.





heimatec GmbH reserves the right to make technical changes at any time without giving prior notice. This applies in particular to adjustments at any time to meet new or changed international standards, or in case of further developments of our products or manufacturing processes.

The current version of our General Terms and Conditions can be found on our website.

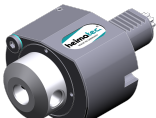
Part-#	Name	
8 010 22 004	Axial drilling and milling head Weldon 6	
	Tool drive:	DIN 5482
	Shank size [mm]:	30.00
	Shank type:	VDI
	Tool adaption:	Weldon (DIN 1835 b) 6
	Gear ratio [i]:	1:1
	Torque max [Nm]:	16
	Rotation max [1/min]:	6000
	Rotating direction:	same
	Coolant:	EXT
8 010 23 004	Axial drilling and milling head Weldon 8	
	Tool drive:	DIN 5482
	Shank size [mm]:	30.00
	Shank type:	VDI
	Tool adaption:	Weldon (DIN 1835 b) 8
	Gear ratio [i]:	1:1
	Torque max [Nm]:	16
	Rotation max [1/min]:	6000
	Rotating direction:	same
	Coolant:	EXT
8 010 24 002	Axial drilling and milling head ER 20	
	Weight [kg]:	1.400
	Tool drive:	DIN 5482
	Shank size [mm]:	30.00
	Shank type:	VDI
	Tool adaption:	ER 20
	Gear ratio [i]:	1:1
	Torque max [Nm]:	25
	Rotation max [1/min]:	6000
	Rotating direction:	same
	Coolant:	EXT
8 010 24 022	Axial drilling head b 16 IC	
	Tool drive:	DIN 5482
	Shank size [mm]:	30.00
	Shank type:	VDI
	Tool adaption:	DIN 238 - b 16
	Gear ratio [i]:	1:1
	Torque max [Nm]:	16
	Rotation max [1/min]:	6000
	Rotating direction:	same
	Coolant:	IC/Ext
8 010 24 033	Axial drilling and milling head Weldon 10	
	Tool drive:	DIN 5482
	Shank size [mm]:	30.00
	Shank type:	VDI
	Tool adaption:	Weldon (DIN 1835 b) 10
	Gear ratio [i]:	1:1
	Torque max [Nm]:	16
	Rotation max [1/min]:	6000
	Rotating direction:	same
	Coolant:	EXT

Part-#	Name	
8 010 24 036	Axial drilling and milling head Weldon 14	
	Tool drive:	DIN 5482
	Shank size [mm]:	30.00
	Shank type:	VDI
	Tool adaption:	Weldon (DIN 1835 b) 14
	Gear ratio [i]:	1:1
	Torque max [Nm]:	16
	Rotation max [1/min]:	6000
	Rotating direction:	same
	Coolant:	EXT
8 010 24 040	Axial drilling and milling head C 12	
	Tool drive:	DIN 5482
	Shank size [mm]:	30.00
	Shank type:	VDI
	Tool adaption:	DIN 6388 - C 12
	Gear ratio [i]:	1:1
	Torque max [Nm]:	16
	Rotation max [1/min]:	6000
	Rotating direction:	same
	Coolant:	EXT
8 010 24 055	Axial drilling and milling head ER 16	
	Weight [kg]:	1.900
	Tool drive:	DIN 5482
	Shank size [mm]:	30.00
	Shank type:	VDI
	Tool adaption:	ER 16
	Gear ratio [i]:	1:1
	Torque max [Nm]:	16
	Rotation max [1/min]:	6000
	Rotating direction:	same
	Coolant:	EXT
8 010 25 000	Axial drilling and milling head ER 25	
	Weight [kg]:	1.480
	Tool drive:	DIN 5482
	Shank size [mm]:	30.00
	Shank type:	VDI
	Tool adaption:	ER 25
	Gear ratio [i]:	1:1
	Torque max [Nm]:	25
	Rotation max [1/min]:	6000
	Rotating direction:	same
	Coolant:	EXT
8 010 25 006	Axial drilling and milling head ER 25 AX UT IC	
	Weight [kg]:	1.630
	Tool drive:	DIN 5482
	Shank size [mm]:	30.00
	Shank type:	VDI
	Tool adaption:	ER 25 A - u-tec
	Gear ratio [i]:	1:1
	Torque max [Nm]:	16
	Rotation max [1/min]:	6000
	Rotating direction:	same
	Coolant:	IC/Ext

Part-#	Name	
	Pressure max [bar]:	25
	Please note:	round housing Ø 68
8 010 25 018	Axial drilling and milling head ER 25 IC air	
	Weight [kg]:	1.910
	Tool drive:	DIN 5482
	Shank size [mm]:	30.00
	Shank type:	VDI
	Tool adaption:	ER 25
	Gear ratio [i]:	1:1
	Torque max [Nm]:	16
	Rotation max [1/min]:	6000
	Rotating direction:	same
	Coolant:	IC air
	Pressure max [bar]:	10
8 010 25 042	Axial drilling and milling head ER 25 IC	
	Weight [kg]:	1.710
	Tool drive:	DIN 5482
	Shank size [mm]:	30.00
	Shank type:	VDI
	Tool adaption:	ER 25
	Gear ratio [i]:	1:1
	Torque max [Nm]:	25
	Rotation max [1/min]:	6000
	Rotating direction:	same
	Coolant:	IC/Ext
	Pressure max [bar]:	25
	Please note:	round housing ø 68
8 010 25 043	Axial drilling and milling head Weldon 16 IC	
	Tool drive:	DIN 5482
	Shank size [mm]:	30.00
	Shank type:	VDI
	Tool adaption:	Weldon (DIN 1835 b) 16
	Gear ratio [i]:	1:1
	Torque max [Nm]:	16
	Rotation max [1/min]:	6000
	Rotating direction:	same
	Coolant:	IC/Ext
	Pressure max [bar]:	25
8 010 25 061	Axial drilling and milling head ER 25	
	Weight [kg]:	3.400
	Version:	Special
	Tool drive:	DIN 5482
	Shank size [mm]:	30.00
	Shank type:	VDI
	Tool adaption:	ER 25
	Gear ratio [i]:	1:1
	Torque max [Nm]:	16
	Rotation max [1/min]:	6000
	Rotating direction:	same
	Coolant:	EXT
	Please note:	stronger bearing, extended housing

Part-#	Name	
8 010 25 132	Axial drilling and milling head ER 25 AX UT	
	Weight [kg]:	1.660
	Tool drive:	DIN 5482
	Shank size [mm]:	30.00
	Shank type:	VDI
	Tool adaption:	ER 25 A - u-tec
	Gear ratio [i]:	1:1
	Torque max [Nm]:	16
	Rotation max [1/min]:	8000
	Rotating direction:	same
	Coolant:	EXT
	Please note:	round housing ø 68; stronger bearing
8 010 26 002	Axial drilling and milling head Weldon 20	
	Tool drive:	DIN 5482
	Shank size [mm]:	30.00
	Shank type:	VDI
	Tool adaption:	Weldon (DIN 1835 b) 20
	Gear ratio [i]:	1:1
	Torque max [Nm]:	16
	Rotation max [1/min]:	6000
	Rotating direction:	same
	Coolant:	EXT
	Please note:	round housing Ø 68, stronger bearing
8 010 26 011	Axial drilling and milling head HT 4 IC	
	Weight [kg]:	1.640
	Tool drive:	DIN 5482
	Shank size [mm]:	30.00
	Shank type:	VDI
	Tool adaption:	HT 4
	Gear ratio [i]:	1:1
	Torque max [Nm]:	16
	Rotation max [1/min]:	6000
	Rotating direction:	same
	Coolant:	IC/Ext
	Pressure max [bar]:	25
	Please note:	round housing ø 68
8 010 26 016	Axial drilling and milling head HT 4	
	Weight [kg]:	1.410
	Tool drive:	DIN 5482
	Shank size [mm]:	30.00
	Shank type:	VDI
	Tool adaption:	HT 4
	Gear ratio [i]:	1:1
	Torque max [Nm]:	25
	Rotation max [1/min]:	6000
	Rotating direction:	same
	Coolant:	EXT

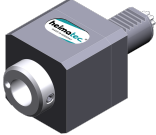
Part-#	Name	
8 010 26 021	Axial drilling and milling head ER 32 IC	
	Weight [kg]:	2.800
	Tool drive:	DIN 5482
	Shank size [mm]:	30.00
	Shank type:	VDI
	Tool adaption:	ER 32
	Gear ratio [i]:	1:1
	Torque max [Nm]:	16
	Rotation max [1/min]:	6000
	Rotating direction:	same
	Coolant:	IC/Ext
	Pressure max [bar]:	25
	Please note:	stronger bearing
8 010 26 028	Axial drilling and milling head HT 4 IC air	
	Tool drive:	DIN 5482
	Shank size [mm]:	30.00
	Shank type:	VDI
	Tool adaption:	HT 4
	Gear ratio [i]:	1:1
	Torque max [Nm]:	16
	Rotation max [1/min]:	6000
	Rotating direction:	same
	Coolant:	IC air
	Pressure max [bar]:	10
8 011 24 000	Axial milling head universal arbor 16	
	Weight [kg]:	1.940
	Tool drive:	DIN 5482
	Shank size [mm]:	30.00
	Shank type:	VDI
	Tool adaption:	Universal arbor 16
	Gear ratio [i]:	1:1
	Torque max [Nm]:	16
	Rotation max [1/min]:	6000
	Rotating direction:	same
	Coolant:	EXT
8 011 25 004	Axial milling head universal arbor 22	
	Tool drive:	DIN 5482
	Shank size [mm]:	30.00
	Shank type:	VDI
	Tool adaption:	Universal arbor 22
	Gear ratio [i]:	1:1
	Torque max [Nm]:	16
	Rotation max [1/min]:	6000
	Rotating direction:	same
	Coolant:	EXT
	Please note:	stronger bearing
8 011 26 000	Axial milling head universal arbor 27	
	Weight [kg]:	2.480
	Tool drive:	DIN 5482
	Shank size [mm]:	30.00
	Shank type:	VDI
	Tool adaption:	Universal arbor 27
	Gear ratio [i]:	1:1

Part-#	Name	
	Torque max [Nm]:	16
	Rotation max [1/min]:	6000
	Rotating direction:	same
	Coolant:	EXT
	Please note:	stronger bearing
8 013 24 003	Axial drilling and milling head ER 20 AX IC	
	Version:	right
	Tool drive:	DIN 5482
	Shank size [mm]:	30.00
	Shank type:	VDI
	Tool adaption:	ER 20 A
	Gear ratio [i]:	1:3
	Torque max [Nm]:	5
	Rotation max [1/min]:	15000
	Rotating direction:	same
	Coolant:	IC air
	Pressure max [bar]:	10
8 013 24 005	Axial drilling and milling head ER 20 AS	
	Weight [kg]:	3.620
	Version:	right
	Tool drive:	DIN 5482
	Shank size [mm]:	30.00
	Shank type:	VDI
	Tool adaption:	ER 20 A
	Gear ratio [i]:	1:3
	Torque max [Nm]:	6
	Rotation max [1/min]:	15500
	Rotating direction:	same
	Coolant:	EXT
8 013 24 016	Axial drilling and milling head ER 20 AX IC	
	Version:	right
	Tool drive:	DIN 5482
	Shank size [mm]:	30.00
	Shank type:	VDI
	Tool adaption:	ER 20 A
	Gear ratio [i]:	1:3
	Torque max [Nm]:	5
	Rotation max [1/min]:	15000
	Rotating direction:	same
	Coolant:	IC/Ext
	Pressure max [bar]:	25
8 013 25 000	Axial drilling and milling head ER 25	
	Version:	right
	Tool drive:	DIN 5482
	Shank size [mm]:	30.00
	Shank type:	VDI
	Tool adaption:	ER 25
	Gear ratio [i]:	2:1
	Torque max [Nm]:	32
	Rotation max [1/min]:	3000
	Rotating direction:	same
	Coolant:	EXT
	Please note:	stronger bearing

Part-#	Name	
8 013 26 000	Axial drilling and milling head ER 32	
	Version:	right
	Tool drive:	DIN 5482
	Shank size [mm]:	30.00
	Shank type:	VDI
	Tool adaption:	ER 32
	Gear ratio [i]:	4:1
	Torque max [Nm]:	64
	Rotation max [1/min]:	1000
	Rotating direction:	same
	Coolant:	EXT
	Please note:	stronger bearing
8 014 26 000	Axial milling head universal arbor 27	
	Version:	right
	Tool drive:	DIN 5482
	Shank size [mm]:	30.00
	Shank type:	VDI
	Tool adaption:	Universal arbor 27
	Gear ratio [i]:	4:1
	Torque max [Nm]:	64
	Rotation max [1/min]:	1000
	Rotating direction:	same
	Coolant:	EXT
	Please note:	stronger bearing
8 019 24 030	Axial milling head universal arbor 16	
	Notation:	offset
	Version:	right
	Tool drive:	DIN 5482
	Shank size [mm]:	30.00
	Shank type:	VDI
	Tool adaption:	Universal arbor 16
	Gear ratio [i]:	2:1
	Torque max [Nm]:	40
	Rotation max [1/min]:	3000
	Rotating direction:	opposite
	Coolant:	EXT
	Offset [mm]:	34,5
8 019 24 035	Axial drilling and milling head ER 20 IC	
	Notation:	offset
	Version:	right
	Tool drive:	DIN 5482
	Shank size [mm]:	30.00
	Shank type:	VDI
	Tool adaption:	ER 20
	Gear ratio [i]:	1:3
	Torque max [Nm]:	6
	Rotation max [1/min]:	15000
	Rotating direction:	opposite
	Coolant:	IC/Ext
	Pressure max [bar]:	25
	Offset [mm]:	34,5

Part-#	Name	
8 019 25 002	Axial drilling and milling head ER 25	
	Notation:	offset
	Version:	right
	Tool drive:	DIN 5482
	Shank size [mm]:	30.00
	Shank type:	VDI
	Tool adaption:	ER 25
	Gear ratio [i]:	1:1
	Torque max [Nm]:	16
	Rotation max [1/min]:	6000
	Rotating direction:	opposite
	Coolant:	EXT
	Offset [mm]:	34,5
8 019 25 013	Axial drilling and milling head ER 25	
	Notation:	offset
	Version:	right
	Tool drive:	DIN 5482
	Shank size [mm]:	30.00
	Shank type:	VDI
	Tool adaption:	ER 25
	Gear ratio [i]:	2:1
	Torque max [Nm]:	40
	Rotation max [1/min]:	3000
	Rotating direction:	opposite
	Coolant:	EXT
	Offset [mm]:	34,5
8 019 25 014	Axial drilling and milling head ER 25 IC	
	Weight [kg]:	4.060
	Notation:	offset
	Tool drive:	DIN 5482
	Shank size [mm]:	30.00
	Shank type:	VDI
	Tool adaption:	ER 25
	Gear ratio [i]:	2:1
	Torque max [Nm]:	40
	Rotation max [1/min]:	4000
	Rotating direction:	opposite
	Coolant:	IC/Ext
	Pressure max [bar]:	25
	Please note:	stronger bearing
	Offset [mm]:	34,5
8 019 25 015	Axial drilling and milling head ER 25 IC	
	Notation:	offset
	Version:	right
	Tool drive:	DIN 5482
	Shank size [mm]:	30.00
	Shank type:	VDI
	Tool adaption:	ER 25
	Gear ratio [i]:	1:1
	Torque max [Nm]:	16
	Rotation max [1/min]:	6000
	Rotating direction:	opposite
	Coolant:	IC/Ext
	Pressure max [bar]:	25
	Offset [mm]:	34,5

Part-#	Name	
8 019 25 019	Axial milling head universal arbor 22	
	Notation:	offset
	Version:	right
	Tool drive:	DIN 5482
	Shank size [mm]:	30.00
	Shank type:	VDI
	Tool adaption:	Universal arbor 22
	Gear ratio [i]:	2:1
	Torque max [Nm]:	40
	Rotation max [1/min]:	4000
	Rotating direction:	opposite
	Coolant:	EXT
	Please note:	stronger bearing
	Offset [mm]:	34,5
8 030 24 010	Radial drilling and milling head ER 20	
	Weight [kg]:	2.500
	Version:	right
	Tool drive:	DIN 5482
	Shank size [mm]:	30.00
	Shank type:	VDI
	Tool adaption:	ER 20
	Gear ratio [i]:	1:1
	Torque max [Nm]:	25
	Rotation max [1/min]:	6000
	Rotating direction:	opposite
	Coolant:	EXT
	Center distance [mm]:	54
8 030 24 026	Radial drilling and milling head ER 20 IC	
	Shank type:	VDI
	Tool adaption:	ER 20
	Gear ratio [i]:	1:1
	Coolant:	IC
	Please note:	IC for air
8 030 24 043	Radial drilling and milling head ER 20 IC	
	Weight [kg]:	2.760
	Version:	right
	Tool drive:	DIN 5482
	Shank size [mm]:	30.00
	Shank type:	VDI
	Tool adaption:	ER 20
	Gear ratio [i]:	1:1
	Torque max [Nm]:	25
	Rotation max [1/min]:	6000
	Rotating direction:	opposite
	Coolant:	IC/Ext
	Pressure max [bar]:	140
	Center distance [mm]:	54
8 030 24 104	Radial drilling and milling head ER 20	
	Tool drive:	DIN 5482
	Shank size [mm]:	30.00
	Shank type:	VDI
	Tool adaption:	ER 20
	Gear ratio [i]:	1:1
	Torque max [Nm]:	25

Part-#	Name	
	Rotation max [1/min]:	6000
	Rotating direction:	same
	Coolant:	EXT
	Please note:	stronger bearing
	Center distance [mm]:	54
8 030 25 001	Radial drilling and milling head ER 25	
	Weight [kg]:	2.550
	Version:	right
	Tool drive:	DIN 5482
	Shank size [mm]:	30.00
	Shank type:	VDI
	Tool adaption:	ER 25
	Gear ratio [i]:	1:1
	Torque max [Nm]:	25
	Rotation max [1/min]:	6000
	Rotating direction:	opposite
	Coolant:	EXT
	Center distance [mm]:	54
8 030 25 020	Radial drilling and milling head ER 25 IC	
	Weight [kg]:	2.950
	Version:	right
	Tool drive:	DIN 5482
	Shank size [mm]:	30.00
	Shank type:	VDI
	Tool adaption:	ER 25
	Gear ratio [i]:	1:1
	Torque max [Nm]:	25
	Rotation max [1/min]:	6000
	Rotating direction:	opposite
	Coolant:	IC/Ext
	Pressure max [bar]:	140
	Center distance [mm]:	54
8 030 25 043	Radial drilling and milling head Weldon 16 IC	
	Weight [kg]:	3.180
	Tool drive:	DIN 5482
	Shank size [mm]:	30.00
	Shank type:	VDI
	Tool adaption:	Weldon (DIN 1835 b) 16
	Gear ratio [i]:	1:1
	Torque max [Nm]:	16
	Rotation max [1/min]:	6000
	Rotating direction:	opposite
	Coolant:	IC/Ext
	Center distance [mm]:	54
8 030 25 044	Radial drilling and milling head ER 25	
	Weight [kg]:	3.420
	Version:	right
	Tool drive:	DIN 5482
	Shank size [mm]:	30.00
	Shank type:	VDI
	Tool adaption:	ER 25
	Gear ratio [i]:	2:1
	Torque max [Nm]:	32
	Rotation max [1/min]:	3000

Part-#	Name	
	Rotating direction:	opposite
	Coolant:	EXT
	Center distance [mm]:	66
8 030 25 110	Radial drilling and milling head ER 25 IC	
	Weight [kg]:	3.980
	Version:	right
	Tool drive:	DIN 5482
	Shank size [mm]:	30.00
	Shank type:	VDI
	Tool adaption:	ER 25
	Gear ratio [i]:	2:1
	Torque max [Nm]:	32
	Rotation max [1/min]:	3000
	Rotating direction:	opposite
	Coolant:	IC/Ext
	Pressure max [bar]:	25
	Center distance [mm]:	66
8 030 25 285	Radial drilling and milling head ER 25 AX UT	
	Weight [kg]:	2.760
	Version:	right
	Tool drive:	DIN 5482
	Shank size [mm]:	30.00
	Shank type:	VDI
	Tool adaption:	ER 25 A - u-tec
	Gear ratio [i]:	1:1
	Torque max [Nm]:	25
	Rotation max [1/min]:	6000
	Rotating direction:	opposite
	Coolant:	EXT
	Please note:	stronger bearing
	Center distance [mm]:	54
8 030 25 290	Radial drilling and milling head ER 25 AX UT IC	
	Weight [kg]:	2.980
	Version:	right
	Tool drive:	DIN 5482
	Shank size [mm]:	30.00
	Shank type:	VDI
	Tool adaption:	ER 25 A - u-tec
	Gear ratio [i]:	1:1
	Torque max [Nm]:	25
	Rotation max [1/min]:	6000
	Rotating direction:	opposite
	Coolant:	IC/Ext
	Pressure max [bar]:	140
	Center distance [mm]:	54
8 030 26 021	Radial drilling and milling head HT 4 IC	
	Weight [kg]:	2.910
	Version:	right
	Tool drive:	DIN 5482
	Shank size [mm]:	30.00
	Shank type:	VDI
	Tool adaption:	HT 4
	Gear ratio [i]:	1:1
	Torque max [Nm]:	25

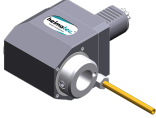
Part-#	Name	
	Rotation max [1/min]:	6000
	Rotating direction:	opposite
	Coolant:	IC/Ext
	Pressure max [bar]:	140
	Center distance [mm]:	54
8 030 26 027	Radial drilling and milling head HT 4	
	Weight [kg]:	2.520
	Tool drive:	DIN 5482
	Shank size [mm]:	30.00
	Shank type:	VDI
	Tool adaption:	HT 4
	Gear ratio [i]:	1:1
	Torque max [Nm]:	16
	Rotation max [1/min]:	6000
	Rotating direction:	opposite
	Coolant:	EXT
	Center distance [mm]:	54
8 030 26 136	Radial drilling and milling head ER 32 AX	
	Tool drive:	DIN 5482
	Shank size [mm]:	30.00
	Shank type:	VDI
	Tool adaption:	ER 32 A
	Gear ratio [i]:	2:1
	Torque max [Nm]:	32
	Rotation max [1/min]:	3000
	Rotating direction:	opposite
	Coolant:	EXT
	Please note:	stronger bearing
	Center distance [mm]:	66
8 030 26 158	Radial drilling and milling head ER 32 IC	
	Version:	right
	Tool drive:	DIN 5482
	Shank size [mm]:	30.00
	Shank type:	VDI
	Tool adaption:	ER 32
	Gear ratio [i]:	1:1
	Torque max [Nm]:	25
	Rotation max [1/min]:	6000
	Rotating direction:	opposite
	Coolant:	IC/Ext
	Pressure max [bar]:	140
	Please note:	stronger bearing
	Center distance [mm]:	54
8 031 24 009	Radial milling head universal arbor 16	
	Weight [kg]:	2.520
	Version:	right
	Tool drive:	DIN 5482
	Shank size [mm]:	30.00
	Shank type:	VDI
	Tool adaption:	Universal arbor 16
	Gear ratio [i]:	1:1
	Torque max [Nm]:	25
	Rotation max [1/min]:	6000

Part-#	Name	
	Rotating direction:	opposite
	Coolant:	EXT
	Center distance [mm]:	54
8 031 25 000	Radial milling head universal arbor 22	
	Weight [kg]:	3.040
	Tool drive:	DIN 5482
	Shank size [mm]:	30.00
	Shank type:	VDI
	Tool adaption:	Universal arbor 22
	Gear ratio [i]:	1:1
	Torque max [Nm]:	25
	Rotation max [1/min]:	6000
	Rotating direction:	opposite
	Coolant:	EXT
	Please note:	stronger bearing
	Center distance [mm]:	54
8 031 25 003	Radial milling head universal arbor 22	
	Weight [kg]:	3.900
	Version:	right
	Tool drive:	DIN 5482
	Shank size [mm]:	30.00
	Shank type:	VDI
	Tool adaption:	Universal arbor 22
	Gear ratio [i]:	2:1
	Torque max [Nm]:	32
	Rotation max [1/min]:	3000
	Rotating direction:	opposite
	Coolant:	EXT
	Please note:	stronger bearing
	Center distance [mm]:	66
8 033 24 006	Radial drilling and milling head ER 20	
	Weight [kg]:	3.560
	Notation:	offset
	Tool drive:	DIN 5482
	Shank size [mm]:	30.00
	Shank type:	VDI
	Tool adaption:	ER 20
	Gear ratio [i]:	1:1
	Torque max [Nm]:	16
	Rotation max [1/min]:	6000
	Rotating direction:	same
	Coolant:	EXT
	Center distance [mm]:	75
8 033 24 010	Radial drilling and milling head ER 20 IC	
	Weight [kg]:	4.000
	Notation:	offset
	Tool drive:	DIN 5482
	Shank size [mm]:	30.00
	Shank type:	VDI
	Tool adaption:	ER 20
	Gear ratio [i]:	1:1
	Torque max [Nm]:	25
	Rotation max [1/min]:	8000
	Rotating direction:	same

Part-#	Name	
	Coolant:	IC/Ext
	Pressure max [bar]:	140
	Please note:	High pressure version
	Center distance [mm]:	75
	Offset [mm]:	34,5
8 033 25 001	Radial drilling and milling head ER 25	
	Weight [kg]:	3.640
	Notation:	offset
	Version:	right
	Tool drive:	DIN 5482
	Shank size [mm]:	30.00
	Shank type:	VDI
	Tool adaption:	ER 25
	Gear ratio [i]:	1:1
	Torque max [Nm]:	25
	Rotation max [1/min]:	6000
	Rotating direction:	same
	Coolant:	EXT
	Center distance [mm]:	75
	Offset [mm]:	34,5
8 033 25 003	Radial drilling and milling head ER 25 IC air	
	Weight [kg]:	4.120
	Notation:	offset
	Version:	right
	Tool drive:	DIN 5482
	Shank size [mm]:	30.00
	Shank type:	VDI
	Tool adaption:	ER 25
	Gear ratio [i]:	1:1
	Torque max [Nm]:	16
	Rotation max [1/min]:	6000
	Rotating direction:	same
	Coolant:	IC air
	Pressure max [bar]:	10
	Center distance [mm]:	75
8 033 25 009	Radial drilling and milling head ER 25 IC	
	Weight [kg]:	3.960
	Notation:	offset
	Version:	right
	Tool drive:	DIN 5482
	Shank size [mm]:	30.00
	Shank type:	VDI
	Tool adaption:	ER 25
	Gear ratio [i]:	1:1
	Torque max [Nm]:	25
	Rotation max [1/min]:	6000
	Rotating direction:	same
	Coolant:	IC/Ext
	Pressure max [bar]:	140
	Center distance [mm]:	75
	Offset [mm]:	34,5

Part-#	Name	
8 033 25 011	Radial drilling and milling head ER 25	
	Weight [kg]:	4.540
	Tool drive:	DIN 5482
	Shank size [mm]:	30.00
	Shank type:	VDI
	Tool adaption:	ER 25
	Gear ratio [i]:	2:1
	Torque max [Nm]:	32
	Rotation max [1/min]:	3000
	Rotating direction:	same
	Coolant:	EXT
8 033 25 021	Radial drilling and milling head ER 25 IC	
	Notation:	offset
	Version:	right
	Tool drive:	DIN 5482
	Shank size [mm]:	30.00
	Shank type:	VDI
	Tool adaption:	ER 25
	Gear ratio [i]:	2:1
	Torque max [Nm]:	32
	Rotation max [1/min]:	3000
	Rotating direction:	same
	Coolant:	IC/Ext
	Pressure max [bar]:	25
	Center distance [mm]:	87
8 033 25 087	Radial drilling and milling head ER 25 AX UT	
	Weight [kg]:	3.870
	Notation:	offset
	Version:	right
	Tool drive:	DIN 5482
	Shank size [mm]:	30.00
	Shank type:	VDI
	Tool adaption:	ER 25 A - u-tec
	Gear ratio [i]:	1:1
	Torque max [Nm]:	25
	Rotation max [1/min]:	6000
	Rotating direction:	same
	Coolant:	EXT
	Please note:	stronger bearing
	Center distance [mm]:	75
8 033 26 000	Radial drilling and milling head ER 32	
	Weight [kg]:	6.460
	Notation:	offset
	Tool drive:	DIN 5482
	Shank size [mm]:	30.00
	Shank type:	VDI
	Tool adaption:	ER 32
	Gear ratio [i]:	3,012:1
	Torque max [Nm]:	50
	Rotation max [1/min]:	2000
	Rotating direction:	same
	Coolant:	EXT

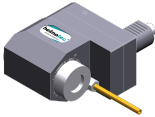
Part-#	Name	
8 033 26 006	Radial drilling and milling head ER 32 IC	
	Notation:	offset
	Version:	right
	Tool drive:	DIN 5482
	Shank size [mm]:	30.00
	Shank type:	VDI
	Tool adaption:	ER 32
	Gear ratio [i]:	1:1
	Torque max [Nm]:	25
	Rotation max [1/min]:	6000
	Rotating direction:	same
	Coolant:	IC/Ext
	Pressure max [bar]:	25
	Please note:	stronger bearing
	Center distance [mm]:	75
8 033 26 029	Radial drilling and milling head HT 4	
	Weight [kg]:	3.630
	Notation:	offset
	Version:	right
	Tool drive:	DIN 5482
	Shank size [mm]:	30.00
	Shank type:	VDI
	Tool adaption:	HT 4
	Gear ratio [i]:	1:1
	Torque max [Nm]:	25
	Rotation max [1/min]:	6000
	Rotating direction:	same
	Coolant:	EXT
	Center distance [mm]:	75
8 033 26 032	Radial drilling and milling head HT 4 IC	
	Weight [kg]:	4.010
	Notation:	offset
	Version:	right
	Tool drive:	DIN 5482
	Shank size [mm]:	30.00
	Shank type:	VDI
	Tool adaption:	HT 4
	Gear ratio [i]:	1:1
	Torque max [Nm]:	25
	Rotation max [1/min]:	6000
	Rotating direction:	same
	Coolant:	IC/Ext
	Pressure max [bar]:	140
	Center distance [mm]:	75
	Offset [mm]:	34,5
8 033 26 068	Radial drilling and milling head ER 32	
	Weight [kg]:	4.220
	Notation:	offset
	Version:	right
	Tool drive:	DIN 5482
	Shank size [mm]:	30.00
	Shank type:	VDI
	Tool adaption:	ER 32
	Gear ratio [i]:	1:1
	Torque max [Nm]:	25

Part-#	Name	
	Rotation max [1/min]:	6000
	Rotating direction:	same
	Coolant:	EXT
	Please note:	stronger bearing
	Center distance [mm]:	75
8 033 27 000	Radial drilling and milling head Weldon 1" IC	
	Version:	Special
	Tool drive:	DIN 5482
	Shank size [mm]:	30.00
	Shank type:	VDI
	Tool adaption:	Weldon (DIN 1835 b) 1" (25,4mm)
	Gear ratio [i]:	3:1
	Torque max [Nm]:	50
	Rotation max [1/min]:	2000
	Rotating direction:	same
	Coolant:	IC/Ext
8 034 24 009	Radial milling head universal arbor 16	
	Weight [kg]:	4.820
	Notation:	offset
	Version:	right
	Tool drive:	DIN 5482
	Shank size [mm]:	30.00
	Shank type:	VDI
	Tool adaption:	Universal arbor 16
	Gear ratio [i]:	2:1
	Torque max [Nm]:	32
	Rotation max [1/min]:	3000
	Rotating direction:	same
	Coolant:	EXT
	Center distance [mm]:	87
8 034 25 003	Radial milling head universal arbor 22	
	Tool drive:	DIN 5482
	Shank size [mm]:	30.00
	Shank type:	VDI
	Tool adaption:	Universal arbor 22
	Gear ratio [i]:	1:1
	Torque max [Nm]:	16
	Rotation max [1/min]:	6000
	Rotating direction:	same
	Coolant:	EXT
	Please note:	stronger bearing
8 037 29 023	Radial disk mill head shaft diameter 10-22	
	Weight [kg]:	9.280
	Tool drive:	DIN 5482
	Shank size [mm]:	30.00
	Shank type:	VDI
	Tool adaption:	Interchangeable arbor
	Gear ratio [i]:	3:1
	Torque max [Nm]:	50
	Rotation max [1/min]:	2000
	Rotating direction:	opposite
	Coolant:	EXT
	Please note:	Price without arbor

Part-#	Name	
8 037 29 024	Radial disk mill head shaft diameter 10-22	
	Tool drive:	DIN 5482
	Shank size [mm]:	30.00
	Shank type:	VDI
	Tool adaption:	Interchangeable arbor
	Gear ratio [i]:	3:1
	Torque max [Nm]:	50
	Rotation max [1/min]:	2000
	Rotating direction:	opposite
	Coolant:	EXT
	Please note:	Price without arbor
8 037 29 025	Radial disk mill head shaft diameter 10-22	
	Tool drive:	DIN 5482
	Shank size [mm]:	30.00
	Shank type:	VDI
	Tool adaption:	Interchangeable arbor
	Gear ratio [i]:	3:1
	Torque max [Nm]:	50
	Rotation max [1/min]:	2000
	Rotating direction:	opposite
	Coolant:	EXT
	Please note:	Price without arbor
8 037 29 034	Radial disk mill head shaft diameter 10-22	
	Weight [kg]:	9.280
	Tool drive:	DIN 5482
	Shank size [mm]:	30.00
	Shank type:	VDI
	Tool adaption:	Interchangeable arbor
	Gear ratio [i]:	3:1
	Torque max [Nm]:	50
	Rotation max [1/min]:	2000
	Rotating direction:	opposite
	Coolant:	EXT
	Please note:	Price without arbor
8 038 24 004	Radial drilling and milling head ER 20	
	Weight [kg]:	4.200
	Notation:	Y-axes adjustable
	Tool drive:	DIN 5482
	Shank size [mm]:	30.00
	Shank type:	VDI
	Tool adaption:	ER 20
	Gear ratio [i]:	1:1
	Torque max [Nm]:	16
	Rotation max [1/min]:	6000
	Rotating direction:	same
	Coolant:	EXT
8 038 24 005	Radial drilling and milling head ER 20	
	Tool drive:	DIN 5482
	Shank size [mm]:	30.00
	Shank type:	VDI
	Tool adaption:	ER 20
	Gear ratio [i]:	1:1
	Torque max [Nm]:	16
	Rotation max [1/min]:	5000

Part-#	Name	
	Rotating direction:	opposite
	Coolant:	EXT
	Please note:	Special version
8 038 25 000	Radial drilling and milling head ER 25	
	Weight [kg]:	4.260
	Notation:	Y-axes adjustable
	Version:	right
	Tool drive:	DIN 5482
	Shank size [mm]:	30.00
	Shank type:	VDI
	Tool adaption:	ER 25
	Gear ratio [i]:	1:1
	Torque max [Nm]:	16
	Rotation max [1/min]:	5000
	Rotating direction:	same
	Coolant:	EXT
8 038 25 003	Radial drilling and milling head ER 25	
	Notation:	Y-axes adjustable
	Tool drive:	DIN 5482
	Shank size [mm]:	30.00
	Shank type:	VDI
	Tool adaption:	ER 25
	Gear ratio [i]:	1:1
	Torque max [Nm]:	16
	Rotation max [1/min]:	5000
	Rotating direction:	same
	Coolant:	EXT
8 039 24 010	Radial drilling and milling head ER 20 AX	
	Weight [kg]:	5.360
	Notation:	135° angle
	Version:	Special
	Tool drive:	DIN 5482
	Shank size [mm]:	30.00
	Shank type:	VDI
	Tool adaption:	ER 20 A
	Gear ratio [i]:	1:1
	Torque max [Nm]:	16
	Rotation max [1/min]:	6000
	Rotating direction:	opposite
	Coolant:	EXT
8 040 25 027	Universal head ± 90° adjustable ER 25 AX UT	
	Tool drive:	DIN 5482
	Shank size [mm]:	30.00
	Shank type:	VDI
	Tool adaption:	ER 25 A - u-tec
	Gear ratio [i]:	1:1
	Torque max [Nm]:	25
	Rotation max [1/min]:	6000
	Rotating direction:	opposite
	Coolant:	EXT
	Please note:	stronger bearing
	Center distance [mm]:	87

Goodway

GA 230 LM - VDI 30 DIN 5482

heimatec®

Part-#	Name
8 210 26 011	Tool holder HT 4 IC
	Weight [kg]: 1.270
	Version: right
	Shank size [mm]: 30.00
	Shank type: VDI
	Tool adaption: HT 4
	Coolant: IC/Ext

heimatec.u-tec®

heimatec.com

Products / Tool change systems /
u-tec® Tool-changing system



versions see catalog



heimatec.easy-quick

heimatec.com

Products / Tool change systems /
easy-quick HT quick-changing system



versions see catalog



heimatec.Capto™

heimatec.com

Products / Tool change systems /
heimatec.Capto™ quick-changing system



versions see catalog

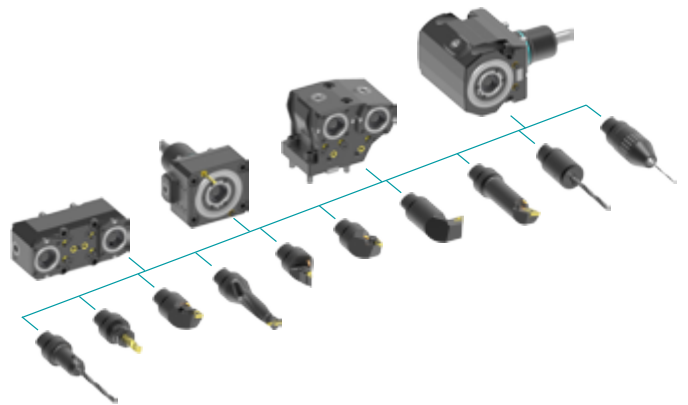

heimatec.accessories

heimatec.com

Products / Accessories



versions see catalog





● heimatec overseas branches

○ global representations of heimatec

heimatec[®]

heimatec GmbH
Präzisionswerkzeuge
Carl-Benz-Str. 4
77871 Renchen
Germany

T +49 7843 9466 0
www.heimatec.com
info@heimatec.com

Please find the contact details of our worldwide trading partners on our website:
<https://heimatec.com/business-partners>