

DMG MORI
ecoTurn 310



High-tech from heimatec - heimatec - Tools and systems for productive turning and milling

heimatec belongs to the international technology and quality leaders for precision tools and specializes in the development and production of high-precision static and live tools for all CNC lathes, CNC turn-/mill machines and CNC machining centers.

The range of products* spans from static BMT and VDI tool holders, live tools up to highly complex customer-specific individual solutions. heimatec, headquartered in Renchen, has a own subsidiary in Asia and India and numerous representatives as well as trading partners all over the world.

*OUR PRODCUTS

Static tool holders

Live tool units

Precision tools

Tools for turning and machining centres

Tools for swiss type lathes

Tool changing and uick-change systems





Tool systems for gear production

Digital tool management

This catalogue, including all its parts, is protected by copyright. Any use outside the restricted limitations of the Copyright Act without the consent of heimatec is inadmissible and liable to prosecution. This applies in particular to duplication, translation, microfilming and storage and processing in electronic systems.

heimatec GmbH reserves the right to make technical changes at any time without giving prior notice. This applies in particular to adjustments at any time to meet new or changed international standards, or in case of further developments of our products or manufacturing processes.

The current version of our General Terms and Conditions can be found on our website.

| Part-# | Name | |
|---|---|--------------------|
| 8 010 25 090 | Axial drilling and milling head ER 25 | |
|  | Weight [kg]: | 1.580 |
| | Tool drive: | DIN 5480 |
| | Shank size [mm]: | 30.00 |
| | Shank type: | VDI |
| | Tool adaption: | ER 25 |
| | Gear ratio [i]: | 1:1 |
| | Torque max [Nm]: | 25 |
| | Rotation max [1/min]: | 6000 |
| | Rotating direction: | same |
| | Coolant: | EXT |
| | Please note: | round housing ø 68 |
| 8 010 25 091 | Axial drilling and milling head ER 25 IC | |
|  | Weight [kg]: | 1.830 |
| | Tool drive: | DIN 5480 |
| | Shank size [mm]: | 30.00 |
| | Shank type: | VDI |
| | Tool adaption: | ER 25 |
| | Gear ratio [i]: | 1:1 |
| | Torque max [Nm]: | 25 |
| | Rotation max [1/min]: | 6000 |
| | Rotating direction: | same |
| | Coolant: | IC/Ext |
| | Pressure max [bar]: | 25 |
| | Please note: | round housing ø 68 |
| 8 010 25 118 | Axial drilling and milling head ER 25 AX UT | |
|  | Weight [kg]: | 1.780 |
| | Tool drive: | DIN 5480 |
| | Shank size [mm]: | 30.00 |
| | Shank type: | VDI |
| | Tool adaption: | ER 25 A - u-tec |
| | Gear ratio [i]: | 1:1 |
| | Torque max [Nm]: | 25 |
| | Rotation max [1/min]: | 12000 |
| | Rotating direction: | same |
| | Coolant: | EXT |
| | Please note: | stronger bearing |
| 8 010 25 119 | Axial drilling and milling head ER 25 AX UT IC | |
|  | Weight [kg]: | 1.780 |
| | Tool drive: | DIN 5480 |
| | Shank size [mm]: | 30.00 |
| | Shank type: | VDI |
| | Tool adaption: | ER 25 A - u-tec |
| | Gear ratio [i]: | 1:1 |
| | Torque max [Nm]: | 25 |
| | Rotation max [1/min]: | 6000 |
| | Rotating direction: | same |
| | Coolant: | IC/Ext |
| | Pressure max [bar]: | 25 |
| | Please note: | round housing ø 68 |

| Part-# | Name | |
|---------------------|---|----------|
| 8 030 25 021 | Radial drilling and milling head ER 25 | |
| | Weight [kg]: | 3.970 |
| | Version: | right |
| | Tool drive: | DIN 5480 |
| | Shank size [mm]: | 30.00 |
| | Shank type: | VDI |
| | Tool adaption: | ER 25 |
| | Gear ratio [i]: | 1:1 |
| | Torque max [Nm]: | 25 |
| | Rotation max [1/min]: | 6000 |
| | Rotating direction: | opposite |
| | Coolant: | EXT |
| | Center distance [mm]: | 100 |
| 8 030 25 050 | Radial drilling and milling head ER 25 | |
| | Weight [kg]: | 2.660 |
| | Version: | right |
| | Tool drive: | DIN 5480 |
| | Shank size [mm]: | 30.00 |
| | Shank type: | VDI |
| | Tool adaption: | ER 25 |
| | Gear ratio [i]: | 1:1 |
| | Torque max [Nm]: | 16 |
| | Rotation max [1/min]: | 6000 |
| | Rotating direction: | opposite |
| | Coolant: | EXT |
| | Center distance [mm]: | 55 |
| 8 030 25 055 | Radial drilling and milling head ER 25 | |
| | Weight [kg]: | 4.020 |
| | Version: | left |
| | Tool drive: | DIN 5480 |
| | Shank size [mm]: | 30.00 |
| | Shank type: | VDI |
| | Tool adaption: | ER 25 |
| | Gear ratio [i]: | 1:1 |
| | Torque max [Nm]: | 25 |
| | Rotation max [1/min]: | 6000 |
| | Rotating direction: | opposite |
| | Coolant: | EXT |
| | Center distance [mm]: | 100 |
| 8 030 25 113 | Radial drilling and milling head ER 25 | |
| | Weight [kg]: | 4.440 |
| | Version: | right |
| | Tool drive: | DIN 5480 |
| | Shank size [mm]: | 30.00 |
| | Shank type: | VDI |
| | Tool adaption: | ER 25 |
| | Gear ratio [i]: | 1:2 |
| | Torque max [Nm]: | 16 |
| | Rotation max [1/min]: | 12000 |
| | Rotating direction: | opposite |
| | Coolant: | EXT |
| | Center distance [mm]: | 85 |

| Part-# | Name | |
|---------------------|--|------------------|
| 8 030 25 242 | Radial drilling and milling head ER 25 AX UT | |
| | Weight [kg]: | 3.760 |
| | Version: | right |
| | Tool drive: | DIN 5480 |
| | Shank size [mm]: | 30.00 |
| | Shank type: | VDI |
| | Tool adaption: | ER 25 A - u-tec |
| | Gear ratio [i]: | 1:1 |
| | Torque max [Nm]: | 25 |
| | Rotation max [1/min]: | 6000 |
| | Rotating direction: | opposite |
| | Coolant: | EXT |
| | Please note: | stronger bearing |
| | Center distance [mm]: | 85 |
| 8 030 25 267 | Radial drilling and milling head ER 25 AX UT IC | |
| | Weight [kg]: | 4.150 |
| | Version: | right |
| | Tool drive: | DIN 5480 |
| | Shank size [mm]: | 30.00 |
| | Shank type: | VDI |
| | Tool adaption: | ER 25 A - u-tec |
| | Gear ratio [i]: | 1:1 |
| | Torque max [Nm]: | 25 |
| | Rotation max [1/min]: | 6000 |
| | Rotating direction: | opposite |
| | Coolant: | IC/Ext |
| | Pressure max [bar]: | 140 |
| | Please note: | stronger bearing |
| | Center distance [mm]: | 85 |
| 8 030 25 277 | Radial drilling and milling head ER 25 IC | |
| | Weight [kg]: | 3.310 |
| | Version: | right |
| | Tool drive: | DIN 5480 |
| | Shank size [mm]: | 30.00 |
| | Shank type: | VDI |
| | Tool adaption: | ER 25 |
| | Gear ratio [i]: | 1:1 |
| | Torque max [Nm]: | 25 |
| | Rotation max [1/min]: | 6000 |
| | Rotating direction: | opposite |
| | Coolant: | IC/Ext |
| | Pressure max [bar]: | 140 |
| | Center distance [mm]: | 64 |
| 8 030 25 280 | Radial drilling and milling head ER 25 AX UT | |
| | Weight [kg]: | 3.200 |
| | Version: | right |
| | Tool drive: | DIN 5480 |
| | Shank size [mm]: | 30.00 |
| | Shank type: | VDI |
| | Tool adaption: | ER 25 A - u-tec |
| | Gear ratio [i]: | 1:1 |
| | Torque max [Nm]: | 25 |
| | Rotation max [1/min]: | 6000 |
| | Rotating direction: | opposite |
| | Coolant: | EXT |

| Part-# | Name | |
|---------------------|--|--------------------|
| | Please note: | stronger bearing |
| | Center distance [mm]: | 64 |
| 8 031 24 046 | Radial milling head universal arbor 16 | |
| | Weight [kg]: | 3.220 |
| | Version: | right |
| | Tool drive: | DIN 5480 |
| | Shank size [mm]: | 30.00 |
| | Shank type: | VDI |
| | Tool adaption: | Universal arbor 16 |
| | Gear ratio [i]: | 1:1 |
| | Torque max [Nm]: | 25 |
| | Rotation max [1/min]: | 6000 |
| | Rotating direction: | opposite |
| | Coolant: | EXT |
| | Please note: | Combi bearing |
| | Center distance [mm]: | 64 |
| 8 033 25 032 | Radial drilling and milling head ER 25 IC | |
| | Weight [kg]: | 4.020 |
| | Version: | right |
| | Tool drive: | DIN 5480 |
| | Shank size [mm]: | 30.00 |
| | Shank type: | VDI |
| | Tool adaption: | ER 25 |
| | Gear ratio [i]: | 1:1 |
| | Torque max [Nm]: | 25 |
| | Rotation max [1/min]: | 6000 |
| | Rotating direction: | same |
| | Coolant: | IC/Ext |
| | Pressure max [bar]: | 140 |
| | Center distance [mm]: | 85 |
| 8 033 25 069 | Radial drilling and milling head ER 25 | |
| | Notation: | offset |
| | Version: | right |
| | Tool drive: | DIN 5480 |
| | Shank size [mm]: | 30.00 |
| | Shank type: | VDI |
| | Tool adaption: | ER 25 |
| | Gear ratio [i]: | 2:1 |
| | Torque max [Nm]: | 32 |
| | Rotation max [1/min]: | 3000 |
| | Rotating direction: | same |
| | Coolant: | EXT |
| | Please note: | stronger bearing |
| | Center distance [mm]: | 97 |
| | Offset [mm]: | 34,5 |
| 8 036 25 003 | Radial drilling and milling head ER 25 | |
| | Weight [kg]: | 3.990 |
| | Version: | doubletoothed |
| | Tool drive: | DIN 5480 |
| | Shank size [mm]: | 30.00 |
| | Shank type: | VDI |
| | Tool adaption: | ER 25 |
| | Gear ratio [i]: | 1:1 |
| | Torque max [Nm]: | 25 |

| Part-# | Name | |
|---------------------|--|--------------------------|
| | Rotation max [1/min]: | 6000 |
| | Rotating direction: | opposite |
| | Coolant: | EXT |
| | Center distance [mm]: | 100 |
| 8 036 25 041 | Radial drilling and milling head ER 25 AX UT | |
| | Weight [kg]: | 4.220 |
| | Notation: | 180° reversible |
| | Version: | doubletoothed |
| | Tool drive: | DIN 5480 |
| | Shank size [mm]: | 30.00 |
| | Shank type: | VDI |
| | Tool adaption: | ER 25 A - u-tec |
| | Gear ratio [i]: | 1:1 |
| | Torque max [Nm]: | 25 |
| | Rotation max [1/min]: | 6000 |
| | Rotating direction: | opposite |
| | Coolant: | EXT |
| | Please note: | stronger bearing |
| | Center distance [mm]: | 100 |
| 8 036 25 042 | Radial drilling and milling head ER 25 AX UT IC | |
| | Weight [kg]: | 4.640 |
| | Notation: | 180° reversible |
| | Version: | doubletoothed |
| | Tool drive: | DIN 5480 |
| | Shank size [mm]: | 30.00 |
| | Shank type: | VDI |
| | Tool adaption: | ER 25 A - u-tec |
| | Gear ratio [i]: | 1:1 |
| | Torque max [Nm]: | 25 |
| | Rotation max [1/min]: | 6000 |
| | Rotating direction: | opposite |
| | Coolant: | IC/Ext |
| | Pressure max [bar]: | 140 |
| | Please note: | stronger bearing |
| | Center distance [mm]: | 100 |
| 8 040 24 012 | Universal head ± 90° adjustable ER 20 | |
| | Weight [kg]: | 2.470 |
| | Version: | right |
| | Tool drive: | DIN 5480 |
| | Shank size [mm]: | 30.00 |
| | Shank type: | VDI |
| | Tool adaption: | ER 20 |
| | Gear ratio [i]: | 1:1 |
| | Torque max [Nm]: | 10 |
| | Rotation max [1/min]: | 6000 |
| | Rotating direction: | same |
| | Coolant: | EXT |
| | Please note: | Fixation 180° reversible |
| | Center distance [mm]: | 64 |

| Part-# | Name | |
|---------------------|---|--------------------------|
| 8 040 24 032 | Universal head ± 90° adjustable HT 2 | |
| | Weight [kg]: | 3.080 |
| | Version: | doubletoothed |
| | Tool drive: | DIN 5480 |
| | Shank size [mm]: | 30.00 |
| | Shank type: | VDI |
| | Tool adaption: | HT 2 |
| | Gear ratio [i]: | 1:1 |
| | Torque max [Nm]: | 10 |
| | Rotation max [1/min]: | 5000 |
| | Rotating direction: | same |
| | Coolant: | EXT |
| | Please note: | Note swivel range |
| | Center distance [mm]: | 97 |
| 8 040 24 035 | Universal head ± 90° adjustable ER 16 | |
| | Weight [kg]: | 2.320 |
| | Version: | right |
| | Tool drive: | DIN 5480 |
| | Shank size [mm]: | 30.00 |
| | Shank type: | VDI |
| | Tool adaption: | ER 16 |
| | Gear ratio [i]: | 1:1 |
| | Torque max [Nm]: | 10 |
| | Rotation max [1/min]: | 6000 |
| | Rotating direction: | same |
| | Coolant: | EXT |
| | Please note: | Fixation 180° reversible |
| | Center distance [mm]: | 64 |
| 8 040 24 075 | Universal head ± 90° adjustable ER 16 AX UT IC | |
| | Weight [kg]: | 4.450 |
| | Version: | left |
| | Tool drive: | DIN 5480 |
| | Shank size [mm]: | 30.00 |
| | Shank type: | VDI |
| | Tool adaption: | ER 16 A - u-tec |
| | Gear ratio [i]: | 1:1 |
| | Torque max [Nm]: | 25 |
| | Rotation max [1/min]: | 6000 |
| | Rotating direction: | opposite |
| | Coolant: | IC/Ext |
| | Pressure max [bar]: | 140 |
| | Center distance [mm]: | 88 |
| 8 040 25 022 | Universal head ± 90° adjustable ER 25 AX UT IC | |
| | Weight [kg]: | 4.650 |
| | Version: | left |
| | Tool drive: | DIN 5480 |
| | Shank size [mm]: | 30.00 |
| | Shank type: | VDI |
| | Tool adaption: | ER 25 A - u-tec |
| | Gear ratio [i]: | 1:1 |
| | Torque max [Nm]: | 25 |
| | Rotation max [1/min]: | 6000 |
| | Rotating direction: | opposite |
| | Coolant: | IC/Ext |
| | Pressure max [bar]: | 140 |

| Part-# | Name | |
|---------------------|---|------------------|
| | Please note: | stronger bearing |
| | Center distance [mm]: | 88 |
| 8 040 25 032 | Universal head ± 90° adjustable ER 25 AX UT | |
| | Weight [kg]: | 4.660 |
| | Version: | right |
| | Tool drive: | DIN 5480 |
| | Shank size [mm]: | 30.00 |
| | Shank type: | VDI |
| | Tool adaption: | ER 25 A - u-tec |
| | Gear ratio [i]: | 1:1 |
| | Torque max [Nm]: | 25 |
| | Rotation max [1/min]: | 6000 |
| | Rotating direction: | opposite |
| | Coolant: | EXT |
| | Please note: | stronger bearing |
| | Center distance [mm]: | 88 |
| 8 040 25 038 | Universal head ± 90° adjustable ER 25 AX UT | |
| | Weight [kg]: | 4.890 |
| | Version: | right |
| | Tool drive: | DIN 5480 |
| | Shank size [mm]: | 30.00 |
| | Shank type: | VDI |
| | Tool adaption: | ER 25 A - u-tec |
| | Gear ratio [i]: | 1:1 |
| | Torque max [Nm]: | 25 |
| | Rotation max [1/min]: | 6000 |
| | Rotating direction: | opposite |
| | Coolant: | EXT |
| | Please note: | stronger bearing |
| | Center distance [mm]: | 88 |
| 8 040 25 040 | Universal head ± 90° adjustable ER 25 AX UT IC | |
| | Weight [kg]: | 3.500 |
| | Version: | right |
| | Tool drive: | DIN 5480 |
| | Shank size [mm]: | 30.00 |
| | Shank type: | VDI |
| | Tool adaption: | ER 25 A - u-tec |
| | Gear ratio [i]: | 1:1 |
| | Torque max [Nm]: | 25 |
| | Rotation max [1/min]: | 6000 |
| | Rotating direction: | opposite |
| | Coolant: | IC/Ext |
| | Pressure max [bar]: | 140 |
| | Please note: | stronger bearing |
| | Center distance [mm]: | 88 |
| 8 200 20 000 | Plug Z2-30 K | |
| | Weight [kg]: | 0.060 |
| | Shank size [mm]: | 30.00 |
| | Shank type: | VDI |
| 8 200 20 002 | Tool holder A2-30x100 | |
| | Weight [kg]: | 3.120 |
| | Shank size [mm]: | 30.00 |
| | Shank type: | VDI |

| Part-# | Name | |
|--------------|---|------------------|
| 8 200 20 005 | Plug Z2-30 S | |
| | Weight [kg]: | 0.740 |
| | Shank size [mm]: | 30.00 |
| | Shank type: | VDI |
| 8 200 20 008 | Tool holder A2-30x240 | |
| | Weight [kg]: | 7.160 |
| | Shank size [mm]: | 30.00 |
| | Shank type: | VDI |
| 8 200 23 000 | Tool holder A1-30x 85 | |
| | Weight [kg]: | 6.900 |
| | Shank size [mm]: | 30.00 |
| | Shank type: | VDI |
| 8 202 23 000 | Basic holder transversal set SZ 40 | |
| | Weight [kg]: | 0.890 |
| | Shank size [mm]: | 30.00 |
| | Shank type: | VDI |
| | Tool adaption: | Interface SZ 40 |
| | Coolant: | EXT |
| 8 210 21 000 | Tool holder F 30-MK 1 | |
| | Weight [kg]: | 0.960 |
| | Shank size [mm]: | 30.00 |
| | Shank type: | VDI |
| | Tool adaption: | DIN 228 D - MK 1 |
| | Coolant: | IC |
| 8 210 22 000 | Tool holder F 30-MK 2 | |
| | Weight [kg]: | 0.880 |
| | Shank size [mm]: | 30.00 |
| | Shank type: | VDI |
| | Tool adaption: | DIN 228 D - MK 2 |
| | Coolant: | IC |
| 8 210 22 002 | Tool holder E2-30x 6 | |
| | Shank size [mm]: | 30.00 |
| | Shank type: | VDI |
| | Tool adaption: | Ø 6 |
| | Coolant: | IC/Ext |
| 8 210 23 000 | Tool holder F 30-MK 3 | |
| | Weight [kg]: | 1.340 |
| | Shank size [mm]: | 30.00 |
| | Shank type: | VDI |
| | Tool adaption: | DIN 228 D - MK 3 |
| | Coolant: | IC |
| 8 210 23 001 | Tool holder E2-30x 8 | |
| | Shank size [mm]: | 30.00 |
| | Shank type: | VDI |
| | Tool adaption: | Ø 8 |
| | Coolant: | IC/Ext |

| Part-# | Name | |
|---------------------|---|--------|
| 8 210 23 007 | Short drill chuck VDI 30x 8 | |
| | Weight [kg]: | 0.940 |
| | Shank size [mm]: | 30.00 |
| | Shank type: | VDI |
| | Coolant: | EXT |
| 8 210 23 009 | Short drill chuck VDI 30x 8 - IC | |
| | Weight [kg]: | 1.000 |
| | Shank size [mm]: | 30.00 |
| | Shank type: | VDI |
| | Coolant: | IC |
| 8 210 24 002 | Tool holder E2-30x12 | |
| | Shank size [mm]: | 30.00 |
| | Shank type: | VDI |
| | Tool adaption: | Ø 12 |
| | Coolant: | IC/Ext |
| 8 210 24 003 | Short drill chuck VDI 30x13 | |
| | Weight [kg]: | 2.100 |
| | Shank size [mm]: | 30.00 |
| | Shank type: | VDI |
| | Coolant: | EXT |
| 8 210 24 010 | Tool holder E1-30x10 | |
| | Shank size [mm]: | 30.00 |
| | Shank type: | VDI |
| | Tool adaption: | Ø 10 |
| | Coolant: | IC |
| 8 210 24 011 | Tool holder E1-30x12 | |
| | Shank size [mm]: | 30.00 |
| | Shank type: | VDI |
| | Tool adaption: | Ø 12 |
| | Coolant: | IC |
| 8 210 24 014 | Short drill chuck VDI 30x13 - IC | |
| | Weight [kg]: | 1.820 |
| | Shank size [mm]: | 30.00 |
| | Shank type: | VDI |
| | Coolant: | IC |
| 8 210 24 015 | Tool holder E1-30x14 | |
| | Shank size [mm]: | 30.00 |
| | Shank type: | VDI |
| | Tool adaption: | Ø 14 |
| | Coolant: | IC |
| 8 210 24 021 | Tool holder E2-30x14 | |
| | Shank size [mm]: | 30.00 |
| | Shank type: | VDI |
| | Tool adaption: | Ø 14 |
| | Coolant: | IC/Ext |

| Part-# | Name | |
|---------------------|--|-----------------|
| 8 210 25 001 | Tool holder E4-30xER 25 | |
| | Shank size [mm]: | 30.00 |
| | Shank type: | VDI |
| | Tool adaption: | ER 25 |
| | Coolant: | IC |
| 8 210 25 002 | Tool holder E2-30x16 | |
| | Shank size [mm]: | 30.00 |
| | Shank type: | VDI |
| | Tool adaption: | Ø 16 |
| | Coolant: | IC/Ext |
| 8 210 25 004 | Tool holder E1-30x16 | |
| | Shank size [mm]: | 30.00 |
| | Shank type: | VDI |
| | Tool adaption: | Ø 16 |
| | Coolant: | IC |
| 8 210 25 009 | Short drill chuck VDI 30x16 | |
| | Weight [kg]: | 2.100 |
| | Shank size [mm]: | 30.00 |
| | Shank type: | VDI |
| | Coolant: | EXT |
| 8 210 25 013 | Short drill chuck VDI 30x16 - IC | |
| | Weight [kg]: | 1.880 |
| | Shank size [mm]: | 30.00 |
| | Shank type: | VDI |
| | Coolant: | IC |
| 8 210 25 016 | Tool holder E2-30x18 | |
| | Shank size [mm]: | 30.00 |
| | Shank type: | VDI |
| | Tool adaption: | Ø 18 |
| | Coolant: | IC/Ext |
| 8 210 25 017 | Tool holder E4-30xER 25 - special | |
| | Weight [kg]: | 0.980 |
| | Shank size [mm]: | 30.00 |
| | Shank type: | VDI |
| | Tool adaption: | ER 25 |
| | Coolant: | IC |
| | Please note: | Special |
| 8 210 25 024 | Tool holder ER 25 AX UT IC | |
| | Weight [kg]: | 1.050 |
| | Shank size [mm]: | 30.00 |
| | Shank type: | VDI |
| | Tool adaption: | ER 25 A - u-tec |
| | Coolant: | IC/Ext |
| 8 210 26 001 | Tool holder E1-30x20 | |
| | Shank size [mm]: | 30.00 |
| | Shank type: | VDI |
| | Tool adaption: | Ø 20 |
| | Coolant: | IC |

| Part-# | Name | |
|---------------------|-------------------------------------|-----------------|
| 8 210 26 002 | Tool holder E2-30x20 | |
| | Weight [kg]: | 1.380 |
| | Shank size [mm]: | 30.00 |
| | Shank type: | VDI |
| | Tool adaption: | Ø 20 |
| | Coolant: | IC/Ext |
| 8 210 26 005 | Tool holder E4-30xER 32 | |
| | Shank size [mm]: | 30.00 |
| | Shank type: | VDI |
| | Tool adaption: | ER 32 |
| | Coolant: | IC |
| 8 210 26 011 | Tool holder HT 4 IC | |
| | Weight [kg]: | 1.270 |
| | Version: | right |
| | Shank size [mm]: | 30.00 |
| | Shank type: | VDI |
| | Tool adaption: | HT 4 |
| | Coolant: | IC/Ext |
| 8 210 27 002 | Tool holder E2-30x25 | |
| | Weight [kg]: | 1.320 |
| | Shank size [mm]: | 30.00 |
| | Shank type: | VDI |
| | Tool adaption: | Ø 25 |
| | Coolant: | IC/Ext |
| 8 210 27 005 | Tool holder E1-30x25 | |
| | Shank size [mm]: | 30.00 |
| | Shank type: | VDI |
| | Tool adaption: | Ø 25 |
| | Coolant: | IC |
| 8 210 27 007 | Tool holder E3-30x C 25 | |
| | Shank size [mm]: | 30.00 |
| | Shank type: | VDI |
| | Tool adaption: | DIN 6388 - C 25 |
| | Coolant: | IC |
| 8 210 27 008 | Tool holder E4-30xER 40 | |
| | Shank size [mm]: | 30.00 |
| | Shank type: | VDI |
| | Tool adaption: | ER 40 |
| | Coolant: | IC |
| 8 210 27 015 | Tool holder E2-30x1" special | |
| | Shank size [mm]: | 30.00 |
| | Shank type: | VDI |
| | Tool adaption: | Ø 1" (25,4mm) |
| | Coolant: | IC/Ext |
| 8 210 28 001 | Tool holder E1-30x32 | |
| | Shank size [mm]: | 30.00 |
| | Shank type: | VDI |
| | Tool adaption: | Ø 32 |
| | Coolant: | IC |

| Part-# | Name | |
|---------------------|--------------------------------|-----------|
| 8 210 28 002 | Tool holder E2-30x32 | |
| | Shank size [mm]: | 30.00 |
| | Shank type: | VDI |
| | Tool adaption: | Ø 32 |
| | Coolant: | IC/Ext |
| 8 210 29 001 | Tool holder E1-30x40 | |
| | Shank size [mm]: | 30.00 |
| | Shank type: | VDI |
| | Tool adaption: | Ø 40 |
| | Coolant: | IC |
| 8 214 22 000 | Tool holder C1-30x20/16 | |
| | Employment for: | VDI 30 |
| | Version: | right |
| | Shank size [mm]: | 30.00 |
| | Shank type: | VDI |
| | Tool adaption: | Sq. 20/16 |
| | Coolant: | EXT |
| 8 214 22 001 | Tool holder C3-30x20/16 | |
| | Employment for: | VDI 30 |
| | Version: | right |
| | Shank size [mm]: | 30.00 |
| | Shank type: | VDI |
| | Tool adaption: | Sq. 20/16 |
| | Coolant: | EXT |
| 8 234 22 000 | Tool holder B3-30x20x40 | |
| | Employment for: | VDI 30 |
| | Shank size [mm]: | 30.00 |
| | Shank type: | VDI |
| | Tool adaption: | Sq. 20/16 |
| | Coolant: | EXT |
| 8 234 22 001 | Tool holder B1-30x20x40 | |
| | Employment for: | VDI 30 |
| | Version: | right |
| | Shank size [mm]: | 30.00 |
| | Shank type: | VDI |
| | Tool adaption: | Sq. 20/16 |
| | Coolant: | EXT |
| 8 234 22 002 | Tool holder B5-30x20x40 | |
| | Weight [kg]: | 1.790 |
| | Shank size [mm]: | 30.00 |
| | Shank type: | VDI |
| | Tool adaption: | Sq. 20/16 |
| | Coolant: | EXT |
| 8 234 22 003 | Tool holder B1-30x20x60 | |
| | Employment for: | VDI 30 |
| | Version: | right |
| | Shank size [mm]: | 30.00 |
| | Shank type: | VDI |
| | Tool adaption: | Sq. 20/16 |
| | Coolant: | EXT |

| Part-# | Name | |
|---------------------|--|---------------------------|
| 8 234 22 004 | Tool holder B3-30x20x60 | |
| | Employment for: | VDI 30 |
| | Shank size [mm]: | 30.00 |
| | Shank type: | VDI |
| | Tool adaption: | Sq. 20/16 |
| | Coolant: | EXT |
| 8 234 22 005 | Tool holder B5-30x20x60 | |
| | Shank size [mm]: | 30.00 |
| | Shank type: | VDI |
| | Tool adaption: | Sq. 20/16 |
| | Coolant: | EXT |
| 8 234 22 006 | Tool holder B7-30x20x40 | |
| | Weight [kg]: | 1.960 |
| | Shank size [mm]: | 30.00 |
| | Shank type: | VDI |
| | Tool adaption: | Sq. 20/16 |
| | Coolant: | EXT |
| 8 234 22 007 | Tool holder B7-30x20x60 | |
| | Weight [kg]: | 2.880 |
| | Employment for: | VDI 30 |
| | Shank size [mm]: | 30.00 |
| | Shank type: | VDI |
| | Tool adaption: | Sq. 20/16 |
| | Coolant: | EXT |
| 8 234 22 014 | Tool holder B1-30x20x80 special | |
| | Shank size [mm]: | 30.00 |
| | Shank type: | VDI |
| | Tool adaption: | Sq. 20/16 |
| | Coolant: | EXT |
| 8 234 22 015 | Tool holder B1-30x20x90 special | |
| | Shank size [mm]: | 30.00 |
| | Shank type: | VDI |
| | Tool adaption: | Sq. 20/16 |
| | Coolant: | EXT |
| 8 262 29 000 | Stock stop VDI 30 - Ø 42 | |
| | Weight [kg]: | 0.920 |
| | Notation: | rotating |
| | Shank size [mm]: | 30.00 |
| | Shank type: | VDI |
| | Please note: | Lenght adjustable 62-95mm |
| 8 262 29 003 | Stock stop VDI 30 - Ø 60 | |
| | Weight [kg]: | 1.180 |
| | Notation: | rotating |
| | Shank size [mm]: | 30.00 |
| | Shank type: | VDI |
| | Please note: | Lenght adjustable 62-95mm |

| Part-# | Name | |
|---------------------|---|--|
| 8 267 29 000 | Bar pick-up VDI 30 offset | |
| | Weight [kg]: | 1.450 |
| | Version: | right |
| | Shank size [mm]: | 30.00 |
| | Shank type: | VDI |
| | Please note: | Chuck jaws 42-65 mm special accessories |
| 8 274 22 000 | Tool holder D2-30x20 | |
| | Weight [kg]: | 2.220 |
| | Shank size [mm]: | 30.00 |
| | Shank type: | VDI |
| | Tool adaption: | Sq. 20/16 |
| | Coolant: | EXT |
| 8 274 22 001 | Tool holder D1-30x20 | |
| | Weight [kg]: | 2.040 |
| | Shank size [mm]: | 30.00 |
| | Shank type: | VDI |
| | Tool adaption: | Sq. 20/16 |
| | Coolant: | EXT |
| 8 320 22 018 | Cut-off holder, height adjustable SH 26 IC | |
| | Weight [kg]: | 1.780 |
| | Version: | universal |
| | Shank size [mm]: | 30.00 |
| | Shank type: | VDI |
| | Tool adaption: | Clampshaft SH 26 |
| | Coolant: | IC/Ext |
| | Pressure max [bar]: | 70 |
| 8 320 23 012 | Cut-off holder, height adjustable SH 32 IC | |
| | Weight [kg]: | 1.770 |
| | Version: | universal |
| | Shank size [mm]: | 30.00 |
| | Shank type: | VDI |
| | Tool adaption: | Clampshaft SH 32 |
| | Coolant: | IC/Ext |
| | Pressure max [bar]: | 70 |
| 8 320 29 005 | Cut-off holder, height adjustable 845 IC | |
| | Version: | universal |
| | Shank size [mm]: | 30.00 |
| | Shank type: | VDI |
| | Tool adaption: |  System 845 |
| | Coolant: | IC |
| | Pressure max [bar]: | 70 |
| 8 742 20 000 | Clamping ring Z1- VDI 30 | |
| | Weight [kg]: | 0.420 |
| | Shank size [mm]: | 30.00 |
| | Shank type: | VDI |
| | Coolant: | EXT |

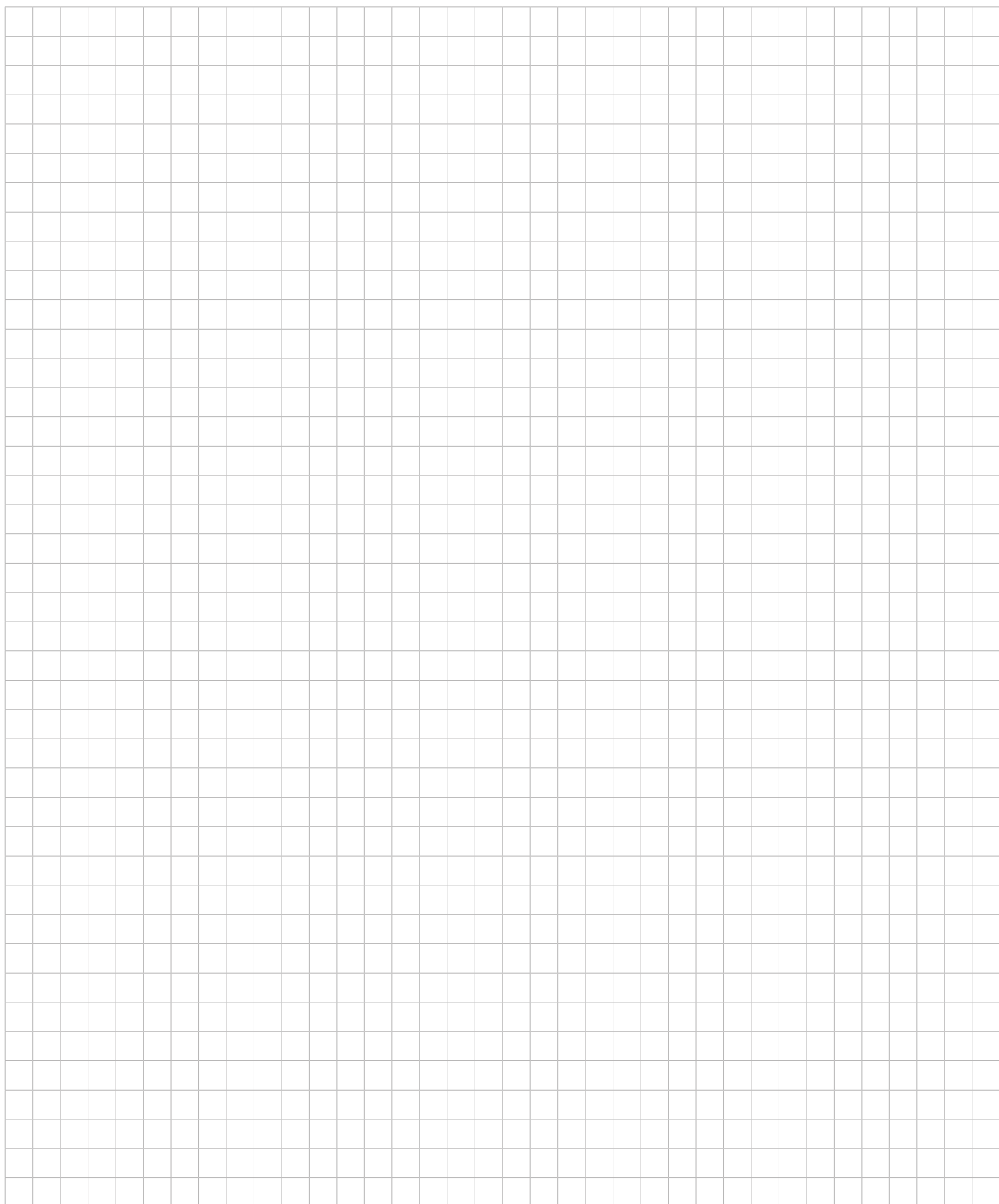

heimatec.u-tec®

heimatec.com

Products / Tool change systems /
u-tec® Tool-changing system



versions see catalog

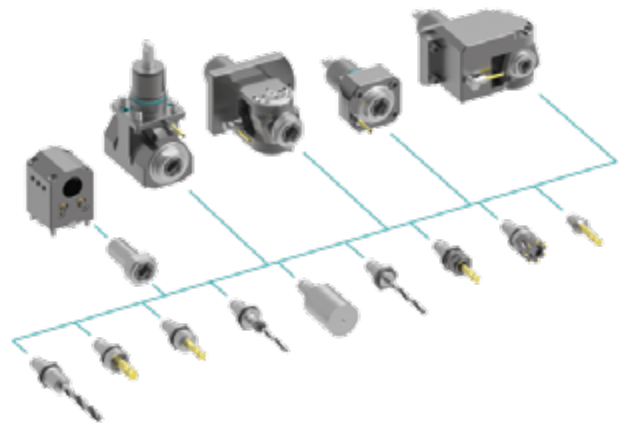

heimatec.easy-quick

heimatec.com

Products / Tool change systems /
easy-quick HT quick-changing system



versions see catalog

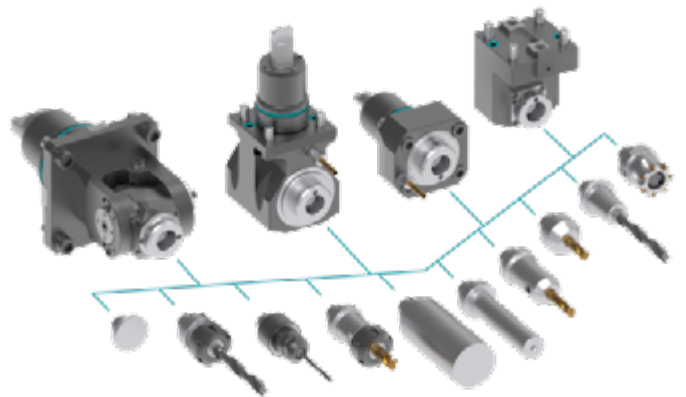

heimatec.Capto™

heimatec.com

Products / Tool change systems /
heimatec.Capto™ quick-changing system



versions see catalog

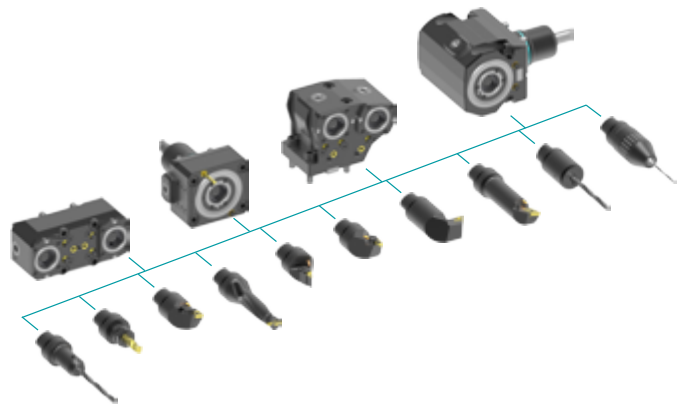

heimatec.accessories

heimatec.com

Products / Accessories



versions see catalog





● heimatec overseas branches

○ global representations of heimatec

heimatec[®]

heimatec GmbH
Präzisionswerkzeuge
Carl-Benz-Str. 4
77871 Renchen
Germany

T +49 7843 9466 0
www.heimatec.com
info@heimatec.com

Please find the contact details of our worldwide trading partners on our website:
<https://heimatec.com/business-partners>