

Nakamura  
**AS-200 - 12**  
**Stationen**



# High-tech from heimatec - heimatec - Tools and systems for productive turning and milling

heimatec belongs to the international technology and quality leaders for precision tools and specializes in the development and production of high-precision static and live tools for all CNC lathes, CNC turn-/mill machines and CNC machining centers.

The range of products\* spans from static BMT and VDI tool holders, live tools up to highly complex customer-specific individual solutions. heimatec, headquartered in Renchen, has a own subsidiary in Asia and India and numerous representatives as well as trading partners all over the world.

## \*OUR PRODCUTS

Static tool holders

Live tool units

Precision tools

Tools for turning and machining centres

Tools for swiss type lathes

Tool changing and uick-change systems



Tool systems for gear production

Digital tool management

This catalogue, including all its parts, is protected by copyright. Any use outside the restricted limitations of the Copyright Act without the consent of heimatec is inadmissible and liable to prosecution. This applies in particular to duplication, translation, microfilming and storage and processing in electronic systems.

**heimatec GmbH** reserves the right to make technical changes at any time without giving prior notice. This applies in particular to adjustments at any time to meet new or changed international standards, or in case of further developments of our products or manufacturing processes.

The current version of our General Terms and Conditions can be found on our website.

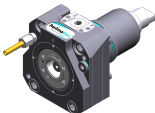
Part-#	Name	
<b>8 010 55 033</b>	<b>Axial milling and drill holder ER 25 AX UT</b>	
	Weight [kg]:	2.830
	Tool drive:	Flat (~DIN 1809)
	Shank size [mm]:	55.00
	Shank type:	BMT
	Tool adaption:	ER 25 A - u-tec
	Gear ratio [i]:	1:1
	Torque max [Nm]:	50
	Rotation max [1/min]:	6000
	Rotating direction:	same
	Coolant:	EXT
	Please note:	Combi bearing
<b>8 010 55 035</b>	<b>Axial milling and drill holder ER 25 AX UT IC</b>	
	Weight [kg]:	2.860
	Tool drive:	Flat (~DIN 1809)
	Shank size [mm]:	55.00
	Shank type:	BMT
	Tool adaption:	ER 25 A - u-tec
	Gear ratio [i]:	1:1
	Torque max [Nm]:	50
	Rotation max [1/min]:	6000
	Rotating direction:	same
	Coolant:	IC/Ext
	Pressure max [bar]:	100
	Please note:	Combi bearing; high pressure version; dryrun possible
<b>8 010 55 049</b>	<b>Axial drilling and milling head Weldon 16</b>	
	Weight [kg]:	3.140
	Tool drive:	Flat (~DIN 1809)
	Shank size [mm]:	55.00
	Shank type:	BMT
	Tool adaption:	Weldon (DIN 1835 b) 16
	Gear ratio [i]:	1:1
	Torque max [Nm]:	50
	Rotation max [1/min]:	6000
	Rotating direction:	same
	Coolant:	EXT
	Please note:	Combi bearing
<b>8 010 55 068</b>	<b>Axial drilling and milling head C 3</b>	
	Notation:	180° reversible
	Tool drive:	Flat (~DIN 1809)
	Shank type:	BMT
	Tool adaption:	heimatec Capto(TM) C 3
	Gear ratio [i]:	1:1
	Torque max [Nm]:	32
	Rotation max [1/min]:	8000
	Rotating direction:	same
	Coolant:	EXT

Part-#

Name

**8 010 55 069**

**Axial drilling and milling head C 3 IC**



Notation: 180° reversible  
Tool drive: Flat (~DIN 1809)  
Shank type: BMT  
Tool adaption: heimatec Capto(TM) C 3  
Gear ratio [i]: 1:1  
Torque max [Nm]: 32  
Rotation max [1/min]: 8000  
Rotating direction: same  
Coolant: IC/Ext  
Pressure max [bar]: 100

**8 010 55 078**

**Axial drilling and milling head Weldon 3/4" IC**



Weight [kg]: 3.200  
Tool drive: Flat (~DIN 1809)  
Shank size [mm]: 55.00  
Shank type: BMT  
Tool adaption: Weldon (DIN 1835 b) 3/4" (19,05mm)  
Gear ratio [i]: 1:1  
Torque max [Nm]: 50  
Rotation max [1/min]: 6000  
Rotating direction: same  
Coolant: IC/Ext  
Pressure max [bar]: 25  
Please note: Combi bearing

**8 010 55 081**

**Axial drilling and milling head Weldon 3/4"**



Weight [kg]: 3.200  
Tool drive: Flat (~DIN 1809)  
Shank size [mm]: 55.00  
Shank type: BMT  
Tool adaption: Weldon (DIN 1835 b) 3/4" (19,05mm)  
Gear ratio [i]: 1:1  
Torque max [Nm]: 50  
Rotation max [1/min]: 6000  
Rotating direction: same  
Coolant: EXT  
Please note: Combi bearing



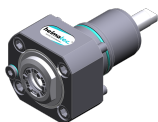

**8 010 55 092**

**Axial drilling and milling head ER 25 AX UT IC**

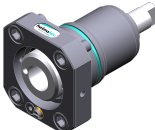





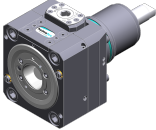

Weight [kg]: 2.870  
Tool drive: Flat (~DIN 1809)  
Shank size [mm]: 55.00  
Shank type: BMT  
Tool adaption: ER 25 A - u-tec  
Gear ratio [i]: 1:1  
Torque max [Nm]: 50  
Rotation max [1/min]: 6000  
Rotating direction: same  
Coolant: IC air  
Pressure max [bar]: 10  
Please note: Combi bearing

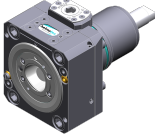
Part-#	Name	
<b>8 010 55 109</b>	<b>Axial drilling and milling head ER 25 AX UT</b>	
	Weight [kg]:	2.600
	Tool drive:	Flat (~DIN 1809)
	Shank size [mm]:	55.00
	Shank type:	BMT
	Tool adaption:	ER 25 A - u-tec
	Gear ratio [i]:	1:1
	Torque max [Nm]:	50
	Rotation max [1/min]:	12000
	Rotating direction:	same
	Coolant:	EXT
<b>8 010 55 111</b>	<b>Axial drilling and milling head ER 25 AX UT IC</b>	
	Weight [kg]:	3.000
	Tool drive:	Flat (~DIN 1809)
	Shank size [mm]:	55.00
	Shank type:	BMT
	Tool adaption:	ER 25 A - u-tec
	Gear ratio [i]:	1:1
	Torque max [Nm]:	50
	Rotation max [1/min]:	15000
	Rotating direction:	same
	Coolant:	IC/Ext
	Pressure max [bar]:	100
	Please note:	Dryrun possible
<b>8 010 56 031</b>	<b>Axial drilling and milling head HT 4 IC</b>	
	Weight [kg]:	1.760
	Tool drive:	Flat (~DIN 1809)
	Shank size [mm]:	55.00
	Shank type:	BMT
	Tool adaption:	HT 4
	Gear ratio [i]:	1:1
	Torque max [Nm]:	50
	Rotation max [1/min]:	6000
	Rotating direction:	same
	Coolant:	IC/Ext
	Pressure max [bar]:	25
	Please note:	short version
<b>8 010 56 032</b>	<b>Axial drilling and milling head HT 4</b>	
	Weight [kg]:	1.740
	Tool drive:	Flat (~DIN 1809)
	Shank size [mm]:	55.00
	Shank type:	BMT
	Tool adaption:	HT 4
	Gear ratio [i]:	1:1
	Torque max [Nm]:	50
	Rotation max [1/min]:	6000
	Rotating direction:	same
	Coolant:	EXT
	Please note:	short version



Part-#	Name	
<b>8 010 56 059</b>	<b>Axial drilling and milling head HT 4</b>	
	Weight [kg]:	2.880
	Tool drive:	Flat (~DIN 1809)
	Shank size [mm]:	55.00
	Shank type:	BMT
	Tool adaption:	HT 4
	Gear ratio [i]:	1:1
	Torque max [Nm]:	50
	Rotation max [1/min]:	6000
	Rotating direction:	same
	Coolant:	EXT
	Please note:	Combi bearing
<b>8 010 56 063</b>	<b>Axial milling and drill holder ER 32 AX UT</b>	
	Weight [kg]:	3.000
	Tool drive:	Flat (~DIN 1809)
	Shank size [mm]:	55.00
	Shank type:	BMT
	Tool adaption:	ER 32 A - u-tec
	Gear ratio [i]:	1:1
	Torque max [Nm]:	50
	Rotation max [1/min]:	6000
	Rotating direction:	same
	Coolant:	EXT
	Please note:	Combi bearing
<b>8 010 56 064</b>	<b>Axial milling and drill holder ER 32 AX UT IC</b>	
	Weight [kg]:	3.020
	Tool drive:	Flat (~DIN 1809)
	Shank size [mm]:	55.00
	Tool adaption:	ER 32 A - u-tec
	Gear ratio [i]:	1:1
	Torque max [Nm]:	50
	Rotation max [1/min]:	6000
	Rotating direction:	same
	Coolant:	IC/Ext
	Pressure max [bar]:	25
	Please note:	Combi bearing
<b>8 010 56 065</b>	<b>Axial milling and drill holder ER 32 AX UT IC</b>	
	Weight [kg]:	3.020
	Tool drive:	Flat (~DIN 1809)
	Shank size [mm]:	55.00
	Shank type:	BMT
	Tool adaption:	ER 32 A - u-tec
	Gear ratio [i]:	1:1
	Torque max [Nm]:	50
	Rotation max [1/min]:	6000
	Rotating direction:	same
	Coolant:	IC/Ext
	Pressure max [bar]:	100
	Please note:	Combi bearing; dryrun possible

Part-#	Name	
<b>8 010 56 066</b>	<b>Axial drilling and milling head HT 4 IC</b>	
	Weight [kg]:	2.930
	Tool drive:	Flat (~DIN 1809)
	Shank size [mm]:	55.00
	Shank type:	BMT
	Tool adaption:	HT 4
	Gear ratio [i]:	1:1
	Torque max [Nm]:	50
	Rotation max [1/min]:	6000
	Rotating direction:	same
	Coolant:	IC/Ext
	Pressure max [bar]:	25
	Please note:	Combi bearing
<b>8 010 56 110</b>	<b>Axial drilling and milling head C 4</b>	
	Weight [kg]:	4.750
	Notation:	180° reversible
	Tool drive:	Flat (~DIN 1809)
	Shank size [mm]:	55.00
	Shank type:	BMT
	Tool adaption:	heimatec Capto(TM) C 4
	Gear ratio [i]:	1:1
	Torque max [Nm]:	50
	Rotation max [1/min]:	6000
	Rotating direction:	same
	Coolant:	EXT
	Please note:	Check applicability; tool length check !
<b>8 010 56 111</b>	<b>Axial drilling and milling head C 4 IC</b>	
	Weight [kg]:	5.800
	Notation:	180° reversible
	Tool drive:	Flat (~DIN 1809)
	Shank size [mm]:	55.00
	Shank type:	BMT
	Machine adaption:	Centering key b 20
	Tool adaption:	heimatec Capto(TM) C 4
	Gear ratio [i]:	1:1
	Torque max [Nm]:	50
	Rotation max [1/min]:	6000
	Rotating direction:	same
	Coolant:	IC/Ext
	Pressure max [bar]:	100
	Please note:	Check applicability; tool length check !
<b>8 010 56 120</b>	<b>Axial drilling and milling head C 4 IC</b>	
	Notation:	180° reversible
	Tool drive:	Flat (~DIN 1809)
	Shank size [mm]:	55.00
	Shank type:	BMT
	Machine adaption:	Centering key b 20
	Tool adaption:	heimatec Capto(TM) C 4
	Gear ratio [i]:	1:1
	Torque max [Nm]:	50
	Rotation max [1/min]:	6000
	Rotating direction:	same
	Coolant:	IC/Ext

Part-#	Name	
	Pressure max [bar]:	25
	Please note:	Check applicability; tool length check !
<b>8 010 56 138</b>	<b>Axial drilling and milling head C 4</b>	
	Weight [kg]:	4.730
	Notation:	180° reversible
	Tool drive:	Flat (~DIN 1809)
	Shank size [mm]:	55.00
	Shank type:	BMT
	Tool adaption:	heimatec Capto(TM) C 4
	Gear ratio [i]:	1:1
	Torque max [Nm]:	50
	Rotation max [1/min]:	12000
	Rotating direction:	same
	Coolant:	EXT
	Please note:	Check applicability; tool length check !
<b>8 010 56 140</b>	<b>Axial drilling and milling head ER 32 AX UT IC</b>	
	Weight [kg]:	3.000
	Tool drive:	Flat (~DIN 1809)
	Shank size [mm]:	55.00
	Shank type:	BMT
	Tool adaption:	ER 32 A - u-tec
	Gear ratio [i]:	1:1
	Torque max [Nm]:	50
	Rotation max [1/min]:	6000
	Rotating direction:	same
	Coolant:	IC/Ext
	Pressure max [bar]:	100
<b>8 010 56 144</b>	<b>Axial drilling and milling head HT 4 IC</b>	
	Tool drive:	Flat (~DIN 1809)
	Shank size [mm]:	55.00
	Shank type:	BMT
	Tool adaption:	HT 4
	Gear ratio [i]:	1:1
	Torque max [Nm]:	50
	Rotation max [1/min]:	6000
	Rotating direction:	same
	Coolant:	IC/Ext
	Pressure max [bar]:	100
<b>8 010 56 151</b>	<b>Axial drilling and milling head ER 32 AX UT</b>	
	Weight [kg]:	2.770
	Tool drive:	Flat (~DIN 1809)
	Shank size [mm]:	55.00
	Shank type:	BMT
	Tool adaption:	ER 32 A - u-tec
	Gear ratio [i]:	1:1
	Torque max [Nm]:	50
	Rotation max [1/min]:	12000
	Rotating direction:	same
	Coolant:	EXT

Part-#	Name	
<b>8 010 56 153</b>	<b>Axial drilling and milling head ER 32 AX UT IC</b>	
	Weight [kg]:	3.180
	Tool drive:	Flat (~DIN 1809)
	Shank size [mm]:	55.00
	Shank type:	BMT
	Tool adaption:	ER 32 A - u-tec
	Gear ratio [i]:	1:1
	Torque max [Nm]:	50
	Rotation max [1/min]:	15000
	Rotating direction:	same
	Coolant:	IC/Ext
	Pressure max [bar]:	100
<b>8 011 54 006</b>	<b>Axial milling head universal arbor 3/4"</b>	
	Weight [kg]:	2.910
	Tool drive:	Flat (~DIN 1809)
	Shank size [mm]:	55.00
	Shank type:	BMT
	Tool adaption:	Universal arbor 3/4" (19,05mm)
	Gear ratio [i]:	1:1
	Torque max [Nm]:	50
	Rotation max [1/min]:	6000
	Rotating direction:	same
	Coolant:	EXT
	Please note:	Combi bearing
<b>8 011 54 015</b>	<b>Axial milling head arbor 5/8"</b>	
	Weight [kg]:	2.880
	Tool drive:	Flat (~DIN 1809)
	Shank size [mm]:	55.00
	Shank type:	BMT
	Tool adaption:	Arbor 5/8" (15,875mm)
	Gear ratio [i]:	1:1
	Torque max [Nm]:	50
	Rotation max [1/min]:	6000
	Rotating direction:	same
	Coolant:	EXT
	Please note:	Combi bearing
<b>8 011 55 014</b>	<b>Axial milling head universal arbor 22 IC</b>	
	Weight [kg]:	3.080
	Tool drive:	Flat (~DIN 1809)
	Shank size [mm]:	55.00
	Shank type:	BMT
	Tool adaption:	Universal arbor 22
	Gear ratio [i]:	1:1
	Torque max [Nm]:	50
	Rotation max [1/min]:	6000
	Rotating direction:	same
	Coolant:	IC/Ext
	Pressure max [bar]:	100
	Please note:	Combi bearing, Trockenauf possible

Part-#	Name	
<b>8 011 55 015</b>	<b>Axial milling head universal arbor 22</b>	
	Weight [kg]:	3.000
	Tool drive:	Flat (~DIN 1809)
	Shank size [mm]:	55.00
	Shank type:	BMT
	Tool adaption:	Universal arbor 22
	Gear ratio [i]:	1:1
	Torque max [Nm]:	50
	Rotation max [1/min]:	6000
	Rotating direction:	same
	Coolant:	EXT
	Please note:	Combi bearing
<b>8 013 53 000</b>	<b>Axial drilling and milling head ER 11</b>	
	Weight [kg]:	2.300
	Tool drive:	Flat (~DIN 1809)
	Shank size [mm]:	55.00
	Shank type:	BMT
	Tool adaption:	ER 11
	Gear ratio [i]:	1:4
	Torque max [Nm]:	2,5
	Rotation max [1/min]:	48000
	Rotating direction:	same
	Coolant:	EXT
<b>8 013 54 005</b>	<b>Axial drilling and milling head ER 16 AX UT</b>	
	Weight [kg]:	2.200
	Tool drive:	Flat (~DIN 1809)
	Shank size [mm]:	55.00
	Shank type:	BMT
	Tool adaption:	ER 16 A - u-tec
	Gear ratio [i]:	1:4
	Torque max [Nm]:	5
	Rotation max [1/min]:	24000
	Rotating direction:	same
	Coolant:	EXT
<b>8 013 54 007</b>	<b>Axial drilling and milling head ER 16 AX UT IC</b>	
	Tool drive:	Flat (~DIN 1809)
	Shank size [mm]:	55.00
	Shank type:	BMT
	Tool adaption:	ER 16 A - u-tec
	Gear ratio [i]:	1:4
	Torque max [Nm]:	5
	Rotation max [1/min]:	24000
	Rotating direction:	same
	Coolant:	IC/Ext
	Pressure max [bar]:	80
<b>8 019 51 002</b>	<b>Axial drilling and milling head CHC</b>	
	Weight [kg]:	6.880
	Notation:	IC-300
	Version:	no Splash-protection
	Tool drive:	Flat (~DIN 1809)
	Shank size [mm]:	55.00
	Shank type:	BMT

Part-#	Name	
	Tool adaption:	CHC
	Gear ratio [i]:	1:1,5
	Rotation max [1/min]:	18000
	Rotating direction:	same
	Coolant:	no
	Center distance [mm]:	77
<b>8 019 54 014</b>	<b>Axial drilling and milling head ER 20 AX UT IC</b>	
	Weight [kg]:	6.240
	Notation:	offset; 180° reversible
	Tool drive:	Flat (~DIN 1809)
	Shank size [mm]:	55.00
	Shank type:	BMT
	Tool adaption:	ER 20 A - u-tec
	Gear ratio [i]:	1:2
	Torque max [Nm]:	25
	Rotation max [1/min]:	12000
	Rotating direction:	opposite
	Coolant:	IC/Ext
	Pressure max [bar]:	140
	Please note:	stronger bearing
	Offset [mm]:	42
<b>8 019 54 055</b>	<b>Axial drilling and milling head ER 16 M IC</b>	
	Weight [kg]:	6.200
	Notation:	offset; 180° reversible
	Tool drive:	Flat (~DIN 1809)
	Shank size [mm]:	55.00
	Shank type:	BMT
	Tool adaption:	ER 16 M
	Gear ratio [i]:	1:2
	Torque max [Nm]:	25
	Rotation max [1/min]:	12000
	Rotating direction:	opposite
	Coolant:	IC/Ext
	Pressure max [bar]:	140
	Please note:	stronger bearing
	Offset [mm]:	42
<b>8 019 55 018</b>	<b>Axial drilling and milling head ER 25 AX UT</b>	
	Weight [kg]:	5.230
	Notation:	offset; 180° reversible
	Tool drive:	Flat (~DIN 1809)
	Shank size [mm]:	55.00
	Shank type:	BMT
	Tool adaption:	ER 25 A - u-tec
	Gear ratio [i]:	1:1
	Torque max [Nm]:	40
	Rotation max [1/min]:	6000
	Rotating direction:	opposite
	Coolant:	EXT
	Please note:	stronger bearing
	Offset [mm]:	42

Part-#

Name

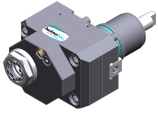
**8 019 55 023****Axial drilling and milling head ER 25 AX UT IC**

Weight [kg]: 6.260  
 Notation: offset; 180° reversible  
 Tool drive: Flat (~DIN 1809)  
 Shank size [mm]: 55.00  
 Shank type: BMT  
 Tool adaption: ER 25 A - u-tec  
 Gear ratio [i]: 1:1  
 Torque max [Nm]: 40  
 Rotation max [1/min]: 6000  
 Rotating direction: opposite  
 Coolant: IC/Ext  
 Pressure max [bar]: 140  
 Please note: stronger bearing  
 Offset [mm]: 42

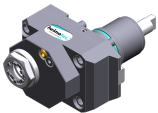
**8 019 55 024****Axial drilling and milling head ER 25 AX UT**

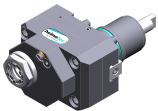

Weight [kg]: 5.230  
 Notation: offset; 180° reversible  
 Tool drive: Flat (~DIN 1809)  
 Shank size [mm]: 55.00  
 Shank type: BMT  
 Tool adaption: ER 25 A - u-tec  
 Gear ratio [i]: 1:2  
 Torque max [Nm]: 25  
 Rotation max [1/min]: 12000  
 Rotating direction: opposite  
 Coolant: EXT  
 Please note: stronger bearing  
 Offset [mm]: 42

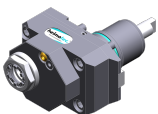

**8 019 55 025****Axial drilling and milling head ER 25 AX UT IC**

Weight [kg]: 6.330  
 Notation: offset; 180° reversible  
 Tool drive: Flat (~DIN 1809)  
 Shank size [mm]: 55.00  
 Shank type: BMT  
 Tool adaption: ER 25 A - u-tec  
 Gear ratio [i]: 1:2  
 Torque max [Nm]: 25  
 Rotation max [1/min]: 12000  
 Rotating direction: opposite  
 Coolant: IC/Ext  
 Pressure max [bar]: 140  
 Please note: stronger bearing  
 Offset [mm]: 42

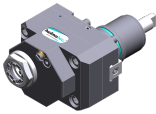
**8 019 55 026****Axial drilling and milling head ER 25 AX UT**

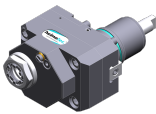
Weight [kg]: 5.300  
 Notation: offset; 180° reversible  
 Tool drive: Flat (~DIN 1809)  
 Shank size [mm]: 55.00  
 Shank type: BMT  
 Tool adaption: ER 25 A - u-tec  
 Gear ratio [i]: 1:3  
 Torque max [Nm]: 16

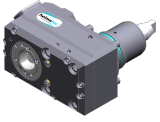
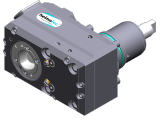
Part-#	Name	
	Rotation max [1/min]:	18000
	Rotating direction:	opposite
	Coolant:	EXT
	Please note:	stronger bearing
	Offset [mm]:	42
<b>8 019 55 027</b>	<b>Axial drilling and milling head ER 25 AX UT IC</b>	
	Weight [kg]:	6.350
	Notation:	offset; 180° reversible
	Tool drive:	Flat (~DIN 1809)
	Shank size [mm]:	55.00
	Shank type:	BMT
	Tool adaption:	ER 25 A - u-tec
	Gear ratio [i]:	1:3
	Torque max [Nm]:	16
	Rotation max [1/min]:	18000
	Rotating direction:	opposite
	Coolant:	IC/Ext
	Pressure max [bar]:	140
	Please note:	stronger bearing
	Offset [mm]:	42
<b>8 019 55 028</b>	<b>Axial drilling and milling head ER 25 AX UT</b>	
	Weight [kg]:	5.240
	Notation:	offset; 180° reversible
	Tool drive:	Flat (~DIN 1809)
	Shank size [mm]:	55.00
	Shank type:	BMT
	Tool adaption:	ER 25 A - u-tec
	Gear ratio [i]:	2:1
	Torque max [Nm]:	50
	Rotation max [1/min]:	3000
	Rotating direction:	opposite
	Coolant:	EXT
	Please note:	stronger bearing
	Offset [mm]:	42
<b>8 019 55 029</b>	<b>Axial drilling and milling head ER 25 AX UT IC</b>	
	Weight [kg]:	6.220
	Notation:	offset; 180° reversible
	Tool drive:	Flat (~DIN 1809)
	Shank size [mm]:	55.00
	Shank type:	BMT
	Tool adaption:	ER 25 A - u-tec
	Gear ratio [i]:	2:1
	Torque max [Nm]:	50
	Rotation max [1/min]:	3000
	Rotating direction:	opposite
	Coolant:	IC/Ext
	Pressure max [bar]:	140
	Please note:	stronger bearing
	Offset [mm]:	42

Part-#	Name	
<b>8 019 56 038</b>	<b>Axial drilling and milling head C 4</b>	
	Weight [kg]:	6.930
	Notation:	180° reversible
	Tool drive:	Flat (~DIN 1809)
	Shank size [mm]:	55.00
	Shank type:	BMT
	Tool adaption:	heimatec Capto(TM) C 4
	Gear ratio [i]:	1:1
	Torque max [Nm]:	50
	Rotation max [1/min]:	6000
	Rotating direction:	opposite
	Coolant:	EXT
	Please note:	Check applicability; note tool length!
	Offset [mm]:	62
<b>8 019 56 042</b>	<b>Axial drilling and milling head C 4 IC</b>	
	Weight [kg]:	7.720
	Notation:	180° reversible
	Tool drive:	Flat (~DIN 1809)
	Shank size [mm]:	55.00
	Shank type:	BMT
	Tool adaption:	heimatec Capto(TM) C 4
	Gear ratio [i]:	1:1
	Torque max [Nm]:	50
	Rotation max [1/min]:	6000
	Rotating direction:	opposite
	Coolant:	IC/Ext
	Pressure max [bar]:	140
	Please note:	Check applicability; note tool length!
	Offset [mm]:	62
<b>8 019 56 057</b>	<b>Axial drilling and milling head C 4 IC</b>	
	Weight [kg]:	7.650
	Notation:	180° reversible
	Tool drive:	Flat (~DIN 1809)
	Shank size [mm]:	55.00
	Shank type:	BMT
	Tool adaption:	heimatec Capto(TM) C 4
	Gear ratio [i]:	1:1
	Torque max [Nm]:	50
	Rotation max [1/min]:	12000
	Rotating direction:	opposite
	Coolant:	IC/Ext
	Pressure max [bar]:	140
	Please note:	Check applicability; note tool length!
	Offset [mm]:	62
<b>8 030 53 005</b>	<b>Radial drilling and milling head ER 11</b>	
	Weight [kg]:	5.210
	Notation:	180° reversible
	Tool drive:	Flat (~DIN 1809)
	Shank size [mm]:	55.00
	Shank type:	BMT
	Tool adaption:	ER 11
	Gear ratio [i]:	1:4
	Torque max [Nm]:	2,5

Part-#	Name
--------	------

Rotation max [1/min]: 48000  
 Rotating direction: opposite  
 Coolant: EXT  
 Please note: Check applicability!  
 Center distance [mm]: 65

**8 030 54 001 Radial drilling and milling head ER 20**



Weight [kg]: 4.750  
 Tool drive: Flat (~DIN 1809)  
 Shank size [mm]: 55.00  
 Shank type: BMT  
 Tool adaption: ER 20  
 Gear ratio [i]: 1:1  
 Torque max [Nm]: 25  
 Rotation max [1/min]: 6000  
 Rotating direction: opposite  
 Coolant: EXT  
 Center distance [mm]: 55

**8 030 54 049 Radial drilling and milling head ER 16 AX UT IC**



Weight [kg]: 6.500  
 Notation: 180° reversible  
 Tool drive: Flat (~DIN 1809)  
 Shank size [mm]: 55.00  
 Shank type: BMT  
 Tool adaption: ER 16 A - u-tec  
 Gear ratio [i]: 1:1  
 Torque max [Nm]: 50  
 Rotation max [1/min]: 6000  
 Rotating direction: opposite  
 Coolant: IC/Ext  
 Pressure max [bar]: 140  
 Please note: Combi bearing; high pressure version  
 Center distance [mm]: 65

**8 030 54 050 Radial drilling and milling head ER 16 AX UT IC**



Notation: 180° reversible  
 Tool drive: Flat (~DIN 1809)  
 Shank size [mm]: 55.00  
 Shank type: BMT  
 Tool adaption: ER 16 A - u-tec  
 Gear ratio [i]: 1:4  
 Torque max [Nm]: 5  
 Rotation max [1/min]: 24000  
 Rotating direction: opposite  
 Coolant: IC/Ext  
 Pressure max [bar]: 140  
 Center distance [mm]: 65

**8 030 54 056 Radial drilling and milling head ER 20 AX UT IC**



Weight [kg]: 5.320  
 Tool drive: Flat (~DIN 1809)  
 Shank size [mm]: 55.00  
 Shank type: BMT  
 Tool adaption: ER 20 A - u-tec  
 Gear ratio [i]: 1:1

Part-#

Name

Torque max [Nm]: 25  
 Rotation max [1/min]: 6000  
 Rotating direction: opposite  
 Coolant: IC/Ext  
 Pressure max [bar]: 140  
 Please note: Combi bearing  
 Center distance [mm]: 55

8 030 54 064

**Radial drilling and milling head ER 20 AX UT IC**

Weight [kg]: 6.520  
 Notation: 180° reversible  
 Tool drive: Flat (~DIN 1809)  
 Shank size [mm]: 55.00  
 Shank type: BMT  
 Tool adaption: ER 20 A - u-tec  
 Gear ratio [i]: 1:2  
 Torque max [Nm]: 16  
 Rotation max [1/min]: 12000  
 Rotating direction: same  
 Coolant: IC/Ext  
 Pressure max [bar]: 140  
 Please note: stronger bearing  
 Center distance [mm]: 77

8 030 55 004





**Radial drilling and milling head ER 25 IC**



Weight [kg]: 5.200  
 Tool drive: Flat (~DIN 1809)  
 Shank size [mm]: 55.00  
 Shank type: BMT  
 Tool adaption: ER 25  
 Gear ratio [i]: 1:1  
 Torque max [Nm]: 25  
 Rotation max [1/min]: 6000  
 Rotating direction: opposite  
 Coolant: IC/Ext  
 Pressure max [bar]: 140  
 Center distance [mm]: 55

8 030 55 007

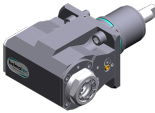

**Radial drilling and milling head ER 25**

Weight [kg]: 4.770  
 Tool drive: Flat (~DIN 1809)  
 Shank size [mm]: 55.00  
 Shank type: BMT  
 Tool adaption: ER 25  
 Gear ratio [i]: 1:1  
 Torque max [Nm]: 25  
 Rotation max [1/min]: 6000  
 Rotating direction: opposite  
 Coolant: EXT  
 Center distance [mm]: 55

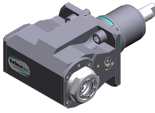
Part-#	Name	
<b>8 030 55 063</b>	<b>Radial drilling and milling head ER 25 AX UT</b>	
	Notation:	180° reversible
	Tool drive:	Flat (~DIN 1809)
	Shank size [mm]:	55.00
	Shank type:	BMT
	Tool adaption:	ER 25 A - u-tec
	Gear ratio [i]:	2:1
	Torque max [Nm]:	63
	Rotation max [1/min]:	6000
	Rotating direction:	opposite
	Coolant:	EXT
	Please note:	Combi bearing
	Center distance [mm]:	65
<b>8 030 55 087</b>	<b>Radial drilling and milling head Weldon 3/4"</b>	
	Weight [kg]:	6.690
	Notation:	180° reversible
	Tool drive:	Flat (~DIN 1809)
	Shank size [mm]:	55.00
	Shank type:	BMT
	Tool adaption:	Weldon (DIN 1835 b) 3/4" (19,05mm)
	Gear ratio [i]:	1:1
	Torque max [Nm]:	50
	Rotation max [1/min]:	6000
	Rotating direction:	opposite
	Coolant:	EXT
	Please note:	Combi bearing
	Center distance [mm]:	65
<b>8 030 55 091</b>	<b>Angle-mill- and drill holder ER 25 AX UT IC</b>	
	Weight [kg]:	6.680
	Notation:	180° reversible
	Tool drive:	Flat (~DIN 1809)
	Shank size [mm]:	55.00
	Shank type:	BMT
	Tool adaption:	ER 25 A - u-tec
	Gear ratio [i]:	1:1
	Torque max [Nm]:	50
	Rotation max [1/min]:	6000
	Rotating direction:	opposite
	Coolant:	IC/Ext
	Pressure max [bar]:	140
	Please note:	Combi bearing; high pressure version
	Center distance [mm]:	65
<b>8 030 55 092</b>	<b>Angle-mill- and drill holder ER 25 AX UT</b>	
	Weight [kg]:	6.320
	Notation:	180° reversible
	Tool drive:	Flat (~DIN 1809)
	Shank size [mm]:	55.00
	Shank type:	BMT
	Tool adaption:	ER 25 A - u-tec
	Gear ratio [i]:	1:1
	Torque max [Nm]:	50
	Rotation max [1/min]:	6000
	Rotating direction:	opposite

Part-#	Name	
	Coolant:	EXT
	Please note:	Combi bearing
	Center distance [mm]:	65
<b>8 030 55 122</b>	<b>Radial drilling and milling head ER 25 AX UT</b>	
	Weight [kg]:	6.380
	Notation:	180° reversible
	Tool drive:	Flat (~DIN 1809)
	Shank size [mm]:	55.00
	Shank type:	BMT
	Tool adaption:	ER 25 A - u-tec
	Gear ratio [i]:	1:2
	Torque max [Nm]:	16
	Rotation max [1/min]:	12000
	Rotating direction:	same
	Coolant:	EXT
	Please note:	stronger bearing; check applicability;
	Center distance [mm]:	77
<b>8 030 55 131</b>	<b>Radial drilling and milling head ER 25 AX UT</b>	
	Weight [kg]:	4.980
	Tool drive:	Flat (~DIN 1809)
	Shank size [mm]:	55.00
	Shank type:	BMT
	Tool adaption:	ER 25 A - u-tec
	Gear ratio [i]:	1:1
	Torque max [Nm]:	25
	Rotation max [1/min]:	6000
	Rotating direction:	opposite
	Coolant:	EXT
	Please note:	stronger bearing
	Center distance [mm]:	55
<b>8 030 55 139</b>	<b>Radial drilling and milling head ER 25 AX UT IC</b>	
	Weight [kg]:	6.560
	Notation:	180° reversible
	Tool drive:	Flat (~DIN 1809)
	Shank size [mm]:	55.00
	Shank type:	BMT
	Tool adaption:	ER 25 A - u-tec
	Gear ratio [i]:	1:3
	Torque max [Nm]:	12
	Rotation max [1/min]:	18000
	Rotating direction:	same
	Coolant:	IC/Ext
	Pressure max [bar]:	140
	Please note:	stronger bearing
	Center distance [mm]:	77
<b>8 030 55 140</b>	<b>Radial drilling and milling head ER 25 AX UT</b>	
	Weight [kg]:	6.700
	Notation:	180° reversible
	Tool drive:	Flat (~DIN 1809)
	Shank size [mm]:	55.00
	Shank type:	BMT
	Tool adaption:	ER 25 A - u-tec
	Gear ratio [i]:	1:3

Part-#	Name	
	Torque max [Nm]:	12
	Rotation max [1/min]:	18000
	Rotating direction:	same
	Coolant:	EXT
	Please note:	stronger bearing
	Center distance [mm]:	77
<b>8 030 55 154</b>	<b>Radial drilling and milling head ER 25 AX UT IC</b>	
	Weight [kg]:	5.390
	Tool drive:	Flat (~DIN 1809)
	Shank size [mm]:	55.00
	Shank type:	BMT
	Tool adaption:	ER 25 A - u-tec
	Gear ratio [i]:	1:1
	Torque max [Nm]:	25
	Rotation max [1/min]:	6000
	Rotating direction:	opposite
	Coolant:	IC/Ext
	Pressure max [bar]:	140
	Please note:	High pressure version, stronger bearing
	Center distance [mm]:	55
<b>8 030 55 158</b>	<b>Radial drilling and milling head C 3 IC</b>	
	Weight [kg]:	8.280
	Notation:	180° reversible
	Tool drive:	Flat (~DIN 1809)
	Shank size [mm]:	55.00
	Shank type:	BMT
	Tool adaption:	heimatec Capto(TM) C 3
	Gear ratio [i]:	1:1
	Torque max [Nm]:	25
	Rotation max [1/min]:	8000
	Rotating direction:	opposite
	Coolant:	IC/Ext
	Pressure max [bar]:	140
	Please note:	Check applicability; note tool length!
	Center distance [mm]:	65
<b>8 030 55 159</b>	<b>Radial drilling and milling head ER 25 AX UT</b>	
	Weight [kg]:	7.710
	Notation:	180° reversible
	Tool drive:	Flat (~DIN 1809)
	Shank size [mm]:	55.00
	Shank type:	BMT
	Tool adaption:	ER 25 A - u-tec
	Gear ratio [i]:	1:3
	Torque max [Nm]:	12
	Rotation max [1/min]:	18000
	Rotating direction:	same
	Coolant:	EXT
	Please note:	stronger bearing
	Center distance [mm]:	107

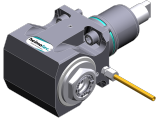
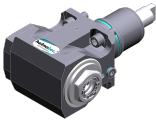
Part-#	Name	
<b>8 030 55 216</b>	<b>Angle-mill- and drill holder ER 25 AX UT</b>	
	Notation:	180° reversible
	Tool drive:	Flat (~DIN 1809)
	Shank size [mm]:	55.00
	Shank type:	BMT
	Tool adaption:	ER 25 A - u-tec
	Gear ratio [i]:	1:1
	Torque max [Nm]:	50
	Rotation max [1/min]:	6000
	Rotating direction:	opposite
	Coolant:	EXT
	Please note:	Combi bearing; check applicability
	Center distance [mm]:	95
<b>8 030 55 217</b>	<b>Angle-mill- and drill holder ER 25 AX UT IC</b>	
	Notation:	180° reversible
	Tool drive:	Flat (~DIN 1809)
	Shank size [mm]:	55.00
	Shank type:	BMT
	Tool adaption:	ER 25 A - u-tec
	Gear ratio [i]:	1:1
	Torque max [Nm]:	50
	Rotation max [1/min]:	6000
	Rotating direction:	opposite
	Coolant:	IC/Ext
	Pressure max [bar]:	140
	Please note:	Combi bearing; Einsetzbarkeit check!
	Center distance [mm]:	95
<b>8 030 55 238</b>	<b>Radial drilling and milling head ER 25 AX UT</b>	
	Weight [kg]:	6.100
	Notation:	180° reversible
	Tool drive:	Flat (~DIN 1809)
	Shank size [mm]:	55.00
	Shank type:	BMT
	Tool adaption:	ER 25 A - u-tec
	Gear ratio [i]:	1:1
	Torque max [Nm]:	50
	Rotation max [1/min]:	12000
	Rotating direction:	opposite
	Coolant:	EXT
	Center distance [mm]:	65
<b>8 030 55 239</b>	<b>Radial drilling and milling head ER 25 AX UT IC</b>	
	Weight [kg]:	6.470
	Notation:	180° reversible
	Tool drive:	Flat (~DIN 1809)
	Shank size [mm]:	55.00
	Shank type:	BMT
	Tool adaption:	ER 25 A - u-tec
	Gear ratio [i]:	1:1
	Torque max [Nm]:	50
	Rotation max [1/min]:	12000
	Rotating direction:	opposite
	Coolant:	IC/Ext
	Pressure max [bar]:	140

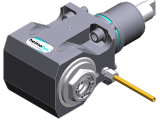
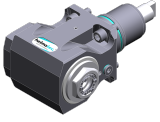
Part-#	Name	
	Center distance [mm]:	65
<b>8 030 55 240</b>	<b>Radial drilling and milling head ER 25 AX UT</b>	
	Weight [kg]:	6.380
	Notation:	180° reversible
	Tool drive:	Flat (~DIN 1809)
	Shank size [mm]:	55.00
	Shank type:	BMT
	Tool adaption:	ER 25 A - u-tec
	Gear ratio [i]:	1:1
	Torque max [Nm]:	50
	Rotation max [1/min]:	12000
	Rotating direction:	opposite
	Coolant:	EXT
	Center distance [mm]:	75
<b>8 030 55 241</b>	<b>Angle drilling and milling head ER 25 AX UT IC</b>	
	Weight [kg]:	6.960
	Notation:	180° reversible
	Tool drive:	Flat (~DIN 1809)
	Shank size [mm]:	55.00
	Shank type:	BMT
	Tool adaption:	ER 25 A - u-tec
	Gear ratio [i]:	1:1
	Torque max [Nm]:	50
	Rotation max [1/min]:	12000
	Rotating direction:	opposite
	Coolant:	IC/Ext
	Pressure max [bar]:	140
	Center distance [mm]:	75
<b>8 030 55 244</b>	<b>Angle-mill- and drill holder ER 25 AS UT</b>	
	Notation:	180° reversible
	Tool drive:	Flat (~DIN 1809)
	Shank size [mm]:	55.00
	Shank type:	BMT
	Tool adaption:	ER 25 A - u-tec
	Gear ratio [i]:	1:1
	Torque max [Nm]:	50
	Rotation max [1/min]:	6000
	Rotating direction:	opposite
	Coolant:	EXT
	Please note:	Combi bearing
	Center distance [mm]:	65
<b>8 030 55 246</b>	<b>Radial drilling and milling head ER 25 AS UT</b>	
	Notation:	180° reversible
	Tool drive:	Flat (~DIN 1809)
	Shank size [mm]:	55.00
	Shank type:	BMT
	Tool adaption:	ER 25 A - u-tec
	Gear ratio [i]:	1:1
	Torque max [Nm]:	50
	Rotation max [1/min]:	12000
	Rotating direction:	opposite
	Coolant:	EXT
	Center distance [mm]:	65

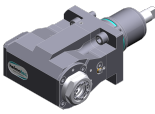
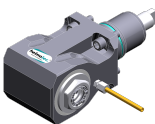
Part-#	Name	
<b>8 030 55 247</b>	<b>Radial drilling and milling head ER 25 AS UT IC</b>	
	Notation:	180° reversible
	Tool drive:	Flat (~DIN 1809)
	Shank size [mm]:	55.00
	Shank type:	BMT
	Tool adaption:	ER 25 A - u-tec
	Gear ratio [i]:	1:1
	Torque max [Nm]:	50
	Rotation max [1/min]:	12000
	Rotating direction:	opposite
	Coolant:	IC/Ext
	Pressure max [bar]:	140
	Center distance [mm]:	65
<b>8 030 55 250</b>	<b>Radial drilling and milling head ER 25 AX UT IC</b>	
	Weight [kg]:	8.170
	Notation:	180° reversible
	Tool drive:	Flat (~DIN 1809)
	Shank size [mm]:	55.00
	Shank type:	BMT
	Tool adaption:	ER 25 A - u-tec
	Gear ratio [i]:	1:1
	Torque max [Nm]:	50
	Rotation max [1/min]:	12000
	Rotating direction:	opposite
	Coolant:	IC/Ext
	Pressure max [bar]:	140
	Please note:	Check applicability; note tool length!
	Center distance [mm]:	100
<b>8 030 55 251</b>	<b>Radial drilling and milling head ER 25 AX UT IC</b>	
	Weight [kg]:	7.520
	Notation:	180° reversible
	Tool drive:	Flat (~DIN 1809)
	Shank size [mm]:	55.00
	Shank type:	BMT
	Tool adaption:	ER 25 A - u-tec
	Gear ratio [i]:	1:2
	Torque max [Nm]:	16
	Rotation max [1/min]:	16000
	Rotating direction:	same
	Coolant:	IC/Ext
	Pressure max [bar]:	140
	Please note:	stronger bearing; check applicability;
	Center distance [mm]:	100
<b>8 030 55 262</b>	<b>Radial drilling and milling head ER 25 AX UT</b>	
	Weight [kg]:	7.500
	Notation:	180° reversible
	Tool drive:	Flat (~DIN 1809)
	Shank size [mm]:	55.00
	Shank type:	BMT
	Tool adaption:	ER 25 A - u-tec
	Gear ratio [i]:	1:1
	Torque max [Nm]:	50
	Rotation max [1/min]:	12000
	Rotating direction:	opposite

Part-#	Name
--------	------

Coolant: EXT  
Please note: Check applicability!  
Center distance [mm]: 95

**8 030 55 263 Radial drilling and milling head ER 25 AX UT IC**

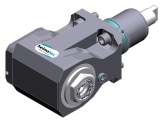

Weight [kg]: 7.980  
Notation: 180° reversible  
Tool drive: Flat (~DIN 1809)  
Shank size [mm]: 55.00  
Shank type: BMT  
Tool adaption: ER 25 A - u-tec  
Gear ratio [i]: 1:1  
Torque max [Nm]: 50  
Rotation max [1/min]: 12000  
Rotating direction: opposite  
Coolant: IC/Ext  
Pressure max [bar]: 140  
Please note: Check applicability!  
Center distance [mm]: 95

**8 030 56 013 Radial drilling and milling head HT 4**

Weight [kg]: 4.620  
Tool drive: Flat (~DIN 1809)  
Shank size [mm]: 55.00  
Shank type: BMT  
Tool adaption: HT 4  
Gear ratio [i]: 1:1  
Torque max [Nm]: 25  
Rotation max [1/min]: 6000  
Rotating direction: opposite  
Coolant: EXT  
Center distance [mm]: 55



**8 030 56 059 Radial drilling and milling head HT 4 IC**

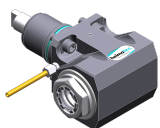

Notation: 180° reversible  
Version: long  
Tool drive: Flat (~DIN 1809)  
Shank size [mm]: 55.00  
Shank type: BMT  
Tool adaption: HT 4  
Gear ratio [i]: 2:1  
Torque max [Nm]: 63  
Rotation max [1/min]: 3000  
Rotating direction: opposite  
Coolant: IC/Ext  
Pressure max [bar]: 140  
Please note: Combi bearing  
Center distance [mm]: 65

**8 030 56 070 Radial drilling and milling head ER 32 AX UT**

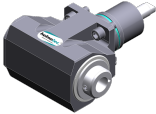

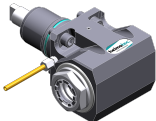
Notation: 180° reversible  
Tool drive: Flat (~DIN 1809)  
Shank size [mm]: 55.00  
Shank type: BMT  
Tool adaption: ER 32 A - u-tec  
Gear ratio [i]: 2:1  
Torque max [Nm]: 63

Part-#	Name	
	Rotation max [1/min]:	6000
	Rotating direction:	opposite
	Coolant:	EXT
	Please note:	Combi bearing
	Center distance [mm]:	65
<b>8 030 56 075</b>	<b>Radial drilling and milling head HT 4 IC</b>	
	Weight [kg]:	6.580
	Notation:	180° reversible
	Tool drive:	Flat (~DIN 1809)
	Shank size [mm]:	55.00
	Shank type:	BMT
	Tool adaption:	HT 4
	Gear ratio [i]:	1:1
	Torque max [Nm]:	50
	Rotation max [1/min]:	6000
	Rotating direction:	opposite
	Coolant:	IC/Ext
	Pressure max [bar]:	140
	Please note:	Combi bearing
	Center distance [mm]:	65
<b>8 030 56 090</b>	<b>Radial drilling and milling head ER 32 AX UT IC</b>	
	Notation:	180° reversible
	Tool drive:	Flat (~DIN 1809)
	Shank size [mm]:	55.00
	Shank type:	BMT
	Tool adaption:	ER 32 A - u-tec
	Gear ratio [i]:	2:1
	Torque max [Nm]:	63
	Rotation max [1/min]:	6000
	Rotating direction:	opposite
	Coolant:	IC/Ext
	Pressure max [bar]:	140
	Please note:	Combi bearing
	Center distance [mm]:	65
<b>8 030 56 095</b>	<b>Angle-mill- and drill holder ER 32 AX UT</b>	
	Weight [kg]:	6.320
	Notation:	180° reversible
	Tool drive:	Flat (~DIN 1809)
	Shank size [mm]:	55.00
	Shank type:	BMT
	Tool adaption:	ER 32 A - u-tec
	Gear ratio [i]:	1:1
	Torque max [Nm]:	50
	Rotation max [1/min]:	6000
	Rotating direction:	opposite
	Coolant:	EXT
	Please note:	Combi bearing
	Center distance [mm]:	65

Part-#	Name	
<b>8 030 56 096</b>	<b>Angle-mill- and drill holder ER 32 AX UT IC</b>	
	Weight [kg]:	6.700
	Notation:	180° reversible
	Tool drive:	Flat (~DIN 1809)
	Shank size [mm]:	55.00
	Tool adaption:	ER 32 A - u-tec
	Gear ratio [i]:	1:1
	Torque max [Nm]:	50
	Rotation max [1/min]:	6000
	Rotating direction:	opposite
	Coolant:	IC/Ext
	Pressure max [bar]:	140
	Please note:	Combi bearing
	Center distance [mm]:	65
<b>8 030 56 176</b>	<b>Radial drilling and milling head C 4</b>	
	Notation:	180° reversible
	Tool drive:	Flat (~DIN 1809)
	Shank size [mm]:	55.00
	Shank type:	BMT
	Tool adaption:	heimatec Capto(TM) C 4
	Gear ratio [i]:	1:1
	Torque max [Nm]:	40
	Rotation max [1/min]:	6000
	Rotating direction:	opposite
	Coolant:	EXT
	Pressure max [bar]:	140
	Please note:	Check applicability; note tool length!
	Center distance [mm]:	65
<b>8 030 56 177</b>	<b>Radial drilling and milling head C 4 IC</b>	
	Weight [kg]:	9.780
	Notation:	180° reversible
	Tool drive:	Flat (~DIN 1809)
	Shank size [mm]:	55.00
	Shank type:	BMT
	Tool adaption:	heimatec Capto(TM) C 4
	Gear ratio [i]:	1:1
	Torque max [Nm]:	40
	Rotation max [1/min]:	6000
	Rotating direction:	opposite
	Coolant:	IC/Ext
	Pressure max [bar]:	140
	Please note:	Check applicability; note tool length!
	Center distance [mm]:	65
<b>8 030 56 214</b>	<b>Radial drilling and milling head C 4 IC</b>	
	Notation:	180° reversible
	Tool drive:	Flat (~DIN 1809)
	Shank size [mm]:	55.00
	Shank type:	BMT
	Tool adaption:	heimatec Capto(TM) C 4
	Gear ratio [i]:	1:1
	Torque max [Nm]:	63
	Rotation max [1/min]:	12000
	Rotating direction:	opposite
	Coolant:	IC/Ext

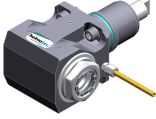
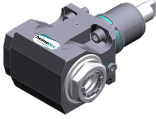
Part-#	Name	
	Pressure max [bar]:	140
	Please note:	Check applicability; note tool length!
	Center distance [mm]:	65
<b>8 030 56 215</b>	<b>Radial drilling and milling head C 4</b>	
	Notation:	180° reversible
	Tool drive:	Flat (~DIN 1809)
	Shank size [mm]:	55.00
	Shank type:	BMT
	Tool adaption:	heimatec Capto(TM) C 4
	Gear ratio [i]:	1:1
	Torque max [Nm]:	63
	Rotation max [1/min]:	12000
	Rotating direction:	opposite
	Coolant:	EXT
	Please note:	Check applicability; note tool length!
	Center distance [mm]:	65
<b>8 030 56 216</b>	<b>Radial drilling and milling head Weldon 20 IC</b>	
	Weight [kg]:	7.040
	Notation:	180° reversible
	Tool drive:	Flat (~DIN 1809)
	Shank size [mm]:	55.00
	Shank type:	BMT
	Tool adaption:	Weldon (DIN 1835 b) 20
	Gear ratio [i]:	1:1
	Torque max [Nm]:	50
	Rotation max [1/min]:	12000
	Rotating direction:	opposite
	Coolant:	IC/Ext
	Pressure max [bar]:	140
	Please note:	stronger bearing; high pressure version
	Center distance [mm]:	65
<b>8 030 56 235</b>	<b>Radial drilling and milling head ER 32 AX UT</b>	
	Weight [kg]:	6.050
	Notation:	180° reversible
	Tool drive:	Flat (~DIN 1809)
	Shank size [mm]:	55.00
	Shank type:	BMT
	Tool adaption:	ER 32 A - u-tec
	Gear ratio [i]:	1:1
	Torque max [Nm]:	50
	Rotation max [1/min]:	12000
	Rotating direction:	opposite
	Coolant:	EXT
	Center distance [mm]:	65
<b>8 030 56 236</b>	<b>Radial drilling and milling head ER 32 AX UT IC</b>	
	Weight [kg]:	5.830
	Notation:	180° reversible
	Tool drive:	Flat (~DIN 1809)
	Shank size [mm]:	55.00
	Shank type:	BMT
	Tool adaption:	ER 32 A - u-tec
	Gear ratio [i]:	1:1
	Torque max [Nm]:	50

Part-#

Name

Rotation max [1/min]: 12000  
 Rotating direction: opposite  
 Coolant: IC/Ext  
 Pressure max [bar]: 140  
 Center distance [mm]: 65

**8 030 56 237****Radial drilling and milling head ER 32 AX UT**



Weight [kg]: 6.500  
 Notation: 180° reversible  
 Tool drive: Flat (~DIN 1809)  
 Shank size [mm]: 55.00  
 Shank type: BMT  
 Tool adaption: ER 32 A - u-tec  
 Gear ratio [i]: 1:1  
 Torque max [Nm]: 50  
 Rotation max [1/min]: 12000  
 Rotating direction: opposite  
 Coolant: EXT  
 Center distance [mm]: 75

**8 030 56 238****Radial drilling and milling head ER 32 AX UT IC**

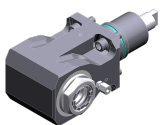
Weight [kg]: 7.200  
 Notation: 180° reversible  
 Tool drive: Flat (~DIN 1809)  
 Shank size [mm]: 55.00  
 Shank type: BMT  
 Tool adaption: ER 32 A - u-tec  
 Gear ratio [i]: 1:1  
 Torque max [Nm]: 50  
 Rotation max [1/min]: 12000  
 Rotating direction: opposite  
 Coolant: IC/Ext  
 Pressure max [bar]: 140  
 Center distance [mm]: 75

**8 030 56 239****Radial drilling and milling head ER 32 AX UT**

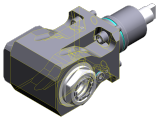
Weight [kg]: 7.500  
 Notation: 180° reversible  
 Tool drive: Flat (~DIN 1809)  
 Shank size [mm]: 55.00  
 Shank type: BMT  
 Tool adaption: ER 32 A - u-tec  
 Gear ratio [i]: 1:1  
 Torque max [Nm]: 50  
 Rotation max [1/min]: 12000  
 Rotating direction: opposite  
 Coolant: EXT  
 Please note: Check applicability!  
 Center distance [mm]: 95

Part-#	Name		
	<b>8 030 56 240</b>	<b>Radial drilling and milling head ER 32 AX UT IC</b>	
	Weight [kg]:	7.960	
	Notation:	180° reversible	
	Tool drive:	Flat (~DIN 1809)	
	Shank size [mm]:	55.00	
	Shank type:	BMT	
	Tool adaption:	ER 32 A - u-tec	
	Gear ratio [i]:	1:1	
	Torque max [Nm]:	50	
	Rotation max [1/min]:	12000	
	Rotating direction:	opposite	
	Coolant:	IC/Ext	
	Pressure max [bar]:	140	
	Please note:	Check applicability!	
Center distance [mm]:	95		
	<b>8 030 56 249</b>	<b>Radial drilling and milling head HT 4 IC</b>	
	Weight [kg]:	6.580	
	Notation:	180° reversible	
	Tool drive:	Flat (~DIN 1809)	
	Shank size [mm]:	55.00	
	Shank type:	BMT	
	Tool adaption:	HT 4	
	Gear ratio [i]:	1:1	
	Torque max [Nm]:	50	
	Rotation max [1/min]:	12000	
	Rotating direction:	opposite	
	Coolant:	IC/Ext	
	Pressure max [bar]:	140	
	Center distance [mm]:	65	
	<b>8 030 56 271</b>	<b>Radial drilling and milling head ER 32 AX UT</b>	
	Weight [kg]:	6.380	
	Notation:	180° reversible	
	Tool drive:	Flat (~DIN 1809)	
	Shank size [mm]:	55.00	
	Shank type:	BMT	
	Tool adaption:	ER 32 A - u-tec	
	Gear ratio [i]:	1:1	
	Torque max [Nm]:	50	
	Rotation max [1/min]:	12000	
	Rotating direction:	opposite	
	Coolant:	EXT	
	Please note:	stronger bearing	
	Center distance [mm]:	65	
	<b>8 030 56 275</b>	<b>Radial drilling and milling head ER 32 AX UT IC</b>	
	Weight [kg]:	6.700	
	Notation:	180° reversible	
	Tool drive:	Flat (~DIN 1809)	
	Shank size [mm]:	55.00	
	Shank type:	BMT	
	Tool adaption:	ER 32 A - u-tec	
	Gear ratio [i]:	1:1	
	Torque max [Nm]:	50	
	Rotation max [1/min]:	12000	
	Rotating direction:	opposite	

Part-#	Name
--------	------

Coolant:	IC/Ext
Pressure max [bar]:	140
Please note:	stronger bearing
Center distance [mm]:	65

**8 030 57 044 Radial drilling and milling head Weldon 25 IC**

Weight [kg]:	7.150
Notation:	180° reversible
Tool drive:	Flat (~DIN 1809)
Shank size [mm]:	55.00
Shank type:	BMT
Tool adaption:	Weldon (DIN 1835 b) 25
Gear ratio [i]:	1:1
Torque max [Nm]:	50
Rotation max [1/min]:	6000
Rotating direction:	opposite
Coolant:	IC/Ext
Pressure max [bar]:	140
Please note:	Combi bearing
Center distance [mm]:	65

**8 030 57 120 Radial drilling and milling head ER 40 AX UT**

Notation:	180° reversible
Tool drive:	Flat (~DIN 1809)
Shank size [mm]:	55.00
Shank type:	BMT
Tool adaption:	ER 40 A - u-tec
Gear ratio [i]:	1:1
Torque max [Nm]:	50
Rotation max [1/min]:	6000
Rotating direction:	opposite
Coolant:	EXT
Please note:	stronger bearing
Center distance [mm]:	65

**8 031 54 014 Radial milling head universal arbor 16**

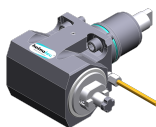

Weight [kg]:	6.500
Notation:	180° reversible
Tool drive:	Flat (~DIN 1809)
Shank size [mm]:	55.00
Shank type:	BMT
Tool adaption:	Universal arbor 16
Gear ratio [i]:	1:1
Torque max [Nm]:	50
Rotation max [1/min]:	6000
Rotating direction:	opposite
Coolant:	EXT
Please note:	Combi bearing
Center distance [mm]:	65

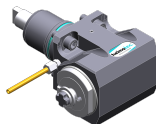

**8 031 54 015 Radial polygon head arbor 16**

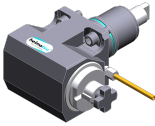

Weight [kg]:	6.650
Notation:	180° reversible
Tool drive:	Flat (~DIN 1809)
Shank size [mm]:	55.00
Shank type:	BMT
Tool adaption:	Polygon arbor 16

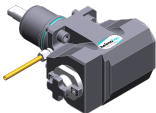
Part-#	Name	
		Gear ratio [i]: 1:1 Torque max [Nm]: 50 Rotation max [1/min]: 6000 Rotating direction: opposite Coolant: EXT Please note: Combi bearing Center distance [mm]: 65
<b>8 031 56 010</b>	<b>Radial polygon head arbor 27</b>	
		Notation: 180° reversible Tool drive: Flat (~DIN 1809) Shank size [mm]: 55.00 Shank type: BMT Tool adaption: Polygon arbor 27 Gear ratio [i]: 1:1 Torque max [Nm]: 50 Rotation max [1/min]: 6000 Rotating direction: opposite Coolant: EXT Please note: Combi bearing Center distance [mm]: 65
<b>8 031 56 012</b>	<b>Radial milling head universal arbor 27</b>	
		Weight [kg]: 6.560 Notation: 180° reversible Tool drive: Flat (~DIN 1809) Shank size [mm]: 55.00 Shank type: BMT Tool adaption: Universal arbor 27 Gear ratio [i]: 1:1 Torque max [Nm]: 50 Rotation max [1/min]: 6000 Rotating direction: opposite Coolant: EXT Please note: Combi bearing Center distance [mm]: 65
<b>8 031 56 022</b>	<b>Radial milling head universal arbor 27</b>	
		Notation: 180° reversible Tool drive: Flat (~DIN 1809) Shank size [mm]: 55.00 Shank type: BMT Tool adaption: Universal arbor 27 Gear ratio [i]: 2:1 Torque max [Nm]: 63 Rotation max [1/min]: 3000 Rotating direction: opposite Coolant: EXT Please note: Combi bearing Center distance [mm]: 65

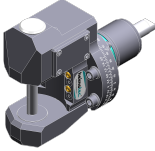
Part-#	Name		
	<b>8 031 56 026</b>	<b>Radial milling head arbor 27</b>	
		Notation:	180° reversible
		Tool drive:	Flat (~DIN 1809)
		Shank size [mm]:	55.00
		Shank type:	BMT
		Tool adaption:	Arbor 27
		Gear ratio [i]:	2:1
		Torque max [Nm]:	63
		Rotation max [1/min]:	3000
		Rotating direction:	opposite
		Coolant:	EXT
		Please note:	Combi bearing
		Center distance [mm]:	65
8 037 52 000	<b>Woodruff keycutter for disk mill arbor 10</b>		
		Tool drive:	Flat (~DIN 1809)
		Shank size [mm]:	55.00
		Shank type:	BMT
		Tool adaption:	Arbor 10
		Gear ratio [i]:	1,333:1
		Torque max [Nm]:	32
		Rotation max [1/min]:	2250
8 037 52 002	<b>Radial disk mill head arbor 10</b>		
		Weight [kg]:	6.900
		Tool drive:	Flat (~DIN 1809)
		Shank size [mm]:	55.00
		Shank type:	BMT
		Tool adaption:	Arbor 10
		Gear ratio [i]:	2:1
		Torque max [Nm]:	32
		Rotation max [1/min]:	3000
		Rotating direction:	opposite
		Coolant:	no
		Center distance [mm]:	76
8 037 53 001	<b>Radial disk mill head arbor 13</b>		
		Weight [kg]:	6.960
		Tool drive:	Flat (~DIN 1809)
		Shank size [mm]:	55.00
		Shank type:	BMT
		Tool adaption:	Arbor 13
		Gear ratio [i]:	2:1
		Torque max [Nm]:	32
		Rotation max [1/min]:	3000
		Rotating direction:	opposite
	Coolant:	no	
	Center distance [mm]:	76	

Part-#	Name	
	<b>8 037 53 007</b>	<b>Radial disk mill head arbor 1/2"</b>
	Weight [kg]:	6.750
	Version:	360° turnable
	Tool drive:	Flat (~DIN 1809)
	Shank size [mm]:	55.00
	Shank type:	BMT
	Tool adaption:	Arbor 1/2" (12,7mm)
	Gear ratio [i]:	1:1
	Torque max [Nm]:	50
	Rotation max [1/min]:	4000
	Rotating direction:	opposite
	Coolant:	EXT
	Center distance [mm]:	90
	<b>8 039 54 035</b>	<b>Radial drilling and milling head ER 16 AX UT IC</b>
	Weight [kg]:	4.980
	Notation:	180° reversible; 35° angle
	Tool drive:	Flat (~DIN 1809)
	Shank size [mm]:	55.00
	Shank type:	BMT
	Tool adaption:	ER 16 A - u-tec
	Gear ratio [i]:	1:1
	Torque max [Nm]:	40
	Rotation max [1/min]:	6000
	Rotating direction:	opposite
	Coolant:	IC/Ext
	Pressure max [bar]:	140
	<b>8 040 53 000</b>	<b>Universal head ± 90° adjustable ER 11 AX</b>
	Weight [kg]:	3.150
	Tool drive:	Flat (~DIN 1809)
	Shank size [mm]:	55.00
	Shank type:	BMT
	Tool adaption:	ER 11 A
	Gear ratio [i]:	1:1
	Torque max [Nm]:	10
	Rotation max [1/min]:	5000
	Rotating direction:	same
	Coolant:	EXT
	Center distance [mm]:	57
		<b>8 040 53 001</b>
Weight [kg]:		2.900
Tool drive:		Flat (~DIN 1809)
Shank size [mm]:		55.00
Shank type:		BMT
Tool adaption:		ER 11 A
Gear ratio [i]:		1:1
Torque max [Nm]:		10
Rotation max [1/min]:		6000
Rotating direction:		same
Coolant:		EXT
Center distance [mm]:		57

Part-#	Name	
<b>8 040 53 002</b>	<b>Universal head ± 90° adjustable ER 11 AX</b>	
	Weight [kg]:	2.880
	Tool drive:	Flat (~DIN 1809)
	Shank size [mm]:	55.00
	Shank type:	BMT
	Tool adaption:	ER 11 A
	Gear ratio [i]:	1:1
	Torque max [Nm]:	10
	Rotation max [1/min]:	6000
	Rotating direction:	same
	Coolant:	EXT
<b>8 040 53 003</b>	<b>Universal head ± 90° adjustable ER 11 AX</b>	
	Weight [kg]:	3.160
	Tool drive:	Flat (~DIN 1809)
	Shank size [mm]:	55.00
	Shank type:	BMT
	Tool adaption:	ER 11 A
	Gear ratio [i]:	1:1
	Torque max [Nm]:	10
	Rotation max [1/min]:	6000
	Rotating direction:	same
	Coolant:	EXT
	Center distance [mm]:	57
<b>8 040 54 002</b>	<b>Universal head ± 90° adjustable ER 16</b>	
	Weight [kg]:	3.180
	Tool drive:	Flat (~DIN 1809)
	Shank size [mm]:	55.00
	Shank type:	BMT
	Tool adaption:	ER 16
	Gear ratio [i]:	1:1
	Torque max [Nm]:	10
	Rotation max [1/min]:	6000
	Rotating direction:	same
	Coolant:	EXT
	Center distance [mm]:	57
<b>8 040 54 006</b>	<b>Universal head ± 90° adjustable ER 16</b>	
	Weight [kg]:	3.180
	Tool drive:	Flat (~DIN 1809)
	Shank size [mm]:	55.00
	Shank type:	BMT
	Tool adaption:	ER 16
	Gear ratio [i]:	1:1
	Torque max [Nm]:	10
	Rotation max [1/min]:	6000
	Rotating direction:	same
	Coolant:	EXT
	Center distance [mm]:	57

Part-#	Name	
<b>8 040 54 007</b>	<b>Universal head ± 90° adjustable ER 16</b>	
	Weight [kg]:	3.180
	Tool drive:	Flat (~DIN 1809)
	Shank size [mm]:	55.00
	Shank type:	BMT
	Tool adaption:	ER 16
	Gear ratio [i]:	1:1
	Torque max [Nm]:	10
	Rotation max [1/min]:	6000
	Rotating direction:	same
	Coolant:	EXT
	Center distance [mm]:	57
<b>8 040 54 008</b>	<b>Universal head ± 90° adjustable ER 16</b>	
	Weight [kg]:	3.180
	Tool drive:	Flat (~DIN 1809)
	Shank size [mm]:	55.00
	Shank type:	BMT
	Tool adaption:	ER 16
	Gear ratio [i]:	1:1
	Torque max [Nm]:	10
	Rotation max [1/min]:	6000
	Rotating direction:	same
	Coolant:	EXT
	Center distance [mm]:	57
<b>8 040 54 009</b>	<b>Universal head ± 90° adjustable ER 16</b>	
	Version:	Special
	Tool drive:	Flat (~DIN 1809)
	Shank size [mm]:	55.00
	Shank type:	BMT
	Tool adaption:	ER 16
	Gear ratio [i]:	1:1
	Torque max [Nm]:	10
	Rotation max [1/min]:	6000
	Rotating direction:	same
	Coolant:	EXT
	Center distance [mm]:	57
<b>8 040 54 012</b>	<b>Universal head ± 90° adjustable HT 2</b>	
	Version:	75° position can be pinned
	Tool drive:	Flat (~DIN 1809)
	Shank size [mm]:	55.00
	Shank type:	BMT
	Tool adaption:	HT 2
	Gear ratio [i]:	1:1
	Torque max [Nm]:	10
	Rotation max [1/min]:	6000
	Rotating direction:	same
	Coolant:	EXT
	Center distance [mm]:	57

Nakamura  
AS-200 - 12 Stationen

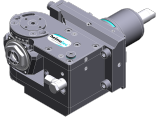
Part-#	Name	
<b>8 040 54 033</b>	<b>Universal head ± 90° adjustable ER 16 AS UT IC</b>	
	Weight [kg]:	3.320
	Tool drive:	Flat (~DIN 1809)
	Shank size [mm]:	55.00
	Shank type:	BMT
	Tool adaption:	ER 16 A - u-tec
	Gear ratio [i]:	1:1
	Torque max [Nm]:	16
	Rotation max [1/min]:	12000
	Rotating direction:	same
	Coolant:	IC/Ext
	Pressure max [bar]:	140
	Please note:	Check applicability; note center distance!
	Center distance [mm]:	46
<b>8 043 54 000</b>	<b>Universal head +135°/-30° adj. ER16 AX UT</b>	
	Weight [kg]:	9.850
	Notation:	offset; 180° reversible
	Tool drive:	Flat (~DIN 1809)
	Shank size [mm]:	55.00
	Shank type:	BMT
	Tool adaption:	ER 16 A - u-tec
	Gear ratio [i]:	1:1
	Torque max [Nm]:	25
	Rotation max [1/min]:	6000
	Rotating direction:	same
	Coolant:	EXT
	Center distance [mm]:	69
	Offset [mm]:	60
<b>8 043 54 001</b>	<b>Universal head +135°/-30° adj. ER16AX UTIK</b>	
	Weight [kg]:	9.920
	Notation:	offset; 180° reversible
	Tool drive:	Flat (~DIN 1809)
	Shank size [mm]:	55.00
	Shank type:	BMT
	Tool adaption:	ER 16 A - u-tec
	Gear ratio [i]:	1:1
	Torque max [Nm]:	25
	Rotation max [1/min]:	6000
	Rotating direction:	same
	Coolant:	IC/Ext
	Pressure max [bar]:	140
	Center distance [mm]:	69
	Offset [mm]:	60
<b>8 043 54 002</b>	<b>Universal head +135°/-30° adj. ER16 AX UT</b>	
	Weight [kg]:	9.930
	Notation:	offset; 180° reversible
	Tool drive:	Flat (~DIN 1809)
	Shank size [mm]:	55.00
	Shank type:	BMT
	Tool adaption:	ER 16 A - u-tec
	Gear ratio [i]:	1:2
	Torque max [Nm]:	12
	Rotation max [1/min]:	12000
	Rotating direction:	same

Part-#	Name	
	Coolant:	EXT
	Center distance [mm]:	69
	Offset [mm]:	60
<b>8 043 54 003</b>	<b>Universal head +135°/-30° adj. ER16AX UTIK</b>	
	Weight [kg]:	9.900
	Notation:	offset
	Tool drive:	Flat (~DIN 1809)
	Shank size [mm]:	55.00
	Shank type:	BMT
	Tool adaption:	ER 16 A - u-tec
	Gear ratio [i]:	1:2
	Torque max [Nm]:	12
	Rotation max [1/min]:	12000
	Rotating direction:	same
	Coolant:	IC/Ext
	Pressure max [bar]:	140
	Please note:	180° reversible
	Center distance [mm]:	69
	Offset [mm]:	60
<b>8 043 54 004</b>	<b>Universal head +135°/-30° adj. ER20 AX UT</b>	
	Weight [kg]:	10.010
	Notation:	offset; 180° reversible
	Tool drive:	Flat (~DIN 1809)
	Shank size [mm]:	55.00
	Shank type:	BMT
	Tool adaption:	ER 20 A - u-tec
	Gear ratio [i]:	1:1
	Torque max [Nm]:	25
	Rotation max [1/min]:	6000
	Rotating direction:	same
	Coolant:	EXT
	Please note:	stronger bearing
	Center distance [mm]:	69
	Offset [mm]:	60
<b>8 043 54 019</b>	<b>Universal head +160°/-20° adj. ER16 AX UT</b>	
	Weight [kg]:	6.100
	Notation:	offset; 180° reversible
	Tool drive:	Flat (~DIN 1809)
	Shank size [mm]:	55.00
	Shank type:	BMT
	Tool adaption:	ER 16 A - u-tec
	Gear ratio [i]:	1:1
	Torque max [Nm]:	25
	Rotation max [1/min]:	6000
	Rotating direction:	same
	Coolant:	EXT
	Center distance [mm]:	35
	Offset [mm]:	65

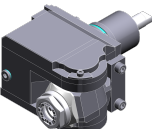
Part-#	Name	
<b>8 043 54 034</b>	<b>Universal head ± 10° adjustable ER 16 AX UT IC</b>	
	Notation:	offset; 180° reversible
	Tool drive:	Flat (~DIN 1809)
	Shank size [mm]:	55.00
	Shank type:	BMT
	Tool adaption:	ER 16 A - u-tec
	Gear ratio [i]:	1:2
	Torque max [Nm]:	25
	Rotation max [1/min]:	12000
	Rotating direction:	same
	Coolant:	IC/Ext
	Pressure max [bar]:	140
	Please note:	Check applicability! note swivel range;
	Center distance [mm]:	62
	Offset [mm]:	48,5
<b>8 043 55 001</b>	<b>Universal head +135°/-30° adj. ER25 AX UT</b>	
	Weight [kg]:	10.060
	Notation:	offset; 180° reversible
	Tool drive:	Flat (~DIN 1809)
	Shank size [mm]:	55.00
	Shank type:	BMT
	Tool adaption:	ER 25 A - u-tec
	Gear ratio [i]:	1:1
	Torque max [Nm]:	25
	Rotation max [1/min]:	6000
	Rotating direction:	same
	Coolant:	EXT
	Please note:	stronger bearing
	Center distance [mm]:	69
	Offset [mm]:	60
<b>8 043 55 021</b>	<b>Universal head +150°/-15° adj. ER25 AX UT</b>	
	Weight [kg]:	6.410
	Notation:	offset; 180° reversible
	Version:	at 55° position can be pinned
	Tool drive:	Flat (~DIN 1809)
	Shank size [mm]:	55.00
	Shank type:	BMT
	Tool adaption:	ER 25 A - u-tec
	Gear ratio [i]:	1:1
	Torque max [Nm]:	25
	Rotation max [1/min]:	6000
	Rotating direction:	opposite
	Coolant:	EXT
	Please note:	stronger bearing
	Center distance [mm]:	35
	Offset [mm]:	65
<b>8 043 55 022</b>	<b>Universal head +135°/-30° adj. ER25AX UTIK</b>	
	Weight [kg]:	10.080
	Notation:	offset; 180° reversible
	Tool drive:	Flat (~DIN 1809)
	Shank size [mm]:	55.00
	Shank type:	BMT
	Tool adaption:	ER 25 A - u-tec
	Gear ratio [i]:	1:1

Part-#	Name	
	Torque max [Nm]:	25
	Rotation max [1/min]:	6000
	Rotating direction:	same
	Coolant:	IC/Ext
	Pressure max [bar]:	140
	Please note:	stronger bearing
	Center distance [mm]:	69
	Offset [mm]:	60
<b>8 050 54 005</b>	<b>Multispindle drilling head ER 16 AX UT</b>	
	Weight [kg]:	6.100
	Notation:	offset
	Version:	2-spindles
	Tool drive:	Flat (~DIN 1809)
	Shank size [mm]:	55.00
	Shank type:	BMT
	Tool adaption:	ER 16 A - u-tec
	Gear ratio [i]:	1:2
	Torque max [Nm]:	16
	Rotation max [1/min]:	12000
	Rotating direction:	same
	Coolant:	EXT
	Offset [mm]:	56
<b>8 050 54 008</b>	<b>Multispindle drilling head ER 16 AX UT</b>	
	Weight [kg]:	5.700
	Notation:	offset
	Version:	2-spindles
	Tool drive:	Flat (~DIN 1809)
	Shank size [mm]:	55.00
	Tool adaption:	ER 16 A - u-tec
	Gear ratio [i]:	1:1
	Torque max [Nm]:	25
	Rotation max [1/min]:	6000
	Rotating direction:	same
	Coolant:	EXT
<b>8 050 54 014</b>	<b>Multispindle drilling head ER 20 AX UT IC</b>	
	Weight [kg]:	5.920
	Notation:	offset
	Version:	2-spindles
	Tool drive:	Flat (~DIN 1809)
	Shank size [mm]:	55.00
	Shank type:	BMT
	Tool adaption:	ER 20 A - u-tec
	Gear ratio [i]:	1:1
	Torque max [Nm]:	25
	Rotation max [1/min]:	6000
	Rotating direction:	same
	Coolant:	IC/Ext
	Pressure max [bar]:	140
	Offset [mm]:	58

Part-#	Name	
<b>8 050 54 021</b>	<b>Multispindle drilling head ER 16 AX UT IC</b>	
	Weight [kg]:	6.110
	Notation:	offset; 180° reversible
	Version:	2-spindles
	Tool drive:	Flat (~DIN 1809)
	Shank size [mm]:	55.00
	Shank type:	BMT
	Tool adaption:	ER 16 A - u-tec
	Gear ratio [i]:	1:2
	Torque max [Nm]:	16
	Rotation max [1/min]:	12000
	Rotating direction:	same
	Coolant:	IC/Ext
	Pressure max [bar]:	25
	Offset [mm]:	56
<b>8 050 54 036</b>	<b>Multispindle drilling head ER 16 AX UT IC</b>	
	Weight [kg]:	6.040
	Notation:	offset; 180° reversible
	Version:	3-spindles
	Tool drive:	Flat (~DIN 1809)
	Shank size [mm]:	55.00
	Shank type:	BMT
	Tool adaption:	ER 16 A - u-tec
	Gear ratio [i]:	1:1
	Torque max [Nm]:	25
	Rotation max [1/min]:	6000
	Rotating direction:	same
	Coolant:	IC/Ext
	Pressure max [bar]:	140
	Please note:	2x ER 16 A offset, 1x centered, IC only in 2 x
	Offset [mm]:	56
<b>8 050 54 037</b>	<b>Multispindle drilling head ER 16 AX UT</b>	
	Weight [kg]:	6.900
	Notation:	offset; 180° reversible
	Employment for:	Main- and sub spindle
	Tool drive:	Flat (~DIN 1809)
	Shank size [mm]:	55.00
	Shank type:	BMT
	Tool adaption:	ER 16 A - u-tec
	Gear ratio [i]:	1:1
	Torque max [Nm]:	16/Sp.
	Rotation max [1/min]:	6000
	Rotating direction:	opposite
	Coolant:	no
	Please note:	stronger bearing
	Offset [mm]:	+38,1/-38,1
<b>8 050 54 038</b>	<b>Multispindle drilling head ER 16 AX UT</b>	
	Weight [kg]:	6.870
	Notation:	offset; 180° reversible
	Employment for:	Main- and sub spindle
	Tool drive:	Flat (~DIN 1809)
	Shank size [mm]:	55.00
	Shank type:	BMT
	Tool adaption:	ER 16 A - u-tec
	Gear ratio [i]:	1:1

Part-#

Name

Torque max [Nm]: 16/Sp.  
 Rotation max [1/min]: 6000  
 Rotating direction: opposite  
 Coolant: EXT  
 Please note: stronger bearing  
 Offset [mm]: +38,1/-38,1

8 053 54 045

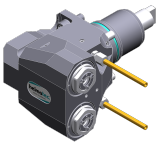
**Multispindle radial head ER 16 AX UT**

Weight [kg]: 6.850  
 Notation: 180° reversible  
 Version: 2-spindles  
 Tool drive: Flat (~DIN 1809)  
 Shank size [mm]: 55.00  
 Shank type: BMT  
 Tool adaption: ER 16 A - u-tec  
 Gear ratio [i]: 1:1  
 Torque max [Nm]: 32/Sp  
 Rotation max [1/min]: 12000  
 Rotating direction: same  
 Coolant: EXT  
 Center distance [mm]: 75

8 053 54 046

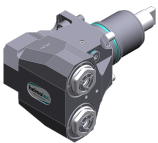

**Multispindle radial head ER 16 AX UTIK**

Notation: 180° reversible  
 Version: 2-spindles  
 Tool drive: Flat (~DIN 1809)  
 Shank size [mm]: 55.00  
 Shank type: BMT  
 Tool adaption: ER 16 A - u-tec  
 Gear ratio [i]: 1:1  
 Torque max [Nm]: 32/Sp  
 Rotation max [1/min]: 12000  
 Rotating direction: same  
 Coolant: IC/Ext  
 Pressure max [bar]: 140  
 Center distance [mm]: 75

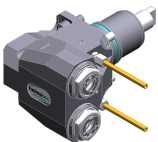
8 053 54 047

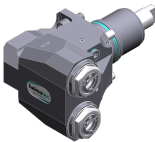

**Multispindle radial head ER 20 AX UT**

Notation: 180° reversible  
 Version: 2-spindles  
 Tool drive: Flat (~DIN 1809)  
 Shank size [mm]: 55.00  
 Shank type: BMT  
 Tool adaption: ER 20 A - u-tec  
 Gear ratio [i]: 1:1  
 Torque max [Nm]: 32/Sp  
 Rotation max [1/min]: 12000  
 Rotating direction: same  
 Coolant: EXT  
 Center distance [mm]: 75

Part-#	Name	
8 053 54 048	<b>Multispindle radial head ER 20 AX UTIK</b>	
		<p>Notation: 180° reversible Version: 2-spindles Tool drive: Flat (~DIN 1809) Shank size [mm]: 55.00 Shank type: BMT Tool adaption: ER 20 A - u-tec Gear ratio [i]: 1:1 Torque max [Nm]: 32/Sp Rotation max [1/min]: 12000 Rotating direction: same Coolant: IC/Ext Pressure max [bar]: 140 Center distance [mm]: 75</p>
8 068 54 000	<b>Radial whirling unit HW 46</b>	
		<p>Notation: 180° reversible Tool drive: Flat (~DIN 1809) Shank size [mm]: 55.00 Shank type: BMT Tool adaption: HW 46 Gear ratio [i]: 1:1 Torque max [Nm]: 16 Rotation max [1/min]: 8000 Rotating direction: same Coolant: EXT Please note: without cutting inserts carrier; check applicability; Center distance [mm]: 65</p>
8 100 15 001	<b>Tool holder radial ø17,1 / minus</b>	
		<p>Employment for: Angle handpiece or extension CN01 Tool drive: Flat (~DIN 1809) Shank size [mm]: 55.00 Shank type: BMT Tool adaption: Interface ø17,1 / M17x1 Gear ratio [i]: 1:2 Rotation max [1/min]: 12000 Rotating direction: same Coolant: no Center distance [mm]: 77</p>
8 102 15 000	<b>Tool holder Ø 17</b>	
		<p>Weight [kg]: 1.930 Employment for: Angle handpiece Tool drive: Flat (~DIN 1809) Shank size [mm]: 55.00 Shank type: BMT Tool adaption: Interface 17 Gear ratio [i]: 1:1 Rotation max [1/min]: 6000 Rotating direction: same Coolant: no</p>

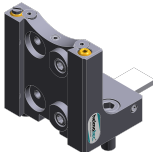

Part-#	Name	
<b>8 200 03 002</b>	<b>Cover plate</b>	
	Weight [kg]:	0.300
	Shank type:	BMT
<b>8 200 10 002</b>	<b>Tool blank</b>	
	Weight [kg]:	4.190
	Notation:	180° reversible
	Shank type:	BMT
	Machine adaption:	Centering key b 20
	Please note:	Housing rigid
<b>8 202 10 006</b>	<b>Basic holder longitudinal seat FN 12</b>	
	Weight [kg]:	0.960
	Notation:	180° reversible
	Shank type:	BMT
	Machine adaption:	Centering key b 20
	Tool adaption:	Interface FN 12
	Coolant:	EXT
<b>8 209 10 000</b>	<b>Tool blank</b>	
	Weight [kg]:	4.580
	Shank type:	BMT
	Machine adaption:	Centering key b 20
	Coolant:	EXT
<b>8 209 14 002</b>	<b>Adapter for VDI 40</b>	
	Weight [kg]:	2.720
	Shank type:	BMT
	Machine adaption:	Centering key b 20
	Tool adaption:	DIN 69880 - 40
	Coolant:	EXT
	Center distance [mm]:	35
<b>8 209 14 003</b>	<b>Adapter for VDI 40 offset</b>	
	Shank type:	BMT
	Machine adaption:	Centering key b 20
	Tool adaption:	DIN 69880 - 40
	Coolant:	EXT
	Center distance [mm]:	65
<b>8 224 11 002</b>	<b>Turning holder sq. 20</b>	
	Weight [kg]:	2.420
	Employment for:	right cutting tools
	Shank type:	BMT
	Machine adaption:	Centering key b 20
	Tool adaption:	Sq. 20
	Coolant:	EXT

Part-#	Name	
<b>8 224 11 003</b>	<b>Cut-off holder sq. 20</b>	
	Weight [kg]:	1.040
	Employment for:	right cutting tools
	Version:	Edge on side of turret
	Shank type:	BMT
	Machine adaption:	Centering key b 20
	Tool adaption:	Sq. 20
	Coolant:	EXT
<b>8 224 11 005</b>	<b>Cut-off holder sq. 20</b>	
	Weight [kg]:	1.100
	Employment for:	left cutting tools
	Version:	Edge on center of turret
	Shank type:	BMT
	Machine adaption:	Centering key b 20
	Tool adaption:	Sq. 20
	Coolant:	EXT
<b>8 224 11 016</b>	<b>Cut-off holder sq. 3/4" R 1441</b>	
	Weight [kg]:	1.110
	Employment for:	right cutting tools
	Version:	Edge on side of turret
	Shank type:	BMT
	Machine adaption:	Centering key b 20
	Tool adaption:	Sq. 3/4" (19,05mm)
	Coolant:	EXT
<b>8 224 11 022</b>	<b>Cut-off holder sq. 20</b>	
	Weight [kg]:	1.350
	Employment for:	right cutting tools
	Version:	Edge on side of turret
	Shank type:	BMT
	Machine adaption:	Centering key b 20
	Tool adaption:	Sq. 20
	Coolant:	EXT
<b>8 224 12 005</b>	<b>Cut-off holder sq. 25</b>	
	Weight [kg]:	1.480
	Shank type:	BMT
	Machine adaption:	Centering key b 20
	Tool adaption:	Sq. 25
	Coolant:	EXT
<b>8 224 12 006</b>	<b>Cut-off holder sq. 25</b>	
	Weight [kg]:	1.480
	Employment for:	left cutting tools
	Version:	Edge on center of turret
	Shank type:	BMT
	Machine adaption:	Centering key b 20
	Tool adaption:	Sq. 25
	Coolant:	EXT

Part-#	Name	
<b>8 224 13 004</b>	<b>Cut-off holder SH 32</b>	
	Weight [kg]:	1.000
	Employment for:	Cut-off tool 32
	Version:	Clampshaft on turret center
	Shank type:	BMT
	Machine adaption:	Centering key b 20
	Tool adaption:	Clampshaft SH 32
	Coolant:	EXT
<b>8 224 13 007</b>	<b>Cut-off holder SH 32</b>	
	Weight [kg]:	1.190
	Employment for:	Cut-off tool 32
	Version:	Clampshaft on turret side
	Shank type:	BMT
	Machine adaption:	Centering key b 20
	Tool adaption:	Clampshaft SH 32
	Coolant:	EXT
<b>8 224 13 013</b>	<b>Cut-off holder SH 32</b>	
	Weight [kg]:	1.480
	Employment for:	Cut-off tool 32
	Version:	Clampshaft on turret side
	Shank type:	BMT
	Machine adaption:	Centering key b 20
	Tool adaption:	Clampshaft SH 32
	Coolant:	EXT
	Please note:	Special
<b>8 224 13 021</b>	<b>Cut-off holder SH 32 IC</b>	
	Weight [kg]:	1.030
	Employment for:	Cut-off tool 32
	Version:	Clampshaft on turret center
	Shank type:	BMT
	Machine adaption:	Centering key b 20
	Tool adaption:	Clampshaft SH 32
	Coolant:	IC/Ext
<b>8 224 14 000</b>	<b>Universal turning holder sq. 20</b>	
	Weight [kg]:	1.730
	Notation:	180° reversible
	Shank type:	BMT
	Machine adaption:	Centering key b 20
	Tool adaption:	Sq. 20
		Sq. 20
	Coolant:	EXT
	Please note:	with spacer strip
<b>8 224 14 016</b>	<b>Universal turning holder sq. 20 IC</b>	
	Weight [kg]:	2.950
	Notation:	180° reversible
	Shank type:	BMT
	Machine adaption:	Centering key b 20
	Tool adaption:	Sq. 20
	Coolant:	IC/Ext
	Pressure max [bar]:	100
	Please note:	Key rail

Part-#	Name	
8 224 15 002	<b>Universal turning holder sq. 25/20</b> 	Weight [kg]: 2.800
		Notation: 180° reversible
8 224 15 012	<b>Universal turning holder sq. 1"</b>	Shank type: BMT
		Machine adaption: Centering key b 20
		Tool adaption: Sq. 25
		Sq. 25
		Coolant: EXT
		Please note: With spacer strip for sq. 20
		Weight [kg]: 2.720
		Shank type: BMT
		Machine adaption: Centering key b 20
		Tool adaption: Sq. 1" (25,4mm)
Sq. 1" (25,4mm)		
Coolant: EXT		
8 224 15 046	<b>Universal turning holder sq. 25/20</b>	Weight [kg]: 5.520
		Shank type: BMT
		Machine adaption: Centering key b 20
		Tool adaption: Sq. 25
		Sq. 25
		Coolant: EXT
		Please note: Check applicability! with spacer strip for
		Weight [kg]: 3.100
		Shank type: BMT
		Machine adaption: Centering key b 20
8 224 15 062	<b>Universal turning holder sq. 25 IC</b> 	Tool adaption: Sq. 25
		Sq. 25
		Coolant: IC/Ext
		Pressure max [bar]: 100
		Please note: Key rail
		Weight [kg]: 3.100
8 224 15 063	<b>Universal turning holder sq. 1" IC</b> 	Shank type: BMT
		Machine adaption: Centering key b 20
		Tool adaption: Sq. 1" (25,4mm)
		Sq. 1" (25,4mm)
		Coolant: IC/Ext
		Pressure max [bar]: 100
Please note: Key rail		
8 225 11 002	<b>Cut-off holder sq. 20 R 1432</b>	Weight [kg]: 1.120
		Employment for: left cutting tools
		Version: Edge on side of turret
		Shank type: BMT
		Machine adaption: Centering key b 20
		Tool adaption: Sq. 20
		Coolant: EXT

Part-#	Name	
<b>8 225 11 005</b>	<b>Cut-off holder sq. 20</b>	
	Weight [kg]:	1.170
	Employment for:	right cutting tools
	Version:	Edge on center of turret
	Shank type:	BMT
	Machine adaption:	Centering key b 20
	Tool adaption:	Sq. 20
	Coolant:	EXT
<b>8 225 11 009</b>	<b>Cut-off holder sq. 3/4" R 1442</b>	
	Weight [kg]:	1.110
	Employment for:	left cutting tools
	Version:	Edge on side of turret
	Shank type:	BMT
	Machine adaption:	Centering key b 20
	Tool adaption:	Sq. 3/4" (19,05mm)
	Coolant:	EXT
<b>8 225 11 012</b>	<b>Cut-off holder sq. 3/4"</b>	
	Weight [kg]:	1.200
	Employment for:	right cutting tools
	Version:	Edge on center of turret
	Shank type:	BMT
	Machine adaption:	Centering key b 20
	Tool adaption:	Sq. 3/4" (19,05mm)
	Coolant:	EXT
<b>8 229 16 001</b>	<b>Tool holder C 4 IC</b>	
	Weight [kg]:	2.400
	Notation:	180° reversible
	Version:	right
	Shank type:	BMT
	Machine adaption:	Centering key b 20
	Tool adaption:	heimatec Capto(TM) C 4
	Coolant:	IC/Ext
	Please note:	Check applicability; note tool length!
	Offset [mm]:	12
<b>8 229 16 003</b>	<b>Tool holder C 4 IC</b>	
	Weight [kg]:	3.330
	Notation:	180° reversible
	Version:	right
	Shank type:	BMT
	Machine adaption:	Centering key b 20
	Tool adaption:	heimatec Capto(TM) C 4
	Coolant:	IC/Ext
	Please note:	Check applicability; note tool length!
	Offset [mm]:	55
<b>8 229 16 008</b>	<b>Tool holder C 4 IC</b>	
	Weight [kg]:	3.430
	Notation:	180° reversible
	Version:	right
	Shank type:	BMT
	Machine adaption:	Centering key b 20
	Tool adaption:	heimatec Capto(TM) C 4
	Coolant:	IC
	Please note:	Check applicability; note tool length!



Part-#	Name	
	Offset [mm]:	55
<b>8 229 16 009</b>	<b>Tool holder C 4 IC</b>	
	Weight [kg]:	2.410
	Notation:	180° reversible
	Version:	right
	Shank type:	BMT
	Machine adaption:	Centering key b 20
	Tool adaption:	heimatec Capto(TM) C 4
	Coolant:	IC
	Please note:	Check applicability; note tool length!
	Offset [mm]:	12
<b>8 229 16 011</b>	<b>Tool holder C 4 IC</b>	
	Weight [kg]:	3.440
	Notation:	180° reversible
	Version:	left
	Shank type:	BMT
	Machine adaption:	Centering key b 20
	Tool adaption:	heimatec Capto(TM) C 4
	Coolant:	IC
	Please note:	Check applicability; note tool length!
	Offset [mm]:	55
<b>8 240 14 017</b>	<b>Boring bar holder Ø 12 - slotted</b>	
	Weight [kg]:	2.900
	Notation:	180° reversible
	Version:	slotted
	Shank type:	BMT
	Machine adaption:	Centering key b 20
	Tool adaption:	Ø 12
	Coolant:	EXT
	Pressure max [bar]:	100
	Center distance [mm]:	75
<b>8 240 14 022</b>	<b>Boring bar holder Ø 10 - slotted</b>	
	Weight [kg]:	2.900
	Notation:	180° reversible
	Version:	slotted
	Shank type:	BMT
	Machine adaption:	Centering key b 20
	Tool adaption:	Ø 10
	Coolant:	EXT
	Pressure max [bar]:	100
	Center distance [mm]:	75
<b>8 240 15 003</b>	<b>Boring bar holder Ø 16 DIN 1835 E</b>	
	Weight [kg]:	3.020
	Shank type:	BMT
	Machine adaption:	Centering key b 20
	Tool adaption:	Whistle-Notch (DIN 1835 E) 16
	Coolant:	IC/Ext
	Center distance [mm]:	75

Part-#	Name	
<b>8 240 15 004</b>	<b>Tool holder C 3 IC</b>	
	Weight [kg]:	3.580
	Notation:	180° reversible; offset
	Shank type:	BMT
	Machine adaption:	Centering key b 20
	Tool adaption:	heimatec Capto(TM) C 3
	Coolant:	IC
	Center distance [mm]:	75
<b>8 240 15 006</b>	<b>Collet chuck holder ER 25</b>	
	Weight [kg]:	3.520
	Notation:	180° reversible
	Shank type:	BMT
	Machine adaption:	Centering key b 20
	Tool adaption:	ER 25
	Coolant:	IC/Ext
	Please note:	Insert reversible
	Center distance [mm]:	75
<b>8 240 15 007</b>	<b>Insert drill holder 16 IC</b>	
	Weight [kg]:	4.540
	Notation:	180° reversible
	Shank type:	BMT
	Tool adaption:	Whistle-Notch (DIN 1835 E) 16
	Coolant:	IC
	Center distance [mm]:	75
<b>8 240 15 019</b>	<b>Collet chuck holder ER 25 AX UT IC</b>	
	Weight [kg]:	3.380
	Notation:	180° reversible; offset
	Shank type:	BMT
	Machine adaption:	Centering key b 20
	Tool adaption:	ER 25 A - u-tec
	Coolant:	IC/Ext
	Center distance [mm]:	75
<b>8 240 15 039</b>	<b>Boring bar holder Ø 16 - slotted</b>	
	Weight [kg]:	3.000
	Notation:	180° reversible
	Shank type:	BMT
	Machine adaption:	Centering key b 20
	Tool adaption:	Ø 16
	Coolant:	EXT
	Center distance [mm]:	75
<b>8 240 16 001</b>	<b>Boring bar holder Ø 20 DIN 1835 E</b>	
	Weight [kg]:	2.960
	Shank type:	BMT
	Machine adaption:	Centering key b 20
	Tool adaption:	Whistle-Notch (DIN 1835 E) 20
	Coolant:	IC
	Center distance [mm]:	75

Nakamura  
AS-200 - 12 Stationen

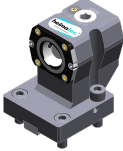
Part-#	Name	
<b>8 240 16 004</b>	<b>Tool holder HT 4 IC</b>	
	Weight [kg]:	2.890
	Notation:	180° reversible; offset
	Shank type:	BMT
	Machine adaption:	Centering key b 20
	Tool adaption:	HT 4
	Coolant:	IC/Ext
	Center distance [mm]:	75
<b>8 240 16 005</b>	<b>Boring bar holder Ø 24</b>	
	Notation:	180° reversible
	Version:	Special
	Shank type:	BMT
	Machine adaption:	Centering key b 20
	Tool adaption:	Ø 24
	Coolant:	IC/Ext
	Please note:	Housing rigid
	Center distance [mm]:	75
<b>8 240 16 006</b>	<b>Tool holder HT 4 IC</b>	
	Weight [kg]:	3.340
	Notation:	offset
	Version:	Special
	Shank type:	BMT
	Machine adaption:	Centering key b 20
	Tool adaption:	HT 4
	Coolant:	IC/Ext
	Center distance [mm]:	75
<b>8 240 16 008</b>	<b>Collet chuck holder ER 32</b>	
	Weight [kg]:	3.200
	Notation:	180° reversible
	Shank type:	BMT
	Machine adaption:	Centering key b 20
	Tool adaption:	ER 32
	Coolant:	IC/Ext
	Please note:	Insert reversible
	Center distance [mm]:	75
<b>8 240 16 009</b>	<b>Insert drill holder 20 IC</b>	
	Weight [kg]:	4.480
	Notation:	180° reversible
	Shank type:	BMT
	Tool adaption:	Whistle-Notch (DIN 1835 E) 20
	Coolant:	IC
	Center distance [mm]:	75
<b>8 240 16 020</b>	<b>Tool holder HT 4 IC</b>	
	Weight [kg]:	5.900
	Notation:	offset; 180° reversible
	Version:	Special
	Shank type:	BMT
	Machine adaption:	Centering key b 20
	Tool adaption:	HT 4
	Coolant:	IC/Ext
	Center distance [mm]:	75

Part-#	Name	
<b>8 240 16 030</b>	<b>Boring bar holder Ø 20</b>	
	Weight [kg]:	3.940
	Notation:	180° reversible
	Shank type:	BMT
	Machine adaption:	Centering key b 20
	Tool adaption:	Ø 20
	Coolant:	IC/Ext
	Please note:	Housing rigid
	Center distance [mm]:	75
<b>8 240 16 034</b>	<b>Collet chuck holder ER 32</b>	
	Weight [kg]:	3.060
	Notation:	180° reversible; offset
	Shank type:	BMT
	Machine adaption:	Centering key b 20
	Tool adaption:	ER 32
	Coolant:	IC/Ext
	Center distance [mm]:	75
<b>8 240 16 040</b>	<b>Tool holder C 4 IC</b>	
	Weight [kg]:	3.130
	Notation:	180° reversible
	Version:	offset; right
	Shank type:	BMT
	Machine adaption:	Centering key b 20
	Tool adaption:	heimatec Capto(TM) C 4
	Coolant:	IC/Ext
	Please note:	Check applicability; note tool length!
	Center distance [mm]:	75
<b>8 240 16 045</b>	<b>Tool holder C 4 IC</b>	
	Weight [kg]:	2.960
	Notation:	180° reversible
	Version:	offset; right
	Shank type:	BMT
	Machine adaption:	Centering key b 20
	Tool adaption:	heimatec Capto(TM) C 4
	Coolant:	IC
	Please note:	Check applicability; note tool length!
	Center distance [mm]:	75
<b>8 240 16 046</b>	<b>Tool holder C 4 IC</b>	
	Weight [kg]:	3.480
	Notation:	180° reversible
	Version:	right
	Shank type:	BMT
	Machine adaption:	Centering key b 20
	Tool adaption:	heimatec Capto(TM) C 4
	Coolant:	IC
	Please note:	Check applicability; note tool length!
	Center distance [mm]:	75

Part-#	Name	
<b>8 240 16 051</b>	<b>Tool holder C 4 IC</b>	
	Weight [kg]:	3.430
	Notation:	180° reversible
	Version:	left
	Shank type:	BMT
	Machine adaption:	Centering key b 20
	Tool adaption:	heimatec Capto(TM) C 4
	Coolant:	IC
	Please note:	Check applicability; note tool length!
	Center distance [mm]:	75
<b>8 240 16 054</b>	<b>Tool holder C 4 IC</b>	
	Weight [kg]:	2.840
	Notation:	180° reversible
	Version:	left; special
	Shank type:	BMT
	Machine adaption:	Centering key b 20
	Tool adaption:	heimatec Capto(TM) C 4
	Coolant:	IC/Ext
	Please note:	Check applicability; note tool length!
	Center distance [mm]:	40
<b>8 240 16 077</b>	<b>Boring bar holder Ø 20 - slotted</b>	
	Weight [kg]:	3.120
	Notation:	180° reversible
	Version:	slotted
	Shank type:	BMT
	Machine adaption:	Centering key b 20
	Tool adaption:	Ø 20
	Coolant:	EXT
	Pressure max [bar]:	100
	Center distance [mm]:	75
<b>8 240 17 005</b>	<b>Boring bar holder Ø 25</b>	
	Weight [kg]:	3.820
	Notation:	180° reversible
	Shank type:	BMT
	Machine adaption:	Centering key b 20
	Tool adaption:	Ø 25
	Coolant:	IC/Ext
	Please note:	Housing rigid
	Center distance [mm]:	75
<b>8 240 17 007</b>	<b>Boring bar holder Ø 25</b>	
	Weight [kg]:	2.320
	Notation:	180° reversible
	Version:	offset
	Shank type:	BMT
	Machine adaption:	Centering key b 20
	Tool adaption:	Ø 25
	Coolant:	IC/Ext
	Please note:	Housing rigid
	Center distance [mm]:	75

Part-#	Name	
<b>8 240 17 008</b>	<b>Boring bar holder Ø 25 DIN 1835 E</b>	
	Weight [kg]:	3.210
	Notation:	offset; 180° reversible
	Version:	Special
	Shank type:	BMT
	Machine adaption:	Centering key b 20
	Tool adaption:	Whistle-Notch (DIN 1835 E) 25
	Coolant:	IC/Ext
	Center distance [mm]:	75
<b>8 240 17 011</b>	<b>Boring bar holder Ø 25,4 (1")</b>	
	Weight [kg]:	3.800
	Notation:	180° reversible
	Shank type:	BMT
	Machine adaption:	Centering key b 20
	Tool adaption:	Ø 1" (25,4mm)
	Coolant:	IC/Ext
	Pressure max [bar]:	140
	Please note:	Housing rigid
	Center distance [mm]:	75
<b>8 240 17 016</b>	<b>Boring bar holder Ø 30</b>	
	Notation:	180° reversible
	Version:	Special
	Shank type:	BMT
	Machine adaption:	Centering key b 20
	Tool adaption:	Ø 30
	Coolant:	IC/Ext
	Please note:	Housing rigid
	Center distance [mm]:	75
<b>8 240 17 021</b>	<b>Collet chuck holder ER 40</b>	
	Weight [kg]:	3.710
	Notation:	180° reversible
	Shank type:	BMT
	Machine adaption:	Centering key b 20
	Tool adaption:	ER 40
	Coolant:	IC/Ext
	Please note:	Insert reversible
	Center distance [mm]:	75
<b>8 240 17 023</b>	<b>Insert drill holder 25 IC</b>	
	Weight [kg]:	4.380
	Notation:	180° reversible
	Shank type:	BMT
	Tool adaption:	Whistle-Notch (DIN 1835 E) 25
	Coolant:	IC
	Center distance [mm]:	75
<b>8 240 17 031</b>	<b>Boring bar holder Ø 30</b>	
	Notation:	180° reversible
	Version:	Special
	Shank type:	BMT
	Machine adaption:	Centering key b 20
	Tool adaption:	Ø 30
	Coolant:	EXT
	Center distance [mm]:	112

Part-#	Name	
<b>8 240 17 032</b>	<b>Boring bar holder Ø 30</b>	
	Notation:	180° reversible
	Version:	Special
	Shank type:	BMT
	Machine adaption:	Centering key b 20
	Tool adaption:	Ø 30
	Coolant:	EXT
	Center distance [mm]:	105
<b>8 240 17 049</b>	<b>Boring bar holder Ø 1" offset</b>	
	Weight [kg]:	2.450
	Notation:	180° reversible
	Version:	offset
	Shank type:	BMT
	Machine adaption:	Centering key b 20
	Tool adaption:	Ø 1" (25,4mm)
	Coolant:	IC/Ext
	Please note:	Housing rigid
	Center distance [mm]:	75
<b>8 240 17 052</b>	<b>Boring bar holder Ø 25</b>	
	Weight [kg]:	4.430
	Employment for:	Main spindle
	Version:	long; special
	Shank type:	BMT
	Machine adaption:	Centering key b 20
	Tool adaption:	Ø 25
	Coolant:	IC/Ext
	Center distance [mm]:	75
<b>8 240 17 061</b>	<b>Boring bar holder Ø 1"</b>	
	Weight [kg]:	2.300
	Shank type:	BMT
	Machine adaption:	Centering key b 20
	Tool adaption:	Ø 1" (25,4mm)
	Coolant:	IC/Ext
	Center distance [mm]:	55
<b>8 240 17 065</b>	<b>Boring bar holder Ø 25 - slotted</b>	
	Weight [kg]:	3.670
	Notation:	180° reversible
	Shank type:	BMT
	Machine adaption:	Centering key b 20
	Tool adaption:	Ø 25
	Coolant:	EXT
	Please note:	Housing rigid
	Center distance [mm]:	75
<b>8 240 17 078</b>	<b>Boring bar holder Ø 1 1/4" - slotted</b>	
	Weight [kg]:	3.440
	Notation:	180° reversible
	Shank type:	BMT
	Machine adaption:	Centering key b 20
	Tool adaption:	Ø 1 1/4" (31,75mm)
	Coolant:	EXT
	Please note:	Housing rigid
	Center distance [mm]:	75

Part-#	Name	
<b>8 240 17 096</b>	<b>Tool holder C 5 IC</b>	
	Weight [kg]:	5.030
	Notation:	180° reversible
	Version:	right
	Shank type:	BMT
	Machine adaption:	Centering key b 20
	Tool adaption:	heimatec Capto(TM) C 5
	Coolant:	IC
	Please note:	Check applicability; note tool length!
	Center distance [mm]:	75
<b>8 240 17 106</b>	<b>Boring bar holder Ø 25</b>	
	Weight [kg]:	4.800
	Notation:	180° reversible
	Shank type:	BMT
	Machine adaption:	Centering key b 20
	Tool adaption:	Ø 25
	Coolant:	IC/Ext
	Please note:	Check applicability! housing rigid
	Center distance [mm]:	95
<b>8 240 17 114</b>	<b>Boring bar holder Ø 1"</b>	
	Weight [kg]:	4.760
	Notation:	180° reversible
	Shank type:	BMT
	Machine adaption:	Centering key b 20
	Tool adaption:	Ø 1" (25,4mm)
	Coolant:	IC/Ext
	Please note:	Check applicability! housing rigid
	Center distance [mm]:	95
<b>8 240 17 115</b>	<b>Boring bar holder Ø 1 1/4"</b>	
	Weight [kg]:	4.620
	Notation:	180° reversible
	Shank type:	BMT
	Machine adaption:	Centering key b 20
	Tool adaption:	Ø 1 1/4" (31,75mm)
	Coolant:	IC/Ext
	Please note:	Check applicability! housing rigid
	Center distance [mm]:	95
<b>8 240 17 116</b>	<b>Boring bar holder Ø 1 1/4"</b>	
	Weight [kg]:	2.440
	Notation:	180° reversible
	Shank type:	BMT
	Machine adaption:	Centering key b 20
	Tool adaption:	Ø 1 1/4" (31,75mm)
	Coolant:	IC/Ext
	Please note:	Housing rigid
	Center distance [mm]:	75

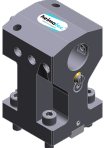
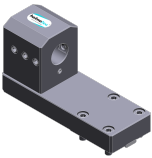

Part-#	Name	
8 240 18 010	<b>Boring bar holder Ø 32</b>	
		<p>Weight [kg]: 3.640            Notation: 180° reversible            Shank type: BMT            Machine adaption: Centering key b 20            Tool adaption: Ø 32            Coolant: IC/Ext            Pressure max [bar]: 140            Please note: Housing rigid            Center distance [mm]: 75</p>
8 240 18 011	<b>Boring bar holder Ø 32</b>	<p>Weight [kg]: 2.680            Shank type: BMT            Machine adaption: Centering key b 20            Tool adaption: Ø 32            Coolant: IC/Ext            Center distance [mm]: 55</p>
8 240 18 012	<b>Boring bar holder Ø 32 offset</b>	<p>Weight [kg]: 2.420            Notation: 180° reversible            Version: offset            Shank type: BMT            Machine adaption: Centering key b 20            Tool adaption: Ø 32            Coolant: IC/Ext            Please note: Housing rigid            Center distance [mm]: 75</p>
8 240 18 016	<b>Boring bar holder Ø 32</b>	<p>Weight [kg]: 4.370            Notation: 180° reversible            Shank type: BMT            Machine adaption: Centering key b 20            Tool adaption: Ø 32            Coolant: IC/Ext            Please note: Housing rigid            Center distance [mm]: 90</p>
8 240 18 021	<b>Insert drill holder 32 IC</b>	<p>Weight [kg]: 4.200            Notation: 180° reversible            Shank type: BMT            Tool adaption: Whistle-Notch (DIN 1835 E) 32            Coolant: IC            Center distance [mm]: 75</p>
8 240 18 033	<b>Boring bar holder Ø 1 1/4"</b>	<p>Weight [kg]: 3.630            Notation: 180° reversible            Shank type: BMT            Machine adaption: Centering key b 20            Tool adaption: Ø 1 1/4" (31,75mm)            Coolant: IC/Ext            Please note: Housing rigid            Center distance [mm]: 75</p>

Part-#	Name	
<b>8 240 18 037</b>	<b>Boring bar holder Ø 1 1/2"</b>	
	Weight [kg]:	4.540
	Notation:	180° reversible
	Shank type:	BMT
	Machine adaption:	Centering key b 20
	Tool adaption:	Ø 1 1/2" (38,1mm)
	Coolant:	IC/Ext
	Center distance [mm]:	75
<b>8 240 18 045</b>	<b>Boring bar holder Ø 32 offset</b>	
	Weight [kg]:	4.380
	Notation:	offset
	Shank type:	BMT
	Machine adaption:	Centering key b 20
	Tool adaption:	Ø 32
	Coolant:	IC/Ext
	Please note:	Front edge Ø32- adapter on turret center
	Center distance [mm]:	75
<b>8 240 18 085</b>	<b>Boring bar holder Ø 32</b>	
	Weight [kg]:	4.605
	Notation:	180° reversible
	Shank type:	BMT
	Machine adaption:	Centering key b 20
	Tool adaption:	Ø 32
	Coolant:	IC/Ext
	Please note:	Check applicability! housing rigid
	Center distance [mm]:	95
<b>8 240 18 098</b>	<b>Boring bar holder Ø 1 1/4"</b>	
	Notation:	180° reversible
	Shank type:	BMT
	Machine adaption:	Centering key b 20
	Tool adaption:	Ø 1 1/4" (31,75mm)
	Coolant:	IC/Ext
	Please note:	Check applicability!
	Center distance [mm]:	100
<b>8 240 18 102</b>	<b>Boring bar holder Ø 32 offset</b>	
	Weight [kg]:	6.780
	Notation:	180° reversible
	Version:	offset
	Shank type:	BMT
	Machine adaption:	Centering key b 20
	Tool adaption:	Ø 32
	Coolant:	IC
	Pressure max [bar]:	100
	Please note:	Check applicability! length
	Center distance [mm]:	80
<b>8 240 19 007</b>	<b>Boring bar holder Ø 40</b>	
	Weight [kg]:	4.260
	Notation:	offset; 180° reversible
	Shank type:	BMT
	Machine adaption:	Centering key b 20
	Tool adaption:	Ø 40
	Coolant:	IC/Ext

Part-#	Name	
	Center distance [mm]:	75
<b>8 240 19 009</b>	<b>Boring bar holder Ø 40</b>	
	Weight [kg]:	4.480
	Notation:	180° reversible
	Shank type:	BMT
	Machine adaption:	Centering key b 20
	Tool adaption:	Ø 40
	Coolant:	IC/Ext
	Center distance [mm]:	75
<b>8 240 19 012</b>	<b>Boring bar holder Ø 40</b>	
	Weight [kg]:	3.460
	Shank type:	BMT
	Machine adaption:	Centering key b 20
	Tool adaption:	Ø 40
	Coolant:	IC/Ext
	Please note:	Special version
	Center distance [mm]:	75
<b>8 240 19 025</b>	<b>Insert drill holder 40 IC</b>	
	Weight [kg]:	4.740
	Notation:	180° reversible
	Shank type:	BMT
	Tool adaption:	Whistle-Notch (DIN 1835 E) 40
	Coolant:	IC
	Center distance [mm]:	75
<b>8 240 19 105</b>	<b>Boring bar holder Ø 40</b>	
	Weight [kg]:	2.400
	Notation:	180° reversible
	Shank type:	BMT
	Machine adaption:	Centering key b 20
	Tool adaption:	Ø 40
	Coolant:	IC/Ext
	Center distance [mm]:	35
<b>8 240 19 139</b>	<b>Boring bar holder Ø 40</b>	
	Weight [kg]:	4.760
	Notation:	180° reversible
	Shank type:	BMT
	Machine adaption:	Centering key b 20
	Tool adaption:	Ø 40
	Coolant:	IC
	Please note:	Check applicability!
	Center distance [mm]:	100
<b>8 244 11 002</b>	<b>Facing holder sq. 20</b>	
	Weight [kg]:	2.340
	Notation:	180° reversible
	Shank type:	BMT
	Machine adaption:	Centering key b 20
	Tool adaption:	Sq. 20
	Coolant:	EXT



Part-#	Name	
<b>8 244 11 009</b>	<b>Facing holder sq. 20</b>	
	Weight [kg]:	4.090
	Notation:	180° reversible
	Version:	Special; extended version
	Shank type:	BMT
	Machine adaption:	Centering key b 20
	Tool adaption:	Sq. 20
	Coolant:	EXT
<b>8 244 12 005</b>	<b>Facing holder sq. 1"</b>	
	Weight [kg]:	3.570
	Shank type:	BMT
	Machine adaption:	Centering key b 20
	Tool adaption:	Sq. 1" (25,4mm)
	Coolant:	EXT
<b>8 244 12 027</b>	<b>Facing holder sq. 25 IC</b>	
	Weight [kg]:	3.640
	Shank type:	BMT
	Machine adaption:	Centering key b 20
	Tool adaption:	Sq. 25
	Coolant:	IC/Ext
	Pressure max [bar]:	100
<b>8 249 15 001</b>	<b>Double collet chuck holder ER 25</b>	
	Weight [kg]:	4.240
	Notation:	180° reversible
	Shank type:	BMT
	Machine adaption:	Centering key b 20
	Tool adaption:	ER 25
	Coolant:	IC/Ext
	Center distance [mm]:	75
<b>8 249 15 013</b>	<b>Double tool holder C 3 IC</b>	
	Weight [kg]:	4.210
	Notation:	180° reversible
	Employment for:	Main- and sub spindle
	Version:	offset; right
	Shank type:	BMT
	Machine adaption:	Centering key b 20
	Tool adaption:	heimatec Capto(TM) C 3
		heimatec Capto(TM) C 3
	Coolant:	IC
	Please note:	Check applicability; note tool length!
	Center distance [mm]:	82,5
<b>8 249 16 000</b>	<b>Double collet chuck holder ER 32</b>	
	Weight [kg]:	4.000
	Notation:	180° reversible
	Shank type:	BMT
	Machine adaption:	Centering key b 20
	Tool adaption:	ER 32
	Coolant:	IC/Ext
	Center distance [mm]:	75

Part-#	Name	
<b>8 250 16 005</b>	<b>Multiple tool holder C 4 IC</b>	
	Weight [kg]:	4.620
	Employment for:	Main- and sub spindle
	Version:	right
	Shank type:	BMT
	Machine adaption:	Centering key b 20
	Tool adaption:	heimatec Capto(TM) C 4
	Coolant:	IC
	Please note:	Check applicability; note tool length!
	Offset [mm]:	±55
<b>8 250 16 007</b>	<b>Double tool holder C 4 IC</b>	
	Weight [kg]:	4.630
	Notation:	180° reversible
	Employment for:	Main- and sub spindle
	Version:	left
	Shank type:	BMT
	Machine adaption:	Centering key b 20
	Tool adaption:	heimatec Capto(TM) C 4
	Coolant:	IC
	Please note:	Check applicability; note tool length!
	Offset [mm]:	±55
<b>8 251 12 006</b>	<b>Double turning holder sq. 25</b>	
	Weight [kg]:	4.910
	Notation:	180° reversible
	Employment for:	right cutting tools
	Shank type:	BMT
	Machine adaption:	Centering key b 20
	Tool adaption:	Sq. 25
	Coolant:	EXT
<b>8 251 13 007</b>	<b>Combi multiple holder 6x sq. 3/4" IC</b>	
	Weight [kg]:	5.600
	Employment for:	Main- and sub spindle
	Shank type:	BMT
	Machine adaption:	Centering key b 20
	Tool adaption:	Sq. 3/4" (19,05mm)
		Sq. 3/4" (19,05mm)
		Sq. 3/4" (19,05mm)
		Sq. 3/4" (19,05mm)
	Coolant:	IC/Ext
	Pressure max [bar]:	100
	Please note:	Key rail
<b>8 251 13 008</b>	<b>Combi multiple holder 3x sq. 3/4" IC</b>	
	Shank type:	BMT
	Machine adaption:	Centering key b 20
	Tool adaption:	Sq. 3/4" (19,05mm)
		Sq. 3/4" (19,05mm)
	Coolant:	IC/Ext
	Pressure max [bar]:	100
	Please note:	Key rail



Part-#	Name	
<b>8 251 14 027</b>	<b>Combi multiple holder 6x sq. 3/4"</b>	
	Weight [kg]:	5.900
	Shank type:	BMT
	Machine adaption:	Centering key b 20
	Tool adaption:	Sq. 3/4"
		Sq. 3/4"
		Sq. 3/4"
		Sq. 3/4"
	Coolant:	EXT
	Pressure max [bar]:	80
<b>8 251 14 078</b>	<b>Combi multiple holder 6x sq. 20 IC</b>	
	Weight [kg]:	5.620
	Employment for:	Main- and sub spindle
	Shank type:	BMT
	Machine adaption:	Centering key b 20
	Tool adaption:	Sq. 20
		Sq. 20
		Sq. 20
		Sq. 20
		Sq. 20
	Coolant:	IC/Ext
	Pressure max [bar]:	100
	Please note:	Key rail
<b>8 251 14 079</b>	<b>Combi multiple holder 3x sq. 20 IC</b>	
	Weight [kg]:	3.650
	Shank type:	BMT
	Machine adaption:	Centering key b 20
	Tool adaption:	Sq. 20
		Sq. 20
		Sq. 20
	Coolant:	IC/Ext
	Pressure max [bar]:	100
	Please note:	Key rail
<b>8 251 15 048</b>	<b>Combi double turning holder sq. 25 IC</b>	
	Notation:	180° reversible
	Employment for:	Main- and sub spindle
	Shank type:	BMT
	Machine adaption:	Centering key b 20
	Tool adaption:	Sq. 25
		Sq. 25
		Sq. 25
		Sq. 25
		Sq. 25
	Coolant:	IC/Ext
	Pressure max [bar]:	100
	Please note:	Key rail
<b>8 251 16 013</b>	<b>Multiple tool holder C 4 IC</b>	
	Weight [kg]:	6.400
	Employment for:	Main- and sub spindle
	Version:	right
	Shank type:	BMT
	Machine adaption:	Centering key b 20
	Tool adaption:	heimatec Capto(TM) C 4
		heimatec Capto(TM) C 4
	Coolant:	IC
	Please note:	Check applicability; note tool length!

Nakamura  
AS-200 - 12 Stationen

Part-#	Name	
	Offset [mm]:	±64
<b>8 253 16 010</b>	<b>Multiple tool holder C 4 IC</b>	
	Weight [kg]:	6.240
	Version:	right
	Shank type:	BMT
	Machine adaption:	Centering key b 20
	Tool adaption:	heimatec Capto(TM) C 4 heimatec Capto(TM) C 4 - 15°
	Coolant:	IC/Ext
	Please note:	Check applicability; note tool length!
	Center distance [mm]:	75
<b>8 253 16 011</b>	<b>Multiple tool holder C 4 IC</b>	
	Weight [kg]:	5.480
	Employment for:	Main spindle
	Version:	offset; right
	Shank type:	BMT
	Machine adaption:	Centering key b 20
	Tool adaption:	heimatec Capto(TM) C 4 heimatec Capto(TM) C 4 - 15°
	Coolant:	IC/Ext
	Please note:	Check applicability; note tool length!
	Center distance [mm]:	75
<b>8 253 16 014</b>	<b>Multiple tool holder C 4 IC</b>	
	Version:	offset; right
	Shank type:	BMT
	Machine adaption:	Centering key b 20
	Tool adaption:	heimatec Capto(TM) C 4 heimatec Capto(TM) C 4 - 15°
	Coolant:	IC
	Please note:	Check applicability; note tool length!
	Center distance [mm]:	75
<b>8 253 16 018</b>	<b>Multiple tool holder C 4 IC</b>	
	Version:	right
	Shank type:	BMT
	Machine adaption:	Centering key b 20
	Tool adaption:	heimatec Capto(TM) C 4 heimatec Capto(TM) C 4 - 15°
	Coolant:	IC
	Please note:	Check applicability; note tool length!
	Center distance [mm]:	75
<b>8 253 16 025</b>	<b>Multiple tool holder C 4 IC</b>	
	Weight [kg]:	6.320
	Version:	right
	Shank type:	BMT
	Machine adaption:	Centering key b 20
	Tool adaption:	heimatec Capto(TM) C 4 heimatec Capto(TM) C 4 - 15°
	Coolant:	IC
	Please note:	Check applicability; note tool length!
	Center distance [mm]:	75

Part-#	Name	
8 253 16 026	<b>Multiple tool holder C 4 IC</b>	
	Weight [kg]:	0.100
	Version:	offset; right
	Shank type:	BMT
	Machine adaption:	Centering key b 20
	Tool adaption:	heimatec Capto(TM) C 4 heimatec Capto(TM) C 4 - 15°
	Coolant:	IC
	Please note:	Check applicability; note tool length!
	Center distance [mm]:	75
8 253 17 013	<b>Multiple boring bar holder Ø 25</b>	
	Weight [kg]:	2.520
	Notation:	180° reversible
	Shank type:	BMT
	Machine adaption:	Centering key b 20
	Tool adaption:	Ø 25
	Coolant:	IC/Ext
	Center distance [mm]:	39/75
8 253 17 064	<b>Multiple boring bar holder 2x Ø 25</b>	
	Weight [kg]:	5.140
	Employment for:	Main- and sub spindle
	Shank type:	BMT
	Machine adaption:	Centering key b 20
	Tool adaption:	Ø 25 Ø 25 - 15°
	Coolant:	IC/Ext
	Center distance [mm]:	75
8 253 17 066	<b>Double boring bar holder Ø 1"</b>	
	Weight [kg]:	2.500
	Shank type:	BMT
	Machine adaption:	Centering key b 20
	Tool adaption:	Ø 1" (25,4mm)
	Coolant:	IC/Ext
	Center distance [mm]:	39/75
8 253 17 067	<b>Multiple boring bar holder 2x Ø 1"</b>	
	Weight [kg]:	5.120
	Employment for:	Main- and sub spindle
	Shank type:	BMT
	Machine adaption:	Centering key b 20
	Tool adaption:	Ø 1" (25,4mm) Ø 1" (25,4mm) - 15°
	Coolant:	IC/Ext
	Center distance [mm]:	75
8 253 17 086	<b>Multiple boring bar holder 3x Ø 1"</b>	
	Weight [kg]:	6.470
	Employment for:	Main- and sub spindle
	Shank type:	BMT
	Machine adaption:	Centering key b 20
	Tool adaption:	Ø 1" Ø 1"
	Coolant:	IC/Ext
	Center distance [mm]:	55/95

Nakamura  
AS-200 - 12 Stationen

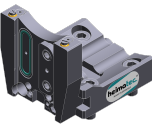
Part-#	Name	
<b>8 259 12 010</b>	<b>Multiple turning holder 2x sq. 20</b>	
	Weight [kg]:	2.890
	Notation:	180° reversible
	Version:	Y-axes offset
	Shank type:	BMT
	Machine adaption:	Centering key b 20
	Tool adaption:	Sq. 20
		Sq. 20
	Coolant:	EXT
<b>8 262 19 001</b>	<b>Stock stop Ø 60 offset</b>	
	Weight [kg]:	3.440
	Notation:	rotating
	Shank type:	BMT
	Machine adaption:	Centering key b 20
	Coolant:	no
	Please note:	Lenght adjustable
	Center distance [mm]:	75
<b>8 263 19 002</b>	<b>Tool holder with rotating centering point</b>	
	Weight [kg]:	4.280
	Notation:	180° reversible
	Shank type:	BMT
	Machine adaption:	Centering key b 20
	Rotation max [1/min]:	6000
	Coolant:	EXT
	Please note:	Taper roller bearings
	Center distance [mm]:	75
<b>8 320 12 010</b>	<b>Cut-off holder, height adjustable SH 26 IC</b>	
	Weight [kg]:	1.680
	Notation:	180° reversible
	Shank type:	BMT
	Machine adaption:	Centering key b 20
	Tool adaption:	Clampshaft SH 26
	Coolant:	IC/Ext
	Pressure max [bar]:	70
<b>8 320 12 020</b>	<b>Cut-off holder, height adjustable SH 26 IC</b>	
	Notation:	180° reversible
	Shank type:	BMT
	Machine adaption:	Centering key b 20
	Tool adaption:	Clampshaft SH 26
	Coolant:	IC/Ext
	Pressure max [bar]:	70
	Please note:	with offset cut-off tool holder
<b>8 320 13 002</b>	<b>Cut-off holder, height adjustable SH 32 IC</b>	
	Weight [kg]:	1.570
	Notation:	180° reversible
	Shank type:	BMT
	Machine adaption:	Centering key b 20
	Tool adaption:	Clampshaft SH 32
	Coolant:	IC/Ext
	Pressure max [bar]:	70

Part-#	Name
--------	------

**8 320 13 010**

**Cut-off holder, height adjustable SH 32 IC**

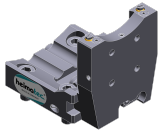

Weight [kg]: 1.730  
 Notation: 180° reversible  
 Shank type: BMT  
 Machine adaption: Centering key b 20  
 Tool adaption: Clampshaft SH 32  
 Coolant: IC/Ext  
 Pressure max [bar]: 70  
 Please note: Clampshaft internal

**8 320 13 015**

**Cut-off holder, height adjustable SH 32 IC**



Weight [kg]: 1.830  
 Notation: 180° reversible  
 Shank type: BMT  
 Machine adaption: Centering key b 20  
 Tool adaption: Clampshaft SH 32  
 Coolant: IC/Ext  
 Pressure max [bar]: 70  
 Please note: with offset cut-off tool holder

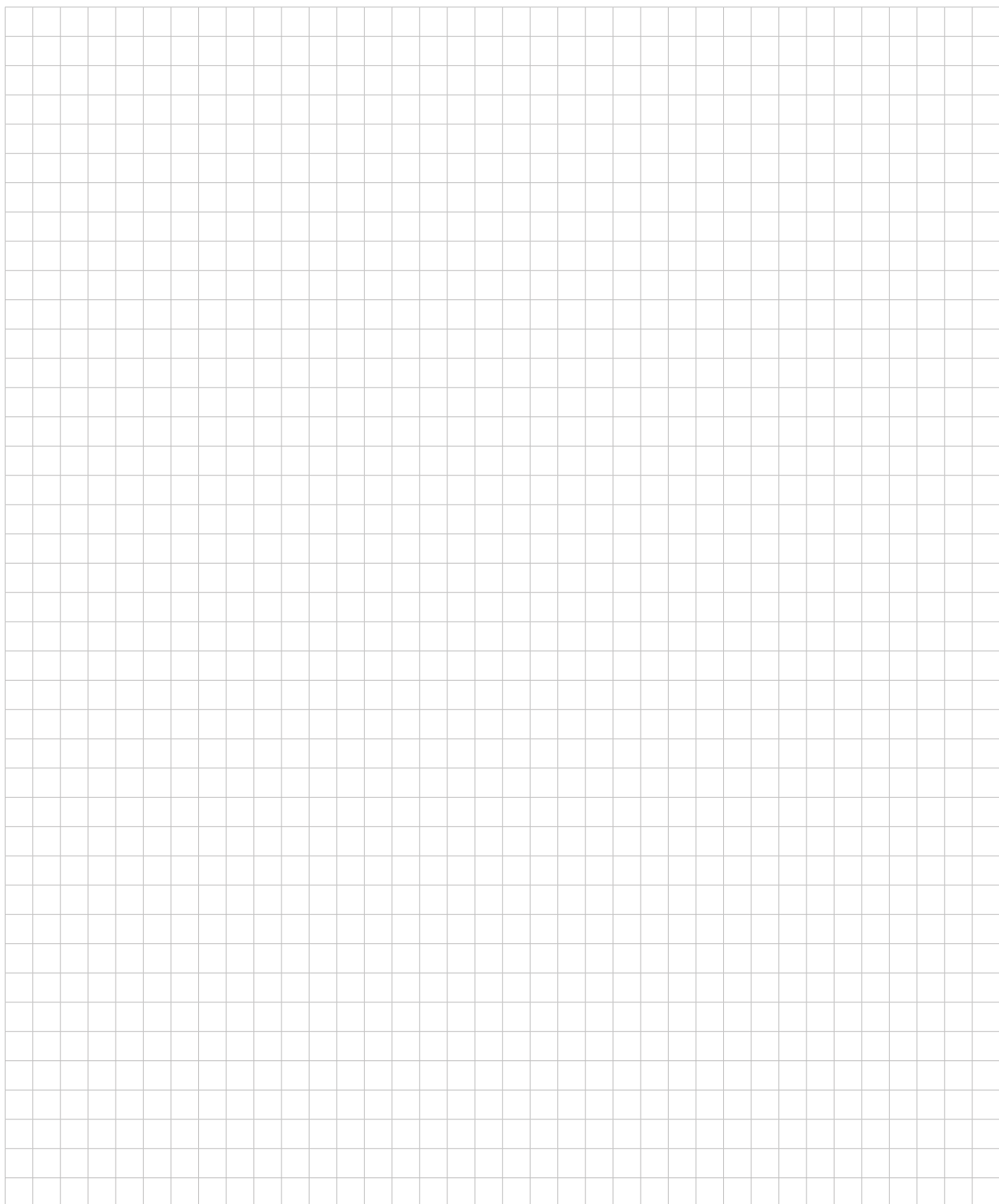

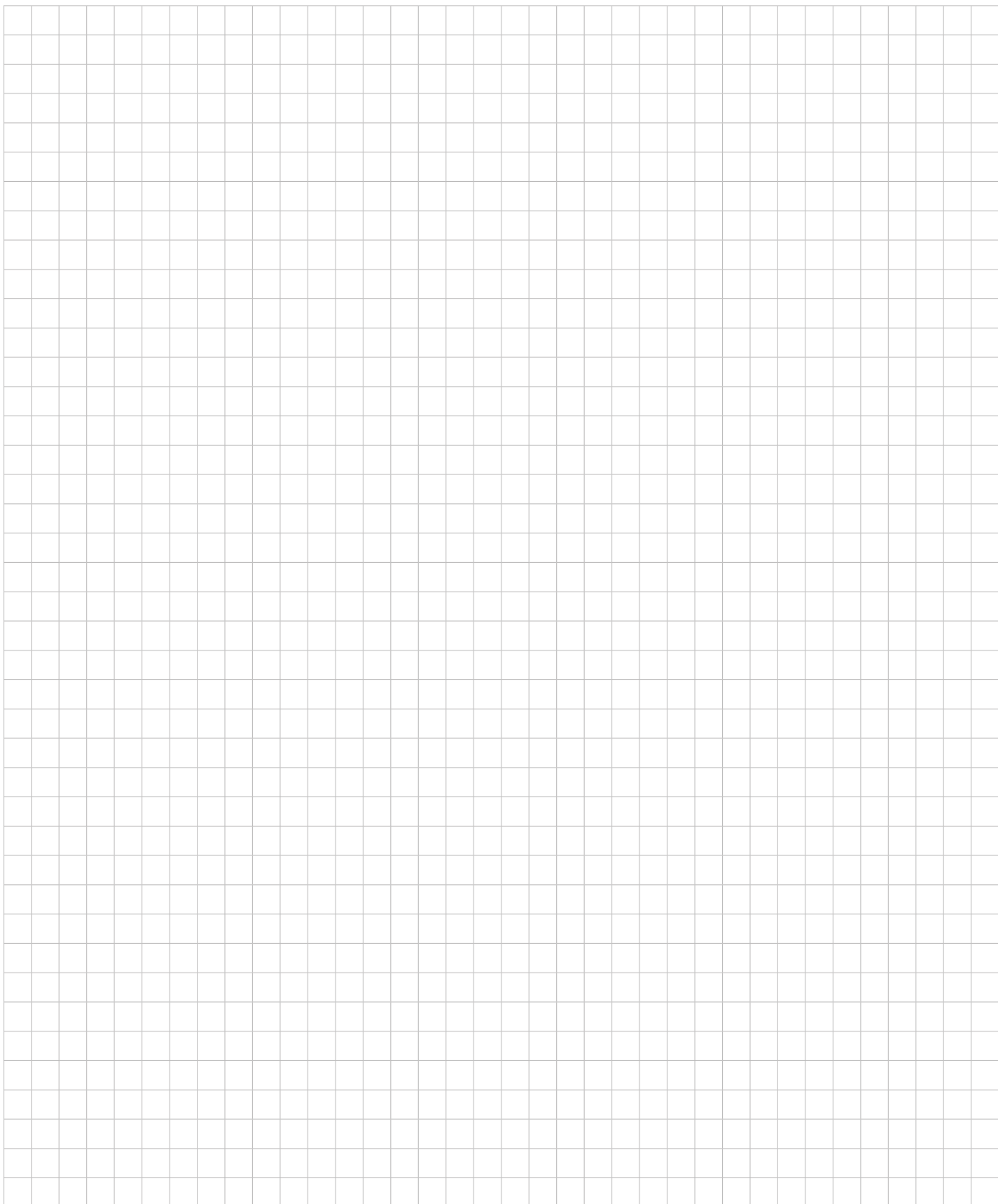

## heimatec.u-tec®

heimatec.com

Products / Tool change systems /  
u-tec® Tool-changing system



versions see catalog

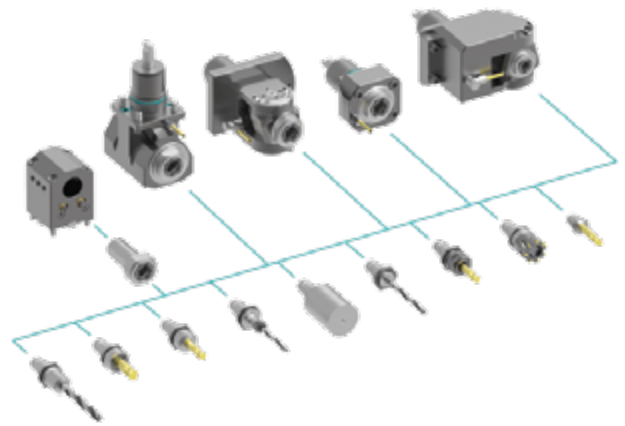

## heimatec.easy-quick

heimatec.com

Products / Tool change systems /  
easy-quick HT quick-changing system



versions see catalog

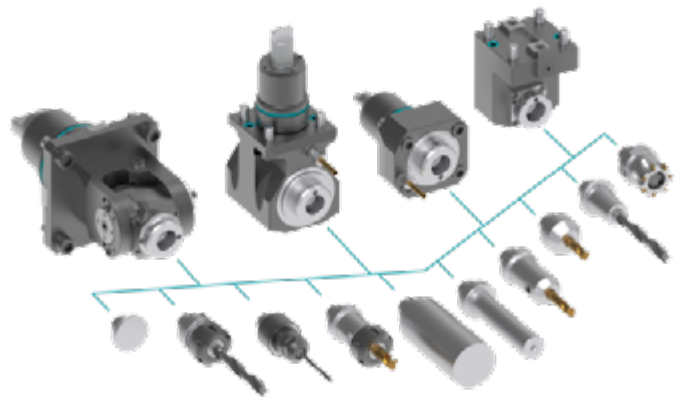

## heimatec.Capto™

heimatec.com

Products / Tool change systems /  
heimatec.Capto™ quick-changing system



versions see catalog

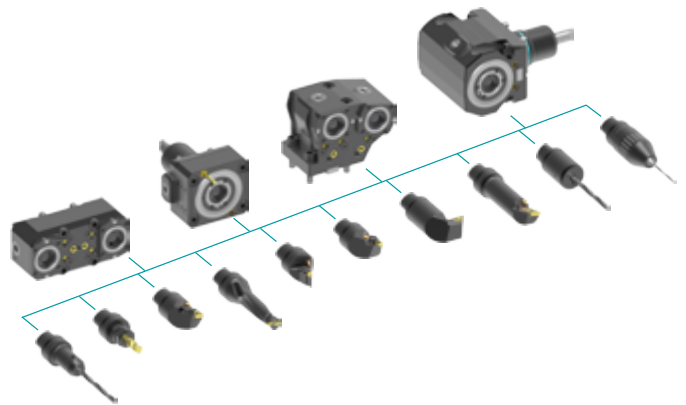

## heimatec.accessories

heimatec.com

Products / Accessories



versions see catalog





● heimatec overseas branches

○ global representations of heimatec

**heimatec**<sup>®</sup>

**heimatec GmbH**  
Präzisionswerkzeuge  
Carl-Benz-Str. 4  
77871 Renchen  
Germany

T +49 7843 9466 0  
[www.heimatec.com](http://www.heimatec.com)  
[info@heimatec.com](mailto:info@heimatec.com)

Please find the contact details of our worldwide trading partners on our website:  
<https://heimatec.com/business-partners>