

Nakamura
AS-200L - 12
Stationen



High-tech from heimatec - heimatec - Tools and systems for productive turning and milling

heimatec belongs to the international technology and quality leaders for precision tools and specializes in the development and production of high-precision static and live tools for all CNC lathes, CNC turn-/mill machines and CNC machining centers.

The range of products* spans from static BMT and VDI tool holders, live tools up to highly complex customer-specific individual solutions. heimatec, headquartered in Renchen, has a own subsidiary in Asia and India and numerous representatives as well as trading partners all over the world.

*OUR PRODCUTS

Static tool holders

Live tool units

Precision tools

Tools for turning and machining centres

Tools for swiss type lathes

Tool changing and uick-change systems

Tool systems for gear production

Digital tool management

This catalogue, including all its parts, is protected by copyright. Any use outside the restricted limitations of the Copyright Act without the consent of heimatec is inadmissible and liable to prosecution. This applies in particular to duplication, translation, microfilming and storage and processing in electronic systems.

heimatec GmbH reserves the right to make technical changes at any time without giving prior notice. This applies in particular to adjustments at any time to meet new or changed international standards, or in case of further developments of our products or manufacturing processes.

The current version of our General Terms and Conditions can be found on our website.

Part-#

Name

8 010 55 033**Axial milling and drill holder ER 25 AX UT**

Weight [kg]: 2.830
 Tool drive: Flat (~DIN 1809)
 Shank size [mm]: 55.00
 Shank type: BMT
 Tool adaption: ER 25 A - u-tec
 Gear ratio [i]: 1:1
 Torque max [Nm]: 50
 Rotation max [1/min]: 6000
 Rotating direction: same
 Coolant: EXT
 Please note: Combi bearing

8 010 55 035**Axial milling and drill holder ER 25 AX UT IC**

Weight [kg]: 2.860
 Tool drive: Flat (~DIN 1809)
 Shank size [mm]: 55.00
 Shank type: BMT
 Tool adaption: ER 25 A - u-tec
 Gear ratio [i]: 1:1
 Torque max [Nm]: 50
 Rotation max [1/min]: 6000
 Rotating direction: same
 Coolant: IC/Ext
 Pressure max [bar]: 100
 Please note: Combi bearing; high pressure version; dryrun possible

8 010 55 049**Axial drilling and milling head Weldon 16**

Weight [kg]: 3.140
 Tool drive: Flat (~DIN 1809)
 Shank size [mm]: 55.00
 Shank type: BMT
 Tool adaption: Weldon (DIN 1835 b) 16
 Gear ratio [i]: 1:1
 Torque max [Nm]: 50
 Rotation max [1/min]: 6000
 Rotating direction: same
 Coolant: EXT
 Please note: Combi bearing

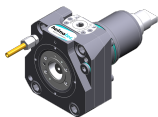
8 010 55 068**Axial drilling and milling head C 3**

Notation: 180° reversible
 Tool drive: Flat (~DIN 1809)
 Shank type: BMT
 Tool adaption: heimatec Capto(TM) C 3
 Gear ratio [i]: 1:1
 Torque max [Nm]: 32
 Rotation max [1/min]: 8000
 Rotating direction: same
 Coolant: EXT

Part-#

Name

8 010 55 069**Axial drilling and milling head C 3 IC**

Notation: 180° reversible
 Tool drive: Flat (~DIN 1809)
 Shank type: BMT
 Tool adaption: heimatec Capto(TM) C 3
 Gear ratio [i]: 1:1
 Torque max [Nm]: 32
 Rotation max [1/min]: 8000
 Rotating direction: same
 Coolant: IC/Ext
 Pressure max [bar]: 100

8 010 55 078**Axial drilling and milling head Weldon 3/4" IC**

Weight [kg]: 3.200
 Tool drive: Flat (~DIN 1809)
 Shank size [mm]: 55.00
 Shank type: BMT
 Tool adaption: Weldon (DIN 1835 b) 3/4" (19,05mm)
 Gear ratio [i]: 1:1
 Torque max [Nm]: 50
 Rotation max [1/min]: 6000
 Rotating direction: same
 Coolant: IC/Ext
 Pressure max [bar]: 25
 Please note: Combi bearing

8 010 55 081**Axial drilling and milling head Weldon 3/4"**

Weight [kg]: 3.200
 Tool drive: Flat (~DIN 1809)
 Shank size [mm]: 55.00
 Shank type: BMT
 Tool adaption: Weldon (DIN 1835 b) 3/4" (19,05mm)
 Gear ratio [i]: 1:1
 Torque max [Nm]: 50
 Rotation max [1/min]: 6000
 Rotating direction: same
 Coolant: EXT
 Please note: Combi bearing

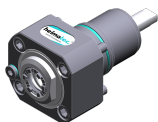
8 010 55 092**Axial drilling and milling head ER 25 AX UT IC**

Weight [kg]: 2.870
 Tool drive: Flat (~DIN 1809)
 Shank size [mm]: 55.00
 Shank type: BMT
 Tool adaption: ER 25 A - u-tec
 Gear ratio [i]: 1:1
 Torque max [Nm]: 50
 Rotation max [1/min]: 6000
 Rotating direction: same
 Coolant: IC air
 Pressure max [bar]: 10
 Please note: Combi bearing

Part-#

Name

8 010 55 109**Axial drilling and milling head ER 25 AX UT**

Weight [kg]: 2.600
 Tool drive: Flat (~DIN 1809)
 Shank size [mm]: 55.00
 Shank type: BMT
 Tool adaption: ER 25 A - u-tec
 Gear ratio [i]: 1:1
 Torque max [Nm]: 50
 Rotation max [1/min]: 12000
 Rotating direction: same
 Coolant: EXT

8 010 55 111**Axial drilling and milling head ER 25 AX UT IC**

Weight [kg]: 3.000
 Tool drive: Flat (~DIN 1809)
 Shank size [mm]: 55.00
 Shank type: BMT
 Tool adaption: ER 25 A - u-tec
 Gear ratio [i]: 1:1
 Torque max [Nm]: 50
 Rotation max [1/min]: 15000
 Rotating direction: same
 Coolant: IC/Ext
 Pressure max [bar]: 100
 Please note: Dryrun possible

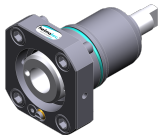
8 010 56 031**Axial drilling and milling head HT 4 IC**

Weight [kg]: 1.760
 Tool drive: Flat (~DIN 1809)
 Shank size [mm]: 55.00
 Shank type: BMT
 Tool adaption: HT 4
 Gear ratio [i]: 1:1
 Torque max [Nm]: 50
 Rotation max [1/min]: 6000
 Rotating direction: same
 Coolant: IC/Ext
 Pressure max [bar]: 25
 Please note: short version

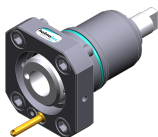
8 010 56 032**Axial drilling and milling head HT 4**

Weight [kg]: 1.740
 Tool drive: Flat (~DIN 1809)
 Shank size [mm]: 55.00
 Shank type: BMT
 Tool adaption: HT 4
 Gear ratio [i]: 1:1
 Torque max [Nm]: 50
 Rotation max [1/min]: 6000
 Rotating direction: same
 Coolant: EXT
 Please note: short version

Part-#

Name

8 010 56 059**Axial drilling and milling head HT 4**

Weight [kg]: 2.880
 Tool drive: Flat (~DIN 1809)
 Shank size [mm]: 55.00
 Shank type: BMT
 Tool adaption: HT 4
 Gear ratio [i]: 1:1
 Torque max [Nm]: 50
 Rotation max [1/min]: 6000
 Rotating direction: same
 Coolant: EXT
 Please note: Combi bearing

8 010 56 063**Axial milling and drill holder ER 32 AX UT**

Weight [kg]: 3.000
 Tool drive: Flat (~DIN 1809)
 Shank size [mm]: 55.00
 Shank type: BMT
 Tool adaption: ER 32 A - u-tec
 Gear ratio [i]: 1:1
 Torque max [Nm]: 50
 Rotation max [1/min]: 6000
 Rotating direction: same
 Coolant: EXT
 Please note: Combi bearing

8 010 56 064**Axial milling and drill holder ER 32 AX UT IC**

Weight [kg]: 3.020
 Tool drive: Flat (~DIN 1809)
 Shank size [mm]: 55.00
 Tool adaption: ER 32 A - u-tec
 Gear ratio [i]: 1:1
 Torque max [Nm]: 50
 Rotation max [1/min]: 6000
 Rotating direction: same
 Coolant: IC/Ext
 Pressure max [bar]: 25
 Please note: Combi bearing

8 010 56 065**Axial milling and drill holder ER 32 AX UT IC**

Weight [kg]: 3.020
 Tool drive: Flat (~DIN 1809)
 Shank size [mm]: 55.00
 Shank type: BMT
 Tool adaption: ER 32 A - u-tec
 Gear ratio [i]: 1:1
 Torque max [Nm]: 50
 Rotation max [1/min]: 6000
 Rotating direction: same
 Coolant: IC/Ext
 Pressure max [bar]: 100
 Please note: Combi bearing; dryrun possible

Part-#

Name

8 010 56 066**Axial drilling and milling head HT 4 IC**

Weight [kg]: 2.930
 Tool drive: Flat (~DIN 1809)
 Shank size [mm]: 55.00
 Shank type: BMT
 Tool adaption: HT 4
 Gear ratio [i]: 1:1
 Torque max [Nm]: 50
 Rotation max [1/min]: 6000
 Rotating direction: same
 Coolant: IC/Ext
 Pressure max [bar]: 25
 Please note: Combi bearing

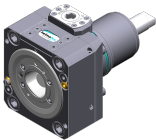
8 010 56 110**Axial drilling and milling head C 4**



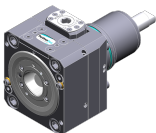

Weight [kg]: 4.750
 Notation: 180° reversible
 Tool drive: Flat (~DIN 1809)
 Shank size [mm]: 55.00
 Shank type: BMT
 Tool adaption: heimatec Capto(TM) C 4
 Gear ratio [i]: 1:1
 Torque max [Nm]: 50
 Rotation max [1/min]: 6000
 Rotating direction: same
 Coolant: EXT
 Please note: Check applicability; tool length check !

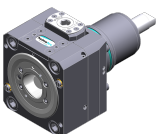
8 010 56 111**Axial drilling and milling head C 4 IC**

Weight [kg]: 5.800
 Notation: 180° reversible
 Tool drive: Flat (~DIN 1809)
 Shank size [mm]: 55.00
 Shank type: BMT
 Machine adaption: Centering key b 20
 Tool adaption: heimatec Capto(TM) C 4
 Gear ratio [i]: 1:1
 Torque max [Nm]: 50
 Rotation max [1/min]: 6000
 Rotating direction: same
 Coolant: IC/Ext
 Pressure max [bar]: 100
 Please note: Check applicability; tool length check !

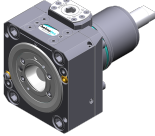
8 010 56 120**Axial drilling and milling head C 4 IC**

Notation: 180° reversible
 Tool drive: Flat (~DIN 1809)
 Shank size [mm]: 55.00
 Shank type: BMT
 Machine adaption: Centering key b 20
 Tool adaption: heimatec Capto(TM) C 4
 Gear ratio [i]: 1:1
 Torque max [Nm]: 50
 Rotation max [1/min]: 6000
 Rotating direction: same
 Coolant: IC/Ext

Part-#	Name	
	Pressure max [bar]:	25
	Please note:	Check applicability; tool length check !
8 010 56 138	Axial drilling and milling head C 4	
	Weight [kg]:	4.730
	Notation:	180° reversible
	Tool drive:	Flat (~DIN 1809)
	Shank size [mm]:	55.00
	Shank type:	BMT
	Tool adaption:	heimatec Capto(TM) C 4
	Gear ratio [i]:	1:1
	Torque max [Nm]:	50
	Rotation max [1/min]:	12000
	Rotating direction:	same
	Coolant:	EXT
	Please note:	Check applicability; tool length check !
8 010 56 140	Axial drilling and milling head ER 32 AX UT IC	
	Weight [kg]:	3.000
	Tool drive:	Flat (~DIN 1809)
	Shank size [mm]:	55.00
	Shank type:	BMT
	Tool adaption:	ER 32 A - u-tec
	Gear ratio [i]:	1:1
	Torque max [Nm]:	50
	Rotation max [1/min]:	6000
	Rotating direction:	same
	Coolant:	IC/Ext
	Pressure max [bar]:	100
8 010 56 144	Axial drilling and milling head HT 4 IC	
	Tool drive:	Flat (~DIN 1809)
	Shank size [mm]:	55.00
	Shank type:	BMT
	Tool adaption:	HT 4
	Gear ratio [i]:	1:1
	Torque max [Nm]:	50
	Rotation max [1/min]:	6000
	Rotating direction:	same
	Coolant:	IC/Ext
	Pressure max [bar]:	100
8 010 56 151	Axial drilling and milling head ER 32 AX UT	
	Weight [kg]:	2.770
	Tool drive:	Flat (~DIN 1809)
	Shank size [mm]:	55.00
	Shank type:	BMT
	Tool adaption:	ER 32 A - u-tec
	Gear ratio [i]:	1:1
	Torque max [Nm]:	50
	Rotation max [1/min]:	12000
	Rotating direction:	same
	Coolant:	EXT

Part-#

Name

8 010 56 153**Axial drilling and milling head ER 32 AX UT IC**

Weight [kg]: 3.180
 Tool drive: Flat (~DIN 1809)
 Shank size [mm]: 55.00
 Shank type: BMT
 Tool adaption: ER 32 A - u-tec
 Gear ratio [i]: 1:1
 Torque max [Nm]: 50
 Rotation max [1/min]: 15000
 Rotating direction: same
 Coolant: IC/Ext
 Pressure max [bar]: 100

8 011 54 006**Axial milling head universal arbor 3/4"**

Weight [kg]: 2.910
 Tool drive: Flat (~DIN 1809)
 Shank size [mm]: 55.00
 Shank type: BMT
 Tool adaption: Universal arbor 3/4" (19,05mm)
 Gear ratio [i]: 1:1
 Torque max [Nm]: 50
 Rotation max [1/min]: 6000
 Rotating direction: same
 Coolant: EXT
 Please note: Combi bearing

8 011 54 015**Axial milling head arbor 5/8"**

Weight [kg]: 2.880
 Tool drive: Flat (~DIN 1809)
 Shank size [mm]: 55.00
 Shank type: BMT
 Tool adaption: Arbor 5/8" (15,875mm)
 Gear ratio [i]: 1:1
 Torque max [Nm]: 50
 Rotation max [1/min]: 6000
 Rotating direction: same
 Coolant: EXT
 Please note: Combi bearing

8 011 55 014**Axial milling head universal arbor 22 IC**

Weight [kg]: 3.080
 Tool drive: Flat (~DIN 1809)
 Shank size [mm]: 55.00
 Shank type: BMT
 Tool adaption: Universal arbor 22
 Gear ratio [i]: 1:1
 Torque max [Nm]: 50
 Rotation max [1/min]: 6000
 Rotating direction: same
 Coolant: IC/Ext
 Pressure max [bar]: 100
 Please note: Combi bearing, Trockenauf possible

Part-#	Name	
8 011 55 015	Axial milling head universal arbor 22	
	Weight [kg]:	3.000
	Tool drive:	Flat (~DIN 1809)
	Shank size [mm]:	55.00
	Shank type:	BMT
	Tool adaption:	Universal arbor 22
	Gear ratio [i]:	1:1
	Torque max [Nm]:	50
	Rotation max [1/min]:	6000
	Rotating direction:	same
	Coolant:	EXT
	Please note:	Combi bearing
8 013 53 000	Axial drilling and milling head ER 11	
	Weight [kg]:	2.300
	Tool drive:	Flat (~DIN 1809)
	Shank size [mm]:	55.00
	Shank type:	BMT
	Tool adaption:	ER 11
	Gear ratio [i]:	1:4
	Torque max [Nm]:	2,5
	Rotation max [1/min]:	48000
	Rotating direction:	same
	Coolant:	EXT
8 013 54 005	Axial drilling and milling head ER 16 AX UT	
	Weight [kg]:	2.200
	Tool drive:	Flat (~DIN 1809)
	Shank size [mm]:	55.00
	Shank type:	BMT
	Tool adaption:	ER 16 A - u-tec
	Gear ratio [i]:	1:4
	Torque max [Nm]:	5
	Rotation max [1/min]:	24000
	Rotating direction:	same
	Coolant:	EXT
8 013 54 007	Axial drilling and milling head ER 16 AX UT IC	
	Tool drive:	Flat (~DIN 1809)
	Shank size [mm]:	55.00
	Shank type:	BMT
	Tool adaption:	ER 16 A - u-tec
	Gear ratio [i]:	1:4
	Torque max [Nm]:	5
	Rotation max [1/min]:	24000
	Rotating direction:	same
	Coolant:	IC/Ext
	Pressure max [bar]:	80
8 019 51 002	Axial drilling and milling head CHC	
	Weight [kg]:	6.880
	Notation:	IC-300
	Version:	no Splash-protection
	Tool drive:	Flat (~DIN 1809)
	Shank size [mm]:	55.00
	Shank type:	BMT

Part-#	Name
--------	------

Tool adaption: CHC
 Gear ratio [i]: 1:1,5
 Rotation max [1/min]: 18000
 Rotating direction: same
 Coolant: no
 Center distance [mm]: 77

8 019 54 014 Axial drilling and milling head ER 20 AX UT IC



Weight [kg]: 6.240
 Notation: offset; 180° reversible
 Tool drive: Flat (~DIN 1809)
 Shank size [mm]: 55.00
 Shank type: BMT
 Tool adaption: ER 20 A - u-tec
 Gear ratio [i]: 1:2
 Torque max [Nm]: 25
 Rotation max [1/min]: 12000
 Rotating direction: opposite
 Coolant: IC/Ext
 Pressure max [bar]: 140
 Please note: stronger bearing
 Offset [mm]: 42

8 019 54 055 Axial drilling and milling head ER 16 M IC

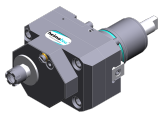





Weight [kg]: 6.200
 Notation: offset; 180° reversible
 Tool drive: Flat (~DIN 1809)
 Shank size [mm]: 55.00
 Shank type: BMT
 Tool adaption: ER 16 M
 Gear ratio [i]: 1:2
 Torque max [Nm]: 25
 Rotation max [1/min]: 12000
 Rotating direction: opposite
 Coolant: IC/Ext
 Pressure max [bar]: 140
 Please note: stronger bearing
 Offset [mm]: 42



8 019 55 018 Axial drilling and milling head ER 25 AX UT

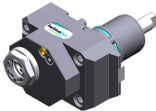

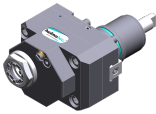

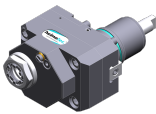

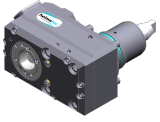
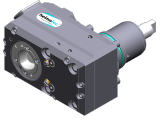
Weight [kg]: 5.230
 Notation: offset; 180° reversible
 Tool drive: Flat (~DIN 1809)
 Shank size [mm]: 55.00
 Shank type: BMT
 Tool adaption: ER 25 A - u-tec
 Gear ratio [i]: 1:1
 Torque max [Nm]: 40
 Rotation max [1/min]: 6000
 Rotating direction: opposite
 Coolant: EXT
 Please note: stronger bearing
 Offset [mm]: 42

Part-#	Name	
8 019 55 023	Axial drilling and milling head ER 25 AX UT IC	
	Weight [kg]:	6.260
	Notation:	offset; 180° reversible
	Tool drive:	Flat (~DIN 1809)
	Shank size [mm]:	55.00
	Shank type:	BMT
	Tool adaption:	ER 25 A - u-tec
	Gear ratio [i]:	1:1
	Torque max [Nm]:	40
	Rotation max [1/min]:	6000
	Rotating direction:	opposite
	Coolant:	IC/Ext
	Pressure max [bar]:	140
	Please note:	stronger bearing
	Offset [mm]:	42
8 019 55 024	Axial drilling and milling head ER 25 AX UT	
	Weight [kg]:	5.230
	Notation:	offset; 180° reversible
	Tool drive:	Flat (~DIN 1809)
	Shank size [mm]:	55.00
	Shank type:	BMT
	Tool adaption:	ER 25 A - u-tec
	Gear ratio [i]:	1:2
	Torque max [Nm]:	25
	Rotation max [1/min]:	12000
	Rotating direction:	opposite
	Coolant:	EXT
	Please note:	stronger bearing
	Offset [mm]:	42
8 019 55 025	Axial drilling and milling head ER 25 AX UT IC	
	Weight [kg]:	6.330
	Notation:	offset; 180° reversible
	Tool drive:	Flat (~DIN 1809)
	Shank size [mm]:	55.00
	Shank type:	BMT
	Tool adaption:	ER 25 A - u-tec
	Gear ratio [i]:	1:2
	Torque max [Nm]:	25
	Rotation max [1/min]:	12000
	Rotating direction:	opposite
	Coolant:	IC/Ext
	Pressure max [bar]:	140
	Please note:	stronger bearing
	Offset [mm]:	42
8 019 55 026	Axial drilling and milling head ER 25 AX UT	
	Weight [kg]:	5.300
	Notation:	offset; 180° reversible
	Tool drive:	Flat (~DIN 1809)
	Shank size [mm]:	55.00
	Shank type:	BMT
	Tool adaption:	ER 25 A - u-tec
	Gear ratio [i]:	1:3
	Torque max [Nm]:	16

Part-#	Name	
	Rotation max [1/min]:	18000
	Rotating direction:	opposite
	Coolant:	EXT
	Please note:	stronger bearing
	Offset [mm]:	42
8 019 55 027	Axial drilling and milling head ER 25 AX UT IC	
	Weight [kg]:	6.350
	Notation:	offset; 180° reversible
	Tool drive:	Flat (~DIN 1809)
	Shank size [mm]:	55.00
	Shank type:	BMT
	Tool adaption:	ER 25 A - u-tec
	Gear ratio [i]:	1:3
	Torque max [Nm]:	16
	Rotation max [1/min]:	18000
	Rotating direction:	opposite
	Coolant:	IC/Ext
	Pressure max [bar]:	140
	Please note:	stronger bearing
	Offset [mm]:	42
8 019 55 028	Axial drilling and milling head ER 25 AX UT	
	Weight [kg]:	5.240
	Notation:	offset; 180° reversible
	Tool drive:	Flat (~DIN 1809)
	Shank size [mm]:	55.00
	Shank type:	BMT
	Tool adaption:	ER 25 A - u-tec
	Gear ratio [i]:	2:1
	Torque max [Nm]:	50
	Rotation max [1/min]:	3000
	Rotating direction:	opposite
	Coolant:	EXT
	Please note:	stronger bearing
	Offset [mm]:	42
8 019 55 029	Axial drilling and milling head ER 25 AX UT IC	
	Weight [kg]:	6.220
	Notation:	offset; 180° reversible
	Tool drive:	Flat (~DIN 1809)
	Shank size [mm]:	55.00
	Shank type:	BMT
	Tool adaption:	ER 25 A - u-tec
	Gear ratio [i]:	2:1
	Torque max [Nm]:	50
	Rotation max [1/min]:	3000
	Rotating direction:	opposite
	Coolant:	IC/Ext
	Pressure max [bar]:	140
	Please note:	stronger bearing
	Offset [mm]:	42

Part-#	Name	
8 019 56 038	Axial drilling and milling head C 4	
	Weight [kg]:	6.930
	Notation:	180° reversible
	Tool drive:	Flat (~DIN 1809)
	Shank size [mm]:	55.00
	Shank type:	BMT
	Tool adaption:	heimatec Capto(TM) C 4
	Gear ratio [i]:	1:1
	Torque max [Nm]:	50
	Rotation max [1/min]:	6000
	Rotating direction:	opposite
	Coolant:	EXT
	Please note:	Check applicability; note tool length!
	Offset [mm]:	62
8 019 56 042	Axial drilling and milling head C 4 IC	
	Weight [kg]:	7.720
	Notation:	180° reversible
	Tool drive:	Flat (~DIN 1809)
	Shank size [mm]:	55.00
	Shank type:	BMT
	Tool adaption:	heimatec Capto(TM) C 4
	Gear ratio [i]:	1:1
	Torque max [Nm]:	50
	Rotation max [1/min]:	6000
	Rotating direction:	opposite
	Coolant:	IC/Ext
	Pressure max [bar]:	140
	Please note:	Check applicability; note tool length!
	Offset [mm]:	62
8 019 56 057	Axial drilling and milling head C 4 IC	
	Weight [kg]:	7.650
	Notation:	180° reversible
	Tool drive:	Flat (~DIN 1809)
	Shank size [mm]:	55.00
	Shank type:	BMT
	Tool adaption:	heimatec Capto(TM) C 4
	Gear ratio [i]:	1:1
	Torque max [Nm]:	50
	Rotation max [1/min]:	12000
	Rotating direction:	opposite
	Coolant:	IC/Ext
	Pressure max [bar]:	140
	Please note:	Check applicability; note tool length!
	Offset [mm]:	62
8 030 53 005	Radial drilling and milling head ER 11	
	Weight [kg]:	5.210
	Notation:	180° reversible
	Tool drive:	Flat (~DIN 1809)
	Shank size [mm]:	55.00
	Shank type:	BMT
	Tool adaption:	ER 11
	Gear ratio [i]:	1:4
	Torque max [Nm]:	2,5

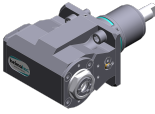
Part-#	Name	
	Rotation max [1/min]:	48000
	Rotating direction:	opposite
	Coolant:	EXT
	Please note:	Check applicability!
	Center distance [mm]:	65
8 030 54 001	Radial drilling and milling head ER 20	
	Weight [kg]:	4.750
	Tool drive:	Flat (~DIN 1809)
	Shank size [mm]:	55.00
	Shank type:	BMT
	Tool adaption:	ER 20
	Gear ratio [i]:	1:1
	Torque max [Nm]:	25
	Rotation max [1/min]:	6000
	Rotating direction:	opposite
	Coolant:	EXT
	Center distance [mm]:	55
8 030 54 049	Radial drilling and milling head ER 16 AX UT IC	
	Weight [kg]:	6.500
	Notation:	180° reversible
	Tool drive:	Flat (~DIN 1809)
	Shank size [mm]:	55.00
	Shank type:	BMT
	Tool adaption:	ER 16 A - u-tec
	Gear ratio [i]:	1:1
	Torque max [Nm]:	50
	Rotation max [1/min]:	6000
	Rotating direction:	opposite
	Coolant:	IC/Ext
	Pressure max [bar]:	140
	Please note:	Combi bearing; high pressure version
	Center distance [mm]:	65
8 030 54 050	Radial drilling and milling head ER 16 AX UT IC	
	Notation:	180° reversible
	Tool drive:	Flat (~DIN 1809)
	Shank size [mm]:	55.00
	Shank type:	BMT
	Tool adaption:	ER 16 A - u-tec
	Gear ratio [i]:	1:4
	Torque max [Nm]:	5
	Rotation max [1/min]:	24000
	Rotating direction:	opposite
	Coolant:	IC/Ext
	Pressure max [bar]:	140
	Center distance [mm]:	65
8 030 54 056	Radial drilling and milling head ER 20 AX UT IC	
	Weight [kg]:	5.320
	Tool drive:	Flat (~DIN 1809)
	Shank size [mm]:	55.00
	Shank type:	BMT
	Tool adaption:	ER 20 A - u-tec
	Gear ratio [i]:	1:1

Part-#	Name	
	Torque max [Nm]:	25
	Rotation max [1/min]:	6000
	Rotating direction:	opposite
	Coolant:	IC/Ext
	Pressure max [bar]:	140
	Please note:	Combi bearing
	Center distance [mm]:	55
8 030 54 064	Radial drilling and milling head ER 20 AX UT IC	
	Weight [kg]:	6.520
	Notation:	180° reversible
	Tool drive:	Flat (~DIN 1809)
	Shank size [mm]:	55.00
	Shank type:	BMT
	Tool adaption:	ER 20 A - u-tec
	Gear ratio [i]:	1:2
	Torque max [Nm]:	16
	Rotation max [1/min]:	12000
	Rotating direction:	same
	Coolant:	IC/Ext
	Pressure max [bar]:	140
	Please note:	stronger bearing
	Center distance [mm]:	77
8 030 55 004	Radial drilling and milling head ER 25 IC	
	Weight [kg]:	5.200
	Tool drive:	Flat (~DIN 1809)
	Shank size [mm]:	55.00
	Shank type:	BMT
	Tool adaption:	ER 25
	Gear ratio [i]:	1:1
	Torque max [Nm]:	25
	Rotation max [1/min]:	6000
	Rotating direction:	opposite
	Coolant:	IC/Ext
	Pressure max [bar]:	140
	Center distance [mm]:	55
8 030 55 007	Radial drilling and milling head ER 25	
	Weight [kg]:	4.770
	Tool drive:	Flat (~DIN 1809)
	Shank size [mm]:	55.00
	Shank type:	BMT
	Tool adaption:	ER 25
	Gear ratio [i]:	1:1
	Torque max [Nm]:	25
	Rotation max [1/min]:	6000
	Rotating direction:	opposite
	Coolant:	EXT
	Center distance [mm]:	55

Part-#

Name

8 030 55 063**Radial drilling and milling head ER 25 AX UT**

Notation: 180° reversible
 Tool drive: Flat (~DIN 1809)
 Shank size [mm]: 55.00
 Shank type: BMT
 Tool adaption: ER 25 A - u-tec
 Gear ratio [i]: 2:1
 Torque max [Nm]: 63
 Rotation max [1/min]: 6000
 Rotating direction: opposite
 Coolant: EXT
 Please note: Combi bearing
 Center distance [mm]: 65

8 030 55 087**Radial drilling and milling head Weldon 3/4"**



Weight [kg]: 6.690
 Notation: 180° reversible
 Tool drive: Flat (~DIN 1809)
 Shank size [mm]: 55.00
 Shank type: BMT
 Tool adaption: Weldon (DIN 1835 b) 3/4" (19,05mm)
 Gear ratio [i]: 1:1
 Torque max [Nm]: 50
 Rotation max [1/min]: 6000
 Rotating direction: opposite
 Coolant: EXT
 Please note: Combi bearing
 Center distance [mm]: 65

8 030 55 091**Angle-mill- and drill holder ER 25 AX UT IC**

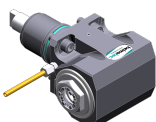
Weight [kg]: 6.680
 Notation: 180° reversible
 Tool drive: Flat (~DIN 1809)
 Shank size [mm]: 55.00
 Shank type: BMT
 Tool adaption: ER 25 A - u-tec
 Gear ratio [i]: 1:1
 Torque max [Nm]: 50
 Rotation max [1/min]: 6000
 Rotating direction: opposite
 Coolant: IC/Ext
 Pressure max [bar]: 140
 Please note: Combi bearing; high pressure version
 Center distance [mm]: 65

8 030 55 092**Angle-mill- and drill holder ER 25 AX UT**

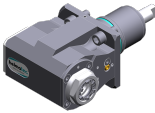
Weight [kg]: 6.320
 Notation: 180° reversible
 Tool drive: Flat (~DIN 1809)
 Shank size [mm]: 55.00
 Shank type: BMT
 Tool adaption: ER 25 A - u-tec
 Gear ratio [i]: 1:1
 Torque max [Nm]: 50
 Rotation max [1/min]: 6000
 Rotating direction: opposite

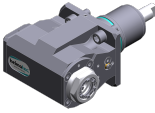
Part-#	Name	
		Coolant: EXT Please note: Combi bearing Center distance [mm]: 65
8 030 55 122	Radial drilling and milling head ER 25 AX UT	
	Weight [kg]: 6.380	
	Notation: 180° reversible	
	Tool drive: Flat (~DIN 1809)	
	Shank size [mm]: 55.00	
	Shank type: BMT	
	Tool adaption: ER 25 A - u-tec	
	Gear ratio [i]: 1:2	
	Torque max [Nm]: 16	
	Rotation max [1/min]: 12000	
	Rotating direction: same	
	Coolant: EXT	
	Please note: stronger bearing; check applicability;	
	Center distance [mm]: 77	
8 030 55 131	Radial drilling and milling head ER 25 AX UT	
	Weight [kg]: 4.980	
	Tool drive: Flat (~DIN 1809)	
	Shank size [mm]: 55.00	
	Shank type: BMT	
	Tool adaption: ER 25 A - u-tec	
	Gear ratio [i]: 1:1	
	Torque max [Nm]: 25	
	Rotation max [1/min]: 6000	
	Rotating direction: opposite	
	Coolant: EXT	
	Please note: stronger bearing	
	Center distance [mm]: 55	
8 030 55 139	Radial drilling and milling head ER 25 AX UT IC	
	Weight [kg]: 6.560	
	Notation: 180° reversible	
	Tool drive: Flat (~DIN 1809)	
	Shank size [mm]: 55.00	
	Shank type: BMT	
	Tool adaption: ER 25 A - u-tec	
	Gear ratio [i]: 1:3	
	Torque max [Nm]: 12	
	Rotation max [1/min]: 18000	
	Rotating direction: same	
	Coolant: IC/Ext	
	Pressure max [bar]: 140	
	Please note: stronger bearing	
	Center distance [mm]: 77	
8 030 55 140	Radial drilling and milling head ER 25 AX UT	
	Weight [kg]: 6.700	
	Notation: 180° reversible	
	Tool drive: Flat (~DIN 1809)	
	Shank size [mm]: 55.00	
	Shank type: BMT	
	Tool adaption: ER 25 A - u-tec	
	Gear ratio [i]: 1:3	

Part-#	Name	
	Torque max [Nm]:	12
	Rotation max [1/min]:	18000
	Rotating direction:	same
	Coolant:	EXT
	Please note:	stronger bearing
	Center distance [mm]:	77
8 030 55 154	Radial drilling and milling head ER 25 AX UT IC	
	Weight [kg]:	5.390
	Tool drive:	Flat (~DIN 1809)
	Shank size [mm]:	55.00
	Shank type:	BMT
	Tool adaption:	ER 25 A - u-tec
	Gear ratio [i]:	1:1
	Torque max [Nm]:	25
	Rotation max [1/min]:	6000
	Rotating direction:	opposite
	Coolant:	IC/Ext
	Pressure max [bar]:	140
	Please note:	High pressure version, stronger bearing
	Center distance [mm]:	55
8 030 55 158	Radial drilling and milling head C 3 IC	
	Weight [kg]:	8.280
	Notation:	180° reversible
	Tool drive:	Flat (~DIN 1809)
	Shank size [mm]:	55.00
	Shank type:	BMT
	Tool adaption:	heimatec Capto(TM) C 3
	Gear ratio [i]:	1:1
	Torque max [Nm]:	25
	Rotation max [1/min]:	8000
	Rotating direction:	opposite
	Coolant:	IC/Ext
	Pressure max [bar]:	140
	Please note:	Check applicability; note tool length!
	Center distance [mm]:	65
8 030 55 159	Radial drilling and milling head ER 25 AX UT	
	Weight [kg]:	7.710
	Notation:	180° reversible
	Tool drive:	Flat (~DIN 1809)
	Shank size [mm]:	55.00
	Shank type:	BMT
	Tool adaption:	ER 25 A - u-tec
	Gear ratio [i]:	1:3
	Torque max [Nm]:	12
	Rotation max [1/min]:	18000
	Rotating direction:	same
	Coolant:	EXT
	Please note:	stronger bearing
	Center distance [mm]:	107

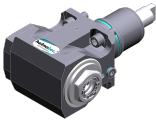
Part-#	Name	
8 030 55 216	Angle-mill- and drill holder ER 25 AX UT	
	Notation:	180° reversible
	Tool drive:	Flat (~DIN 1809)
	Shank size [mm]:	55.00
	Shank type:	BMT
	Tool adaption:	ER 25 A - u-tec
	Gear ratio [i]:	1:1
	Torque max [Nm]:	50
	Rotation max [1/min]:	6000
	Rotating direction:	opposite
	Coolant:	EXT
	Please note:	Combi bearing; check applicability
	Center distance [mm]:	95
8 030 55 217	Angle-mill- and drill holder ER 25 AX UT IC	
	Notation:	180° reversible
	Tool drive:	Flat (~DIN 1809)
	Shank size [mm]:	55.00
	Shank type:	BMT
	Tool adaption:	ER 25 A - u-tec
	Gear ratio [i]:	1:1
	Torque max [Nm]:	50
	Rotation max [1/min]:	6000
	Rotating direction:	opposite
	Coolant:	IC/Ext
	Pressure max [bar]:	140
	Please note:	Combi bearing; Einsetzbarkeit check!
	Center distance [mm]:	95
8 030 55 238	Radial drilling and milling head ER 25 AX UT	
	Weight [kg]:	6.100
	Notation:	180° reversible
	Tool drive:	Flat (~DIN 1809)
	Shank size [mm]:	55.00
	Shank type:	BMT
	Tool adaption:	ER 25 A - u-tec
	Gear ratio [i]:	1:1
	Torque max [Nm]:	50
	Rotation max [1/min]:	12000
	Rotating direction:	opposite
	Coolant:	EXT
	Center distance [mm]:	65
8 030 55 239	Radial drilling and milling head ER 25 AX UT IC	
	Weight [kg]:	6.470
	Notation:	180° reversible
	Tool drive:	Flat (~DIN 1809)
	Shank size [mm]:	55.00
	Shank type:	BMT
	Tool adaption:	ER 25 A - u-tec
	Gear ratio [i]:	1:1
	Torque max [Nm]:	50
	Rotation max [1/min]:	12000
	Rotating direction:	opposite
	Coolant:	IC/Ext
	Pressure max [bar]:	140

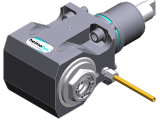
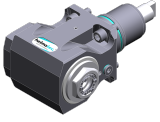
Part-#	Name	
	Center distance [mm]:	65
8 030 55 240	Radial drilling and milling head ER 25 AX UT	
	Weight [kg]:	6.380
	Notation:	180° reversible
	Tool drive:	Flat (~DIN 1809)
	Shank size [mm]:	55.00
	Shank type:	BMT
	Tool adaption:	ER 25 A - u-tec
	Gear ratio [i]:	1:1
	Torque max [Nm]:	50
	Rotation max [1/min]:	12000
	Rotating direction:	opposite
	Coolant:	EXT
	Center distance [mm]:	75
8 030 55 241	Angle drilling and milling head ER 25 AX UT IC	
	Weight [kg]:	6.960
	Notation:	180° reversible
	Tool drive:	Flat (~DIN 1809)
	Shank size [mm]:	55.00
	Shank type:	BMT
	Tool adaption:	ER 25 A - u-tec
	Gear ratio [i]:	1:1
	Torque max [Nm]:	50
	Rotation max [1/min]:	12000
	Rotating direction:	opposite
	Coolant:	IC/Ext
	Pressure max [bar]:	140
	Center distance [mm]:	75
8 030 55 244	Angle-mill- and drill holder ER 25 AS UT	
	Notation:	180° reversible
	Tool drive:	Flat (~DIN 1809)
	Shank size [mm]:	55.00
	Shank type:	BMT
	Tool adaption:	ER 25 A - u-tec
	Gear ratio [i]:	1:1
	Torque max [Nm]:	50
	Rotation max [1/min]:	6000
	Rotating direction:	opposite
	Coolant:	EXT
	Please note:	Combi bearing
	Center distance [mm]:	65
8 030 55 246	Radial drilling and milling head ER 25 AS UT	
	Notation:	180° reversible
	Tool drive:	Flat (~DIN 1809)
	Shank size [mm]:	55.00
	Shank type:	BMT
	Tool adaption:	ER 25 A - u-tec
	Gear ratio [i]:	1:1
	Torque max [Nm]:	50
	Rotation max [1/min]:	12000
	Rotating direction:	opposite
	Coolant:	EXT
	Center distance [mm]:	65

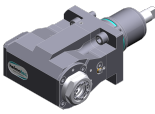
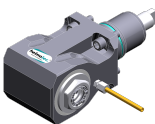
Part-#	Name	
8 030 55 247	Radial drilling and milling head ER 25 AS UT IC	
	Notation:	180° reversible
	Tool drive:	Flat (~DIN 1809)
	Shank size [mm]:	55.00
	Shank type:	BMT
	Tool adaption:	ER 25 A - u-tec
	Gear ratio [i]:	1:1
	Torque max [Nm]:	50
	Rotation max [1/min]:	12000
	Rotating direction:	opposite
	Coolant:	IC/Ext
	Pressure max [bar]:	140
	Center distance [mm]:	65
8 030 55 250	Radial drilling and milling head ER 25 AX UT IC	
	Weight [kg]:	8.170
	Notation:	180° reversible
	Tool drive:	Flat (~DIN 1809)
	Shank size [mm]:	55.00
	Shank type:	BMT
	Tool adaption:	ER 25 A - u-tec
	Gear ratio [i]:	1:1
	Torque max [Nm]:	50
	Rotation max [1/min]:	12000
	Rotating direction:	opposite
	Coolant:	IC/Ext
	Pressure max [bar]:	140
	Please note:	Check applicability; note tool length!
	Center distance [mm]:	100
8 030 55 251	Radial drilling and milling head ER 25 AX UT IC	
	Weight [kg]:	7.520
	Notation:	180° reversible
	Tool drive:	Flat (~DIN 1809)
	Shank size [mm]:	55.00
	Shank type:	BMT
	Tool adaption:	ER 25 A - u-tec
	Gear ratio [i]:	1:2
	Torque max [Nm]:	16
	Rotation max [1/min]:	16000
	Rotating direction:	same
	Coolant:	IC/Ext
	Pressure max [bar]:	140
	Please note:	stronger bearing; check applicability;
	Center distance [mm]:	100
8 030 55 262	Radial drilling and milling head ER 25 AX UT	
	Weight [kg]:	7.500
	Notation:	180° reversible
	Tool drive:	Flat (~DIN 1809)
	Shank size [mm]:	55.00
	Shank type:	BMT
	Tool adaption:	ER 25 A - u-tec
	Gear ratio [i]:	1:1
	Torque max [Nm]:	50
	Rotation max [1/min]:	12000
	Rotating direction:	opposite

Part-#	Name
--------	------

Coolant: EXT
Please note: Check applicability!
Center distance [mm]: 95

8 030 55 263 Radial drilling and milling head ER 25 AX UT IC

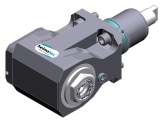

Weight [kg]: 7.980
Notation: 180° reversible
Tool drive: Flat (~DIN 1809)
Shank size [mm]: 55.00
Shank type: BMT
Tool adaption: ER 25 A - u-tec
Gear ratio [i]: 1:1
Torque max [Nm]: 50
Rotation max [1/min]: 12000
Rotating direction: opposite
Coolant: IC/Ext
Pressure max [bar]: 140
Please note: Check applicability!
Center distance [mm]: 95

8 030 56 013 Radial drilling and milling head HT 4

Weight [kg]: 4.620
Tool drive: Flat (~DIN 1809)
Shank size [mm]: 55.00
Shank type: BMT
Tool adaption: HT 4
Gear ratio [i]: 1:1
Torque max [Nm]: 25
Rotation max [1/min]: 6000
Rotating direction: opposite
Coolant: EXT
Center distance [mm]: 55

8 030 56 059 Radial drilling and milling head HT 4 IC

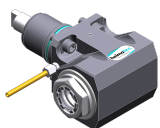

Notation: 180° reversible
Version: long
Tool drive: Flat (~DIN 1809)
Shank size [mm]: 55.00
Shank type: BMT
Tool adaption: HT 4
Gear ratio [i]: 2:1
Torque max [Nm]: 63
Rotation max [1/min]: 3000
Rotating direction: opposite
Coolant: IC/Ext
Pressure max [bar]: 140
Please note: Combi bearing
Center distance [mm]: 65

8 030 56 070 Radial drilling and milling head ER 32 AX UT



Notation: 180° reversible
Tool drive: Flat (~DIN 1809)
Shank size [mm]: 55.00
Shank type: BMT
Tool adaption: ER 32 A - u-tec
Gear ratio [i]: 2:1
Torque max [Nm]: 63

Part-#	Name	
	Rotation max [1/min]:	6000
	Rotating direction:	opposite
	Coolant:	EXT
	Please note:	Combi bearing
	Center distance [mm]:	65
8 030 56 075	Radial drilling and milling head HT 4 IC	
	Weight [kg]:	6.580
	Notation:	180° reversible
	Tool drive:	Flat (~DIN 1809)
	Shank size [mm]:	55.00
	Shank type:	BMT
	Tool adaption:	HT 4
	Gear ratio [i]:	1:1
	Torque max [Nm]:	50
	Rotation max [1/min]:	6000
	Rotating direction:	opposite
	Coolant:	IC/Ext
	Pressure max [bar]:	140
	Please note:	Combi bearing
	Center distance [mm]:	65
8 030 56 090	Radial drilling and milling head ER 32 AX UT IC	
	Notation:	180° reversible
	Tool drive:	Flat (~DIN 1809)
	Shank size [mm]:	55.00
	Shank type:	BMT
	Tool adaption:	ER 32 A - u-tec
	Gear ratio [i]:	2:1
	Torque max [Nm]:	63
	Rotation max [1/min]:	6000
	Rotating direction:	opposite
	Coolant:	IC/Ext
	Pressure max [bar]:	140
	Please note:	Combi bearing
	Center distance [mm]:	65
8 030 56 095	Angle-mill- and drill holder ER 32 AX UT	
	Weight [kg]:	6.320
	Notation:	180° reversible
	Tool drive:	Flat (~DIN 1809)
	Shank size [mm]:	55.00
	Shank type:	BMT
	Tool adaption:	ER 32 A - u-tec
	Gear ratio [i]:	1:1
	Torque max [Nm]:	50
	Rotation max [1/min]:	6000
	Rotating direction:	opposite
	Coolant:	EXT
	Please note:	Combi bearing
	Center distance [mm]:	65

Part-#	Name	
8 030 56 096	Angle-mill- and drill holder ER 32 AX UT IC	
	Weight [kg]:	6.700
	Notation:	180° reversible
	Tool drive:	Flat (~DIN 1809)
	Shank size [mm]:	55.00
	Tool adaption:	ER 32 A - u-tec
	Gear ratio [i]:	1:1
	Torque max [Nm]:	50
	Rotation max [1/min]:	6000
	Rotating direction:	opposite
	Coolant:	IC/Ext
	Pressure max [bar]:	140
	Please note:	Combi bearing
	Center distance [mm]:	65
8 030 56 176	Radial drilling and milling head C 4	
	Notation:	180° reversible
	Tool drive:	Flat (~DIN 1809)
	Shank size [mm]:	55.00
	Shank type:	BMT
	Tool adaption:	heimatec Capto(TM) C 4
	Gear ratio [i]:	1:1
	Torque max [Nm]:	40
	Rotation max [1/min]:	6000
	Rotating direction:	opposite
	Coolant:	EXT
	Pressure max [bar]:	140
	Please note:	Check applicability; note tool length!
	Center distance [mm]:	65
8 030 56 177	Radial drilling and milling head C 4 IC	
	Weight [kg]:	9.780
	Notation:	180° reversible
	Tool drive:	Flat (~DIN 1809)
	Shank size [mm]:	55.00
	Shank type:	BMT
	Tool adaption:	heimatec Capto(TM) C 4
	Gear ratio [i]:	1:1
	Torque max [Nm]:	40
	Rotation max [1/min]:	6000
	Rotating direction:	opposite
	Coolant:	IC/Ext
	Pressure max [bar]:	140
	Please note:	Check applicability; note tool length!
	Center distance [mm]:	65
8 030 56 214	Radial drilling and milling head C 4 IC	
	Notation:	180° reversible
	Tool drive:	Flat (~DIN 1809)
	Shank size [mm]:	55.00
	Shank type:	BMT
	Tool adaption:	heimatec Capto(TM) C 4
	Gear ratio [i]:	1:1
	Torque max [Nm]:	63
	Rotation max [1/min]:	12000
	Rotating direction:	opposite
	Coolant:	IC/Ext

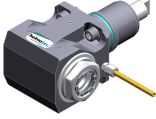
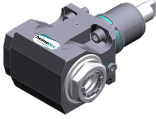
Part-#	Name	
	Pressure max [bar]:	140
	Please note:	Check applicability; note tool length!
	Center distance [mm]:	65
8 030 56 215	Radial drilling and milling head C 4	
	Notation:	180° reversible
	Tool drive:	Flat (~DIN 1809)
	Shank size [mm]:	55.00
	Shank type:	BMT
	Tool adaption:	heimatec Capto(TM) C 4
	Gear ratio [i]:	1:1
	Torque max [Nm]:	63
	Rotation max [1/min]:	12000
	Rotating direction:	opposite
	Coolant:	EXT
	Please note:	Check applicability; note tool length!
	Center distance [mm]:	65
8 030 56 216	Radial drilling and milling head Weldon 20 IC	
	Weight [kg]:	7.040
	Notation:	180° reversible
	Tool drive:	Flat (~DIN 1809)
	Shank size [mm]:	55.00
	Shank type:	BMT
	Tool adaption:	Weldon (DIN 1835 b) 20
	Gear ratio [i]:	1:1
	Torque max [Nm]:	50
	Rotation max [1/min]:	12000
	Rotating direction:	opposite
	Coolant:	IC/Ext
	Pressure max [bar]:	140
	Please note:	stronger bearing; high pressure version
	Center distance [mm]:	65
8 030 56 235	Radial drilling and milling head ER 32 AX UT	
	Weight [kg]:	6.050
	Notation:	180° reversible
	Tool drive:	Flat (~DIN 1809)
	Shank size [mm]:	55.00
	Shank type:	BMT
	Tool adaption:	ER 32 A - u-tec
	Gear ratio [i]:	1:1
	Torque max [Nm]:	50
	Rotation max [1/min]:	12000
	Rotating direction:	opposite
	Coolant:	EXT
	Center distance [mm]:	65
8 030 56 236	Radial drilling and milling head ER 32 AX UT IC	
	Weight [kg]:	5.830
	Notation:	180° reversible
	Tool drive:	Flat (~DIN 1809)
	Shank size [mm]:	55.00
	Shank type:	BMT
	Tool adaption:	ER 32 A - u-tec
	Gear ratio [i]:	1:1
	Torque max [Nm]:	50

Part-#

Name

Rotation max [1/min]: 12000
 Rotating direction: opposite
 Coolant: IC/Ext
 Pressure max [bar]: 140
 Center distance [mm]: 65

8 030 56 237

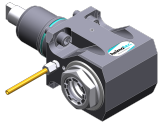
Radial drilling and milling head ER 32 AX UT

Weight [kg]: 6.500
 Notation: 180° reversible
 Tool drive: Flat (~DIN 1809)
 Shank size [mm]: 55.00
 Shank type: BMT
 Tool adaption: ER 32 A - u-tec
 Gear ratio [i]: 1:1
 Torque max [Nm]: 50
 Rotation max [1/min]: 12000
 Rotating direction: opposite
 Coolant: EXT
 Center distance [mm]: 75

8 030 56 238



Radial drilling and milling head ER 32 AX UT IC

Weight [kg]: 7.200
 Notation: 180° reversible
 Tool drive: Flat (~DIN 1809)
 Shank size [mm]: 55.00
 Shank type: BMT
 Tool adaption: ER 32 A - u-tec
 Gear ratio [i]: 1:1
 Torque max [Nm]: 50
 Rotation max [1/min]: 12000
 Rotating direction: opposite
 Coolant: IC/Ext
 Pressure max [bar]: 140
 Center distance [mm]: 75

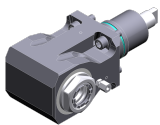
8 030 56 239

Radial drilling and milling head ER 32 AX UT

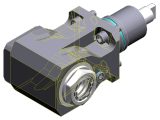
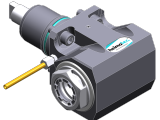
Weight [kg]: 7.500
 Notation: 180° reversible
 Tool drive: Flat (~DIN 1809)
 Shank size [mm]: 55.00
 Shank type: BMT
 Tool adaption: ER 32 A - u-tec
 Gear ratio [i]: 1:1
 Torque max [Nm]: 50
 Rotation max [1/min]: 12000
 Rotating direction: opposite
 Coolant: EXT
 Please note: Check applicability!
 Center distance [mm]: 95

Part-#	Name	
	8 030 56 240	Radial drilling and milling head ER 32 AX UT IC
	Weight [kg]:	7.960
	Notation:	180° reversible
	Tool drive:	Flat (~DIN 1809)
	Shank size [mm]:	55.00
	Shank type:	BMT
	Tool adaption:	ER 32 A - u-tec
	Gear ratio [i]:	1:1
	Torque max [Nm]:	50
	Rotation max [1/min]:	12000
	Rotating direction:	opposite
	Coolant:	IC/Ext
	Pressure max [bar]:	140
	Please note:	Check applicability!
Center distance [mm]:	95	
	8 030 56 249	Radial drilling and milling head HT 4 IC
	Weight [kg]:	6.580
	Notation:	180° reversible
	Tool drive:	Flat (~DIN 1809)
	Shank size [mm]:	55.00
	Shank type:	BMT
	Tool adaption:	HT 4
	Gear ratio [i]:	1:1
	Torque max [Nm]:	50
	Rotation max [1/min]:	12000
	Rotating direction:	opposite
	Coolant:	IC/Ext
	Pressure max [bar]:	140
	Center distance [mm]:	65
	8 030 56 271	Radial drilling and milling head ER 32 AX UT
	Weight [kg]:	6.380
	Notation:	180° reversible
	Tool drive:	Flat (~DIN 1809)
	Shank size [mm]:	55.00
	Shank type:	BMT
	Tool adaption:	ER 32 A - u-tec
	Gear ratio [i]:	1:1
	Torque max [Nm]:	50
	Rotation max [1/min]:	12000
	Rotating direction:	opposite
	Coolant:	EXT
	Pressure max [bar]:	140
	Please note:	stronger bearing
Center distance [mm]:	65	
	8 030 56 275	Radial drilling and milling head ER 32 AX UT IC
	Weight [kg]:	6.700
	Notation:	180° reversible
	Tool drive:	Flat (~DIN 1809)
	Shank size [mm]:	55.00
	Shank type:	BMT
	Tool adaption:	ER 32 A - u-tec
	Gear ratio [i]:	1:1
	Torque max [Nm]:	50
	Rotation max [1/min]:	12000

Part-#	Name	
	Rotating direction:	opposite
	Coolant:	IC/Ext
	Pressure max [bar]:	140
	Please note:	stronger bearing
	Center distance [mm]:	65
8 030 57 044	Radial drilling and milling head Weldon 25 IC	
	Weight [kg]:	7.150
	Notation:	180° reversible
	Tool drive:	Flat (~DIN 1809)
	Shank size [mm]:	55.00
	Shank type:	BMT
	Tool adaption:	Weldon (DIN 1835 b) 25
	Gear ratio [i]:	1:1
	Torque max [Nm]:	50
	Rotation max [1/min]:	6000
	Rotating direction:	opposite
	Coolant:	IC/Ext
	Pressure max [bar]:	140
	Please note:	Combi bearing
	Center distance [mm]:	65
8 030 57 120	Radial drilling and milling head ER 40 AX UT	
	Notation:	180° reversible
	Tool drive:	Flat (~DIN 1809)
	Shank size [mm]:	55.00
	Shank type:	BMT
	Tool adaption:	ER 40 A - u-tec
	Gear ratio [i]:	1:1
	Torque max [Nm]:	50
	Rotation max [1/min]:	6000
	Rotating direction:	opposite
	Coolant:	EXT
	Please note:	stronger bearing
	Center distance [mm]:	65
8 031 54 014	Radial milling head universal arbor 16	
	Weight [kg]:	6.500
	Notation:	180° reversible
	Tool drive:	Flat (~DIN 1809)
	Shank size [mm]:	55.00
	Shank type:	BMT
	Tool adaption:	Universal arbor 16
	Gear ratio [i]:	1:1
	Torque max [Nm]:	50
	Rotation max [1/min]:	6000
	Rotating direction:	opposite
	Coolant:	EXT
	Please note:	Combi bearing
	Center distance [mm]:	65

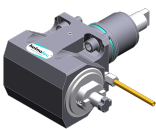

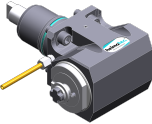
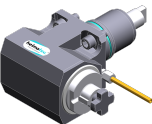
Part-#	Name	
8 031 54 015	Radial polygon head arbor 16	
		Weight [kg]: 6.650 Notation: 180° reversible Tool drive: Flat (~DIN 1809) Shank size [mm]: 55.00 Shank type: BMT Tool adaption: Polygon arbor 16 Gear ratio [i]: 1:1 Torque max [Nm]: 50 Rotation max [1/min]: 6000 Rotating direction: opposite Coolant: EXT Please note: Combi bearing Center distance [mm]: 65
8 031 56 010	Radial polygon head arbor 27	
		Notation: 180° reversible Tool drive: Flat (~DIN 1809) Shank size [mm]: 55.00 Shank type: BMT Tool adaption: Polygon arbor 27 Gear ratio [i]: 1:1 Torque max [Nm]: 50 Rotation max [1/min]: 6000 Rotating direction: opposite Coolant: EXT Please note: Combi bearing Center distance [mm]: 65
8 031 56 012	Radial milling head universal arbor 27	
		Weight [kg]: 6.560 Notation: 180° reversible Tool drive: Flat (~DIN 1809) Shank size [mm]: 55.00 Shank type: BMT Tool adaption: Universal arbor 27 Gear ratio [i]: 1:1 Torque max [Nm]: 50 Rotation max [1/min]: 6000 Rotating direction: opposite Coolant: EXT Please note: Combi bearing Center distance [mm]: 65
8 031 56 022	Radial milling head universal arbor 27	
		Notation: 180° reversible Tool drive: Flat (~DIN 1809) Shank size [mm]: 55.00 Shank type: BMT Tool adaption: Universal arbor 27 Gear ratio [i]: 2:1 Torque max [Nm]: 63 Rotation max [1/min]: 3000 Rotating direction: opposite Coolant: EXT Please note: Combi bearing Center distance [mm]: 65

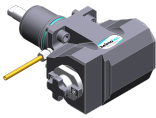
Part-#	Name		
	8 031 56 026	Radial milling head arbor 27	
		Notation:	180° reversible
		Tool drive:	Flat (~DIN 1809)
		Shank size [mm]:	55.00
		Shank type:	BMT
		Tool adaption:	Arbor 27
		Gear ratio [i]:	2:1
		Torque max [Nm]:	63
		Rotation max [1/min]:	3000
		Rotating direction:	opposite
		Coolant:	EXT
		Please note:	Combi bearing
		Center distance [mm]:	65
8 037 52 000	Woodruff keycutter for disk mill arbor 10		
		Tool drive:	Flat (~DIN 1809)
		Shank size [mm]:	55.00
		Shank type:	BMT
		Tool adaption:	Arbor 10
		Gear ratio [i]:	1,333:1
		Torque max [Nm]:	32
		Rotation max [1/min]:	2250
8 037 52 002	Radial disk mill head arbor 10		
		Weight [kg]:	6.900
		Tool drive:	Flat (~DIN 1809)
		Shank size [mm]:	55.00
		Shank type:	BMT
		Tool adaption:	Arbor 10
		Gear ratio [i]:	2:1
		Torque max [Nm]:	32
		Rotation max [1/min]:	3000
		Rotating direction:	opposite
8 037 53 001	Radial disk mill head arbor 13		
		Weight [kg]:	6.960
		Tool drive:	Flat (~DIN 1809)
		Shank size [mm]:	55.00
		Shank type:	BMT
		Tool adaption:	Arbor 13
		Gear ratio [i]:	2:1
		Torque max [Nm]:	32
		Rotation max [1/min]:	3000
		Rotating direction:	opposite
	Coolant:	no	
	Center distance [mm]:	76	

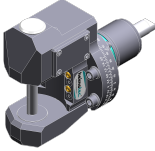
Part-#	Name		
	8 037 53 007	Radial disk mill head arbor 1/2"	
		Weight [kg]:	6.750
		Version:	360° turnable
		Tool drive:	Flat (~DIN 1809)
		Shank size [mm]:	55.00
		Shank type:	BMT
		Tool adaption:	Arbor 1/2" (12,7mm)
		Gear ratio [i]:	1:1
		Torque max [Nm]:	50
		Rotation max [1/min]:	4000
		Rotating direction:	opposite
		Coolant:	EXT
		Center distance [mm]:	90
		8 039 54 029	Radial milling head arbor 16
		Weight [kg]:	9.600
		Notation:	offset; 180° reversible
		Version:	Special; ±45° turnable
		Tool drive:	Flat (~DIN 1809)
		Shank size [mm]:	55.00
		Shank type:	BMT
		Tool adaption:	Arbor 16
		Gear ratio [i]:	1:1
		Torque max [Nm]:	50
		Rotation max [1/min]:	6000
		Rotating direction:	same
		Coolant:	EXT
		Please note:	stronger bearing
	Center distance [mm]:	91	
	8 039 56 009	Radial drilling and milling head HT 4	
		Weight [kg]:	6.600
		Notation:	180° reversible
		Employment for:	Main- and sub spindle
		Version:	double spindle
		Tool drive:	Flat (~DIN 1809)
		Shank size [mm]:	55.00
		Shank type:	BMT
		Tool adaption:	HT 4
		Gear ratio [i]:	1:1
		Torque max [Nm]:	50
		Rotation max [1/min]:	12000
		Rotating direction:	same/opposite
		Coolant:	EXT
	Please note:	stronger bearing	
	Center distance [mm]:	65	
	8 039 56 038	Radial drilling and milling head ER 32 AX UT IC	
		Notation:	offset; 180° reversible
		Version:	± 45° turnable
		Tool drive:	Flat (~DIN 1809)
		Shank size [mm]:	55.00
		Shank type:	BMT
		Tool adaption:	ER 32 A - u-tec
		Gear ratio [i]:	1:1
		Torque max [Nm]:	50
		Rotation max [1/min]:	6000
		Rotating direction:	same

Part-#	Name	
	Coolant:	IC/Ext
	Pressure max [bar]:	140
	Please note:	stronger bearing
	Center distance [mm]:	91
8 039 56 040	Radial drilling and milling head ER 32 AX UT	
	Weight [kg]:	9.360
	Notation:	offset; 180° reversible
	Version:	± 45° turnable
	Tool drive:	Flat (~DIN 1809)
	Shank size [mm]:	55.00
	Shank type:	BMT
	Tool adaption:	ER 32 A - u-tec
	Gear ratio [i]:	1:1
	Torque max [Nm]:	50
	Rotation max [1/min]:	6000
	Rotating direction:	same
	Coolant:	EXT
	Please note:	stronger bearing
	Center distance [mm]:	91
8 039 56 041	Radial drilling and milling head hydro 20	
	Weight [kg]:	9.680
	Notation:	offset; 180° reversible
	Version:	± 45° turnable
	Tool drive:	Flat (~DIN 1809)
	Shank size [mm]:	55.00
	Shank type:	BMT
	Tool adaption:	Hydro clamp Ø 20
	Gear ratio [i]:	1:1
	Torque max [Nm]:	50
	Rotation max [1/min]:	6000
	Rotating direction:	same
	Coolant:	EXT
	Please note:	stronger bearing
	Center distance [mm]:	91
8 040 53 000	Universal head ± 90° adjustable ER 11 AX	
	Weight [kg]:	3.150
	Tool drive:	Flat (~DIN 1809)
	Shank size [mm]:	55.00
	Shank type:	BMT
	Tool adaption:	ER 11 A
	Gear ratio [i]:	1:1
	Torque max [Nm]:	10
	Rotation max [1/min]:	5000
	Rotating direction:	same
	Coolant:	EXT
	Center distance [mm]:	57
8 040 53 001	Universal head ± 90° adjustable ER 11 AX	
	Weight [kg]:	2.900
	Tool drive:	Flat (~DIN 1809)
	Shank size [mm]:	55.00
	Shank type:	BMT
	Tool adaption:	ER 11 A
	Gear ratio [i]:	1:1
	Torque max [Nm]:	10

Nakamura
AS-200L - 12 Stationen

Part-#	Name	
	Rotation max [1/min]:	6000
	Rotating direction:	same
	Coolant:	EXT
	Center distance [mm]:	57
8 040 53 002	Universal head ± 90° adjustable ER 11 AX	
	Weight [kg]:	2.880
	Tool drive:	Flat (~DIN 1809)
	Shank size [mm]:	55.00
	Shank type:	BMT
	Tool adaption:	ER 11 A
	Gear ratio [i]:	1:1
	Torque max [Nm]:	10
	Rotation max [1/min]:	6000
	Rotating direction:	same
	Coolant:	EXT
8 040 53 003	Universal head ± 90° adjustable ER 11 AX	
	Weight [kg]:	3.160
	Tool drive:	Flat (~DIN 1809)
	Shank size [mm]:	55.00
	Shank type:	BMT
	Tool adaption:	ER 11 A
	Gear ratio [i]:	1:1
	Torque max [Nm]:	10
	Rotation max [1/min]:	6000
	Rotating direction:	same
	Coolant:	EXT
	Center distance [mm]:	57
8 040 54 002	Universal head ± 90° adjustable ER 16	
	Weight [kg]:	3.180
	Tool drive:	Flat (~DIN 1809)
	Shank size [mm]:	55.00
	Shank type:	BMT
	Tool adaption:	ER 16
	Gear ratio [i]:	1:1
	Torque max [Nm]:	10
	Rotation max [1/min]:	6000
	Rotating direction:	same
	Coolant:	EXT
	Center distance [mm]:	57
8 040 54 006	Universal head ± 90° adjustable ER 16	
	Weight [kg]:	3.180
	Tool drive:	Flat (~DIN 1809)
	Shank size [mm]:	55.00
	Shank type:	BMT
	Tool adaption:	ER 16
	Gear ratio [i]:	1:1
	Torque max [Nm]:	10
	Rotation max [1/min]:	6000
	Rotating direction:	same
	Coolant:	EXT
	Center distance [mm]:	57

Part-#	Name	
8 040 54 007	Universal head ± 90° adjustable ER 16	
	Weight [kg]:	3.180
	Tool drive:	Flat (~DIN 1809)
	Shank size [mm]:	55.00
	Shank type:	BMT
	Tool adaption:	ER 16
	Gear ratio [i]:	1:1
	Torque max [Nm]:	10
	Rotation max [1/min]:	6000
	Rotating direction:	same
	Coolant:	EXT
	Center distance [mm]:	57
8 040 54 008	Universal head ± 90° adjustable ER 16	
	Weight [kg]:	3.180
	Tool drive:	Flat (~DIN 1809)
	Shank size [mm]:	55.00
	Shank type:	BMT
	Tool adaption:	ER 16
	Gear ratio [i]:	1:1
	Torque max [Nm]:	10
	Rotation max [1/min]:	6000
	Rotating direction:	same
	Coolant:	EXT
	Center distance [mm]:	57
8 040 54 009	Universal head ± 90° adjustable ER 16	
	Version:	Special
	Tool drive:	Flat (~DIN 1809)
	Shank size [mm]:	55.00
	Shank type:	BMT
	Tool adaption:	ER 16
	Gear ratio [i]:	1:1
	Torque max [Nm]:	10
	Rotation max [1/min]:	6000
	Rotating direction:	same
	Coolant:	EXT
	Center distance [mm]:	57
8 040 54 012	Universal head ± 90° adjustable HT 2	
	Version:	75° position can be pinned
	Tool drive:	Flat (~DIN 1809)
	Shank size [mm]:	55.00
	Shank type:	BMT
	Tool adaption:	HT 2
	Gear ratio [i]:	1:1
	Torque max [Nm]:	10
	Rotation max [1/min]:	6000
	Rotating direction:	same
	Coolant:	EXT
	Center distance [mm]:	57

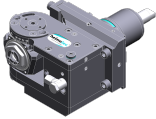
Part-#	Name
8 040 54 033	Universal head $\pm 90^\circ$ adjustable ER 16 AS UT IC
	Weight [kg]: 3.320 Tool drive: Flat (~DIN 1809) Shank size [mm]: 55.00 Shank type: BMT Tool adaption: ER 16 A - u-tec Gear ratio [i]: 1:1 Torque max [Nm]: 16 Rotation max [1/min]: 12000 Rotating direction: same Coolant: IC/Ext Pressure max [bar]: 140 Please note: Check applicability; note center distance! Center distance [mm]: 46
8 043 54 000	Universal head $+135^\circ/-30^\circ$ adj. ER16 AX UT
	Weight [kg]: 9.850 Notation: offset; 180° reversible Tool drive: Flat (~DIN 1809) Shank size [mm]: 55.00 Shank type: BMT Tool adaption: ER 16 A - u-tec Gear ratio [i]: 1:1 Torque max [Nm]: 25 Rotation max [1/min]: 6000 Rotating direction: same Coolant: EXT Center distance [mm]: 69 Offset [mm]: 60
8 043 54 001	Universal head $+135^\circ/-30^\circ$ adj. ER16AX UTIK
	Weight [kg]: 9.920 Notation: offset; 180° reversible Tool drive: Flat (~DIN 1809) Shank size [mm]: 55.00 Shank type: BMT Tool adaption: ER 16 A - u-tec Gear ratio [i]: 1:1 Torque max [Nm]: 25 Rotation max [1/min]: 6000 Rotating direction: same Coolant: IC/Ext Pressure max [bar]: 140 Center distance [mm]: 69 Offset [mm]: 60
8 043 54 002	Universal head $+135^\circ/-30^\circ$ adj. ER16 AX UT
	Weight [kg]: 9.930 Notation: offset; 180° reversible Tool drive: Flat (~DIN 1809) Shank size [mm]: 55.00 Shank type: BMT Tool adaption: ER 16 A - u-tec Gear ratio [i]: 1:2 Torque max [Nm]: 12 Rotation max [1/min]: 12000 Rotating direction: same

Part-#	Name	
	Coolant:	EXT
	Center distance [mm]:	69
	Offset [mm]:	60
8 043 54 003	Universal head +135°/-30° adj. ER16AX UTIK	
	Weight [kg]:	9.900
	Notation:	offset
	Tool drive:	Flat (~DIN 1809)
	Shank size [mm]:	55.00
	Shank type:	BMT
	Tool adaption:	ER 16 A - u-tec
	Gear ratio [i]:	1:2
	Torque max [Nm]:	12
	Rotation max [1/min]:	12000
	Rotating direction:	same
	Coolant:	IC/Ext
	Pressure max [bar]:	140
	Please note:	180° reversible
	Center distance [mm]:	69
	Offset [mm]:	60
8 043 54 004	Universal head +135°/-30° adj. ER20 AX UT	
	Weight [kg]:	10.010
	Notation:	offset; 180° reversible
	Tool drive:	Flat (~DIN 1809)
	Shank size [mm]:	55.00
	Shank type:	BMT
	Tool adaption:	ER 20 A - u-tec
	Gear ratio [i]:	1:1
	Torque max [Nm]:	25
	Rotation max [1/min]:	6000
	Rotating direction:	same
	Coolant:	EXT
	Please note:	stronger bearing
	Center distance [mm]:	69
	Offset [mm]:	60
8 043 54 019	Universal head +160°/-20° adj. ER16 AX UT	
	Weight [kg]:	6.100
	Notation:	offset; 180° reversible
	Tool drive:	Flat (~DIN 1809)
	Shank size [mm]:	55.00
	Shank type:	BMT
	Tool adaption:	ER 16 A - u-tec
	Gear ratio [i]:	1:1
	Torque max [Nm]:	25
	Rotation max [1/min]:	6000
	Rotating direction:	same
	Coolant:	EXT
	Center distance [mm]:	35
	Offset [mm]:	65

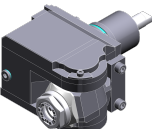
Part-#	Name	
8 043 54 034	Universal head $\pm 10^\circ$ adjustable ER 16 AX UT IC	
	Notation:	offset; 180° reversible
	Tool drive:	Flat (~DIN 1809)
	Shank size [mm]:	55.00
	Shank type:	BMT
	Tool adaption:	ER 16 A - u-tec
	Gear ratio [i]:	1:2
	Torque max [Nm]:	25
	Rotation max [1/min]:	12000
	Rotating direction:	same
	Coolant:	IC/Ext
	Pressure max [bar]:	140
	Please note:	Check applicability! note swivel range;
	Center distance [mm]:	62
	Offset [mm]:	48,5
8 043 55 001	Universal head $+135^\circ/-30^\circ$ adj. ER25 AX UT	
	Weight [kg]:	10.060
	Notation:	offset; 180° reversible
	Tool drive:	Flat (~DIN 1809)
	Shank size [mm]:	55.00
	Shank type:	BMT
	Tool adaption:	ER 25 A - u-tec
	Gear ratio [i]:	1:1
	Torque max [Nm]:	25
	Rotation max [1/min]:	6000
	Rotating direction:	same
	Coolant:	EXT
	Please note:	stronger bearing
	Center distance [mm]:	69
	Offset [mm]:	60
8 043 55 021	Universal head $+150^\circ/-15^\circ$ adj. ER25 AX UT	
	Weight [kg]:	6.410
	Notation:	offset; 180° reversible
	Version:	at 55° position can be pinned
	Tool drive:	Flat (~DIN 1809)
	Shank size [mm]:	55.00
	Shank type:	BMT
	Tool adaption:	ER 25 A - u-tec
	Gear ratio [i]:	1:1
	Torque max [Nm]:	25
	Rotation max [1/min]:	6000
	Rotating direction:	opposite
	Coolant:	EXT
	Please note:	stronger bearing
	Center distance [mm]:	35
	Offset [mm]:	65
8 043 55 022	Universal head $+135^\circ/-30^\circ$ adj. ER25AX UTIK	
	Weight [kg]:	10.080
	Notation:	offset; 180° reversible
	Tool drive:	Flat (~DIN 1809)
	Shank size [mm]:	55.00
	Shank type:	BMT
	Tool adaption:	ER 25 A - u-tec
	Gear ratio [i]:	1:1

Nakamura
AS-200L - 12 Stationen

Part-#	Name	
	Torque max [Nm]:	25
	Rotation max [1/min]:	6000
	Rotating direction:	same
	Coolant:	IC/Ext
	Pressure max [bar]:	140
	Please note:	stronger bearing
	Center distance [mm]:	69
	Offset [mm]:	60
8 050 54 005	Multispindle drilling head ER 16 AX UT	
	Weight [kg]:	6.100
	Notation:	offset
	Version:	2-spindles
	Tool drive:	Flat (~DIN 1809)
	Shank size [mm]:	55.00
	Shank type:	BMT
	Tool adaption:	ER 16 A - u-tec
	Gear ratio [i]:	1:2
	Torque max [Nm]:	16
	Rotation max [1/min]:	12000
	Rotating direction:	same
	Coolant:	EXT
	Offset [mm]:	56
8 050 54 008	Multispindle drilling head ER 16 AX UT	
	Weight [kg]:	5.700
	Notation:	offset
	Version:	2-spindles
	Tool drive:	Flat (~DIN 1809)
	Shank size [mm]:	55.00
	Tool adaption:	ER 16 A - u-tec
	Gear ratio [i]:	1:1
	Torque max [Nm]:	25
	Rotation max [1/min]:	6000
	Rotating direction:	same
	Coolant:	EXT
8 050 54 014	Multispindle drilling head ER 20 AX UT IC	
	Weight [kg]:	5.920
	Notation:	offset
	Version:	2-spindles
	Tool drive:	Flat (~DIN 1809)
	Shank size [mm]:	55.00
	Shank type:	BMT
	Tool adaption:	ER 20 A - u-tec
	Gear ratio [i]:	1:1
	Torque max [Nm]:	25
	Rotation max [1/min]:	6000
	Rotating direction:	same
	Coolant:	IC/Ext
	Pressure max [bar]:	140
	Offset [mm]:	58

Part-#	Name	
8 050 54 021	Multispindle drilling head ER 16 AX UT IC	
	Weight [kg]:	6.110
	Notation:	offset; 180° reversible
	Version:	2-spindles
	Tool drive:	Flat (~DIN 1809)
	Shank size [mm]:	55.00
	Shank type:	BMT
	Tool adaption:	ER 16 A - u-tec
	Gear ratio [i]:	1:2
	Torque max [Nm]:	16
	Rotation max [1/min]:	12000
	Rotating direction:	same
	Coolant:	IC/Ext
	Pressure max [bar]:	25
	Offset [mm]:	56
8 050 54 036	Multispindle drilling head ER 16 AX UT IC	
	Weight [kg]:	6.040
	Notation:	offset; 180° reversible
	Version:	3-spindles
	Tool drive:	Flat (~DIN 1809)
	Shank size [mm]:	55.00
	Shank type:	BMT
	Tool adaption:	ER 16 A - u-tec
	Gear ratio [i]:	1:1
	Torque max [Nm]:	25
	Rotation max [1/min]:	6000
	Rotating direction:	same
	Coolant:	IC/Ext
	Pressure max [bar]:	140
	Please note:	2x ER 16 A offset, 1x centered, IC only in 2 x
	Offset [mm]:	56
8 050 54 037	Multispindle drilling head ER 16 AX UT	
	Weight [kg]:	6.900
	Notation:	offset; 180° reversible
	Employment for:	Main- and sub spindle
	Tool drive:	Flat (~DIN 1809)
	Shank size [mm]:	55.00
	Shank type:	BMT
	Tool adaption:	ER 16 A - u-tec
	Gear ratio [i]:	1:1
	Torque max [Nm]:	16/Sp.
	Rotation max [1/min]:	6000
	Rotating direction:	opposite
	Coolant:	no
	Please note:	stronger bearing
	Offset [mm]:	+38,1/-38,1
8 050 54 038	Multispindle drilling head ER 16 AX UT	
	Weight [kg]:	6.870
	Notation:	offset; 180° reversible
	Employment for:	Main- and sub spindle
	Tool drive:	Flat (~DIN 1809)
	Shank size [mm]:	55.00
	Shank type:	BMT
	Tool adaption:	ER 16 A - u-tec
	Gear ratio [i]:	1:1

Part-#

Name

Torque max [Nm]: 16/Sp.
 Rotation max [1/min]: 6000
 Rotating direction: opposite
 Coolant: EXT
 Please note: stronger bearing
 Offset [mm]: +38,1/-38,1

8 053 54 045

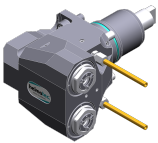
Multispindle radial head ER 16 AX UT

Weight [kg]: 6.850
 Notation: 180° reversible
 Version: 2-spindles
 Tool drive: Flat (~DIN 1809)
 Shank size [mm]: 55.00
 Shank type: BMT
 Tool adaption: ER 16 A - u-tec
 Gear ratio [i]: 1:1
 Torque max [Nm]: 32/Sp
 Rotation max [1/min]: 12000
 Rotating direction: same
 Coolant: EXT
 Center distance [mm]: 75

8 053 54 046

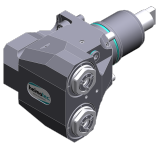

Multispindle radial head ER 16 AX UTIK

Notation: 180° reversible
 Version: 2-spindles
 Tool drive: Flat (~DIN 1809)
 Shank size [mm]: 55.00
 Shank type: BMT
 Tool adaption: ER 16 A - u-tec
 Gear ratio [i]: 1:1
 Torque max [Nm]: 32/Sp
 Rotation max [1/min]: 12000
 Rotating direction: same
 Coolant: IC/Ext
 Pressure max [bar]: 140
 Center distance [mm]: 75

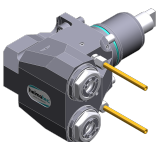
8 053 54 047

Multispindle radial head ER 20 AX UT



Notation: 180° reversible
 Version: 2-spindles
 Tool drive: Flat (~DIN 1809)
 Shank size [mm]: 55.00
 Shank type: BMT
 Tool adaption: ER 20 A - u-tec
 Gear ratio [i]: 1:1
 Torque max [Nm]: 32/Sp
 Rotation max [1/min]: 12000
 Rotating direction: same
 Coolant: EXT
 Center distance [mm]: 75

Part-#	Name	
8 053 54 048	Multispindle radial head ER 20 AX UTIK	
		<p>Notation: 180° reversible Version: 2-spindles Tool drive: Flat (~DIN 1809) Shank size [mm]: 55.00 Shank type: BMT Tool adaption: ER 20 A - u-tec Gear ratio [i]: 1:1 Torque max [Nm]: 32/Sp Rotation max [1/min]: 12000 Rotating direction: same Coolant: IC/Ext Pressure max [bar]: 140 Center distance [mm]: 75</p>
8 068 54 000	Radial whirling unit HW 46	
		<p>Notation: 180° reversible Tool drive: Flat (~DIN 1809) Shank size [mm]: 55.00 Shank type: BMT Tool adaption: HW 46 Gear ratio [i]: 1:1 Torque max [Nm]: 16 Rotation max [1/min]: 8000 Rotating direction: same Coolant: EXT Please note: without cutting inserts carrier; check applicability; Center distance [mm]: 65</p>
8 100 15 001	Tool holder radial ø17,1 / minus	
		<p>Employment for: Angle handpiece or extension CN01 Tool drive: Flat (~DIN 1809) Shank size [mm]: 55.00 Shank type: BMT Tool adaption: Interface ø17,1 / M17x1 Gear ratio [i]: 1:2 Rotation max [1/min]: 12000 Rotating direction: same Coolant: no Center distance [mm]: 77</p>
8 102 15 000	Tool holder Ø 17	
		<p>Weight [kg]: 1.930 Employment for: Angle handpiece Tool drive: Flat (~DIN 1809) Shank size [mm]: 55.00 Shank type: BMT Tool adaption: Interface 17 Gear ratio [i]: 1:1 Rotation max [1/min]: 6000 Rotating direction: same Coolant: no</p>



Part-#	Name	
8 200 03 002	Cover plate	
	Weight [kg]:	0.300
	Shank type:	BMT
8 200 10 002	Tool blank	
	Weight [kg]:	4.190
	Notation:	180° reversible
	Shank type:	BMT
	Machine adaption:	Centering key b 20
	Please note:	Housing rigid
8 202 10 006	Basic holder longitudinal seat FN 12	
	Weight [kg]:	0.960
	Notation:	180° reversible
	Shank type:	BMT
	Machine adaption:	Centering key b 20
	Tool adaption:	Interface FN 12
	Coolant:	EXT
8 209 10 000	Tool blank	
	Weight [kg]:	4.580
	Shank type:	BMT
	Machine adaption:	Centering key b 20
	Coolant:	EXT
8 209 14 002	Adapter for VDI 40	
	Weight [kg]:	2.720
	Shank type:	BMT
	Machine adaption:	Centering key b 20
	Tool adaption:	DIN 69880 - 40
	Coolant:	EXT
	Center distance [mm]:	35
8 209 14 003	Adapter for VDI 40 offset	
	Shank type:	BMT
	Machine adaption:	Centering key b 20
	Tool adaption:	DIN 69880 - 40
	Coolant:	EXT
	Center distance [mm]:	65
8 224 11 002	Turning holder sq. 20	
	Weight [kg]:	2.420
	Employment for:	right cutting tools
	Shank type:	BMT
	Machine adaption:	Centering key b 20
	Tool adaption:	Sq. 20
	Coolant:	EXT

Part-#	Name	
8 224 11 003	Cut-off holder sq. 20	
	Weight [kg]:	1.040
	Employment for:	right cutting tools
	Version:	Edge on side of turret
	Shank type:	BMT
	Machine adaption:	Centering key b 20
	Tool adaption:	Sq. 20
	Coolant:	EXT
8 224 11 005	Cut-off holder sq. 20	
	Weight [kg]:	1.100
	Employment for:	left cutting tools
	Version:	Edge on center of turret
	Shank type:	BMT
	Machine adaption:	Centering key b 20
	Tool adaption:	Sq. 20
	Coolant:	EXT
8 224 11 016	Cut-off holder sq. 3/4" R 1441	
	Weight [kg]:	1.110
	Employment for:	right cutting tools
	Version:	Edge on side of turret
	Shank type:	BMT
	Machine adaption:	Centering key b 20
	Tool adaption:	Sq. 3/4" (19,05mm)
	Coolant:	EXT
8 224 11 022	Cut-off holder sq. 20	
	Weight [kg]:	1.350
	Employment for:	right cutting tools
	Version:	Edge on side of turret
	Shank type:	BMT
	Machine adaption:	Centering key b 20
	Tool adaption:	Sq. 20
	Coolant:	EXT
8 224 12 005	Cut-off holder sq. 25	
	Weight [kg]:	1.480
	Shank type:	BMT
	Machine adaption:	Centering key b 20
	Tool adaption:	Sq. 25
	Coolant:	EXT
8 224 12 006	Cut-off holder sq. 25	
	Weight [kg]:	1.480
	Employment for:	left cutting tools
	Version:	Edge on center of turret
	Shank type:	BMT
	Machine adaption:	Centering key b 20
	Tool adaption:	Sq. 25
	Coolant:	EXT

Part-#	Name	
8 224 13 004	Cut-off holder SH 32	
	Weight [kg]:	1.000
	Employment for:	Cut-off tool 32
	Version:	Clampshaft on turret center
	Shank type:	BMT
	Machine adaption:	Centering key b 20
	Tool adaption:	Clampshaft SH 32
	Coolant:	EXT
8 224 13 007	Cut-off holder SH 32	
	Weight [kg]:	1.190
	Employment for:	Cut-off tool 32
	Version:	Clampshaft on turret side
	Shank type:	BMT
	Machine adaption:	Centering key b 20
	Tool adaption:	Clampshaft SH 32
	Coolant:	EXT
8 224 13 013	Cut-off holder SH 32	
	Weight [kg]:	1.480
	Employment for:	Cut-off tool 32
	Version:	Clampshaft on turret side
	Shank type:	BMT
	Machine adaption:	Centering key b 20
	Tool adaption:	Clampshaft SH 32
	Coolant:	EXT
	Please note:	Special
8 224 13 021	Cut-off holder SH 32 IC	
	Weight [kg]:	1.030
	Employment for:	Cut-off tool 32
	Version:	Clampshaft on turret center
	Shank type:	BMT
	Machine adaption:	Centering key b 20
	Tool adaption:	Clampshaft SH 32
	Coolant:	IC/Ext
8 224 14 000	Universal turning holder sq. 20	
	Weight [kg]:	1.730
	Notation:	180° reversible
	Shank type:	BMT
	Machine adaption:	Centering key b 20
	Tool adaption:	Sq. 20
		Sq. 20
	Coolant:	EXT
	Please note:	with spacer strip
8 224 14 016	Universal turning holder sq. 20 IC	
	Weight [kg]:	2.950
	Notation:	180° reversible
	Shank type:	BMT
	Machine adaption:	Centering key b 20
	Tool adaption:	Sq. 20
	Coolant:	IC/Ext
	Pressure max [bar]:	100
	Please note:	Key rail

Part-#	Name	
8 224 15 002	Universal turning holder sq. 25/20	
		Weight [kg]: 2.800 Notation: 180° reversible Shank type: BMT Machine adaption: Centering key b 20 Tool adaption: Sq. 25 Sq. 25 Coolant: EXT Please note: With spacer strip for sq. 20
8 224 15 012	Universal turning holder sq. 1"	
		Weight [kg]: 2.720 Shank type: BMT Machine adaption: Centering key b 20 Tool adaption: Sq. 1" (25,4mm) Sq. 1" (25,4mm) Coolant: EXT
8 224 15 046	Universal turning holder sq. 25/20	
		Weight [kg]: 5.520 Shank type: BMT Machine adaption: Centering key b 20 Tool adaption: Sq. 25 Sq. 25 Coolant: EXT Please note: Check applicability! with spacer strip for
8 224 15 062	Universal turning holder sq. 25 IC	
		Weight [kg]: 3.100 Shank type: BMT Machine adaption: Centering key b 20 Tool adaption: Sq. 25 Sq. 25 Coolant: IC/Ext Pressure max [bar]: 100 Please note: Key rail
8 224 15 063	Universal turning holder sq. 1" IC	
		Weight [kg]: 3.100 Shank type: BMT Machine adaption: Centering key b 20 Tool adaption: Sq. 1" (25,4mm) Sq. 1" (25,4mm) Coolant: IC/Ext Pressure max [bar]: 100 Please note: Key rail
8 225 11 002	Cut-off holder sq. 20 R 1432	
	Weight [kg]: 1.120 Employment for: left cutting tools Version: Edge on side of turret Shank type: BMT Machine adaption: Centering key b 20 Tool adaption: Sq. 20 Coolant: EXT	

Part-#	Name	
8 225 11 005	Cut-off holder sq. 20	
	Weight [kg]:	1.170
	Employment for:	right cutting tools
	Version:	Edge on center of turret
	Shank type:	BMT
	Machine adaption:	Centering key b 20
	Tool adaption:	Sq. 20
	Coolant:	EXT
8 225 11 009	Cut-off holder sq. 3/4" R 1442	
	Weight [kg]:	1.110
	Employment for:	left cutting tools
	Version:	Edge on side of turret
	Shank type:	BMT
	Machine adaption:	Centering key b 20
	Tool adaption:	Sq. 3/4" (19,05mm)
	Coolant:	EXT
8 225 11 012	Cut-off holder sq. 3/4"	
	Weight [kg]:	1.200
	Employment for:	right cutting tools
	Version:	Edge on center of turret
	Shank type:	BMT
	Machine adaption:	Centering key b 20
	Tool adaption:	Sq. 3/4" (19,05mm)
	Coolant:	EXT
8 229 16 001	Tool holder C 4 IC	
	Weight [kg]:	2.400
	Notation:	180° reversible
	Version:	right
	Shank type:	BMT
	Machine adaption:	Centering key b 20
	Tool adaption:	heimatec Capto(TM) C 4
	Coolant:	IC/Ext
	Please note:	Check applicability; note tool length!
	Offset [mm]:	12
8 229 16 003	Tool holder C 4 IC	
	Weight [kg]:	3.330
	Notation:	180° reversible
	Version:	right
	Shank type:	BMT
	Machine adaption:	Centering key b 20
	Tool adaption:	heimatec Capto(TM) C 4
	Coolant:	IC/Ext
	Please note:	Check applicability; note tool length!
	Offset [mm]:	55
8 229 16 008	Tool holder C 4 IC	
	Weight [kg]:	3.430
	Notation:	180° reversible
	Version:	right
	Shank type:	BMT
	Machine adaption:	Centering key b 20
	Tool adaption:	heimatec Capto(TM) C 4
	Coolant:	IC
	Please note:	Check applicability; note tool length!



Part-#	Name	
	Offset [mm]:	55
8 229 16 009	Tool holder C 4 IC	
	Weight [kg]:	2.410
	Notation:	180° reversible
	Version:	right
	Shank type:	BMT
	Machine adaption:	Centering key b 20
	Tool adaption:	heimatec Capto(TM) C 4
	Coolant:	IC
	Please note:	Check applicability; note tool length!
	Offset [mm]:	12
8 229 16 011	Tool holder C 4 IC	
	Weight [kg]:	3.440
	Notation:	180° reversible
	Version:	left
	Shank type:	BMT
	Machine adaption:	Centering key b 20
	Tool adaption:	heimatec Capto(TM) C 4
	Coolant:	IC
	Please note:	Check applicability; note tool length!
	Offset [mm]:	55
8 229 17 003	Tool holder C 5 IC	
	Notation:	180° reversible
	Version:	right
	Shank type:	BMT
	Machine adaption:	Centering key b 20
	Tool adaption:	heimatec Capto(TM) C 5
	Coolant:	IC
	Please note:	Check applicability; note tool length!
	Offset [mm]:	64
8 240 14 017	Boring bar holder Ø 12 - slotted	
	Weight [kg]:	2.900
	Notation:	180° reversible
	Version:	slotted
	Shank type:	BMT
	Machine adaption:	Centering key b 20
	Tool adaption:	Ø 12
	Coolant:	EXT
	Pressure max [bar]:	100
	Center distance [mm]:	75
8 240 14 022	Boring bar holder Ø 10 - slotted	
	Weight [kg]:	2.900
	Notation:	180° reversible
	Version:	slotted
	Shank type:	BMT
	Machine adaption:	Centering key b 20
	Tool adaption:	Ø 10
	Coolant:	EXT
	Pressure max [bar]:	100
	Center distance [mm]:	75

Part-#	Name		
	8 240 15 003	Boring bar holder Ø 16 DIN 1835 E	
		Weight [kg]:	3.020
		Shank type:	BMT
		Machine adaption:	Centering key b 20
		Tool adaption:	Whistle-Notch (DIN 1835 E) 16
		Coolant:	IC/Ext
		Center distance [mm]:	75
	8 240 15 004	Tool holder C 3 IC	
		Weight [kg]:	3.580
		Notation:	180° reversible; offset
		Shank type:	BMT
		Machine adaption:	Centering key b 20
		Tool adaption:	heimatec Capto(TM) C 3
		Coolant:	IC
	Center distance [mm]:	75	
	8 240 15 006	Collet chuck holder ER 25	
		Weight [kg]:	3.520
		Notation:	180° reversible
		Shank type:	BMT
		Machine adaption:	Centering key b 20
		Tool adaption:	ER 25
		Coolant:	IC/Ext
	Please note:	Insert reversible	
	Center distance [mm]:	75	
	8 240 15 007	Insert drill holder 16 IC	
		Weight [kg]:	4.540
		Notation:	180° reversible
		Shank type:	BMT
		Tool adaption:	Whistle-Notch (DIN 1835 E) 16
		Coolant:	IC
		Center distance [mm]:	75
	8 240 15 019	Collet chuck holder ER 25 AX UT IC	
		Weight [kg]:	3.380
		Notation:	180° reversible; offset
		Shank type:	BMT
		Machine adaption:	Centering key b 20
		Tool adaption:	ER 25 A - u-tec
		Coolant:	IC/Ext
	Center distance [mm]:	75	
	8 240 15 039	Boring bar holder Ø 16 - slotted	
		Weight [kg]:	3.000
		Notation:	180° reversible
		Shank type:	BMT
		Machine adaption:	Centering key b 20
		Tool adaption:	Ø 16
		Coolant:	EXT
	Center distance [mm]:	75	

Part-#	Name	
8 240 16 001	Boring bar holder Ø 20 DIN 1835 E	
	Weight [kg]:	2.960
	Shank type:	BMT
	Machine adaption:	Centering key b 20
	Tool adaption:	Whistle-Notch (DIN 1835 E) 20
	Coolant:	IC
	Center distance [mm]:	75
8 240 16 004	Tool holder HT 4 IC	
	Weight [kg]:	2.890
	Notation:	180° reversible; offset
	Shank type:	BMT
	Machine adaption:	Centering key b 20
	Tool adaption:	HT 4
	Coolant:	IC/Ext
	Center distance [mm]:	75
8 240 16 005	Boring bar holder Ø 24	
	Notation:	180° reversible
	Version:	Special
	Shank type:	BMT
	Machine adaption:	Centering key b 20
	Tool adaption:	Ø 24
	Coolant:	IC/Ext
	Please note:	Housing rigid
	Center distance [mm]:	75
8 240 16 006	Tool holder HT 4 IC	
	Weight [kg]:	3.340
	Notation:	offset
	Version:	Special
	Shank type:	BMT
	Machine adaption:	Centering key b 20
	Tool adaption:	HT 4
	Coolant:	IC/Ext
	Center distance [mm]:	75
8 240 16 008	Collet chuck holder ER 32	
	Weight [kg]:	3.200
	Notation:	180° reversible
	Shank type:	BMT
	Machine adaption:	Centering key b 20
	Tool adaption:	ER 32
	Coolant:	IC/Ext
	Please note:	Insert reversible
	Center distance [mm]:	75
8 240 16 009	Insert drill holder 20 IC	
	Weight [kg]:	4.480
	Notation:	180° reversible
	Shank type:	BMT
	Tool adaption:	Whistle-Notch (DIN 1835 E) 20
	Coolant:	IC
	Center distance [mm]:	75



Nakamura
AS-200L - 12 Stationen

Part-#	Name	
8 240 16 020	Tool holder HT 4 IC	
	Weight [kg]:	5.900
	Notation:	offset; 180° reversible
	Version:	Special
	Shank type:	BMT
	Machine adaption:	Centering key b 20
	Tool adaption:	HT 4
	Coolant:	IC/Ext
	Center distance [mm]:	75
8 240 16 030	Boring bar holder Ø 20	
	Weight [kg]:	3.940
	Notation:	180° reversible
	Shank type:	BMT
	Machine adaption:	Centering key b 20
	Tool adaption:	Ø 20
	Coolant:	IC/Ext
	Please note:	Housing rigid
	Center distance [mm]:	75
8 240 16 034	Collet chuck holder ER 32	
	Weight [kg]:	3.060
	Notation:	180° reversible; offset
	Shank type:	BMT
	Machine adaption:	Centering key b 20
	Tool adaption:	ER 32
	Coolant:	IC/Ext
	Center distance [mm]:	75
8 240 16 040	Tool holder C 4 IC	
	Weight [kg]:	3.130
	Notation:	180° reversible
	Version:	offset; right
	Shank type:	BMT
	Machine adaption:	Centering key b 20
	Tool adaption:	heimatec Capto(TM) C 4
	Coolant:	IC/Ext
	Please note:	Check applicability; note tool length!
	Center distance [mm]:	75
8 240 16 045	Tool holder C 4 IC	
	Weight [kg]:	2.960
	Notation:	180° reversible
	Version:	offset; right
	Shank type:	BMT
	Machine adaption:	Centering key b 20
	Tool adaption:	heimatec Capto(TM) C 4
	Coolant:	IC
	Please note:	Check applicability; note tool length!
	Center distance [mm]:	75

Part-#	Name	
8 240 16 046	Tool holder C 4 IC	
	Weight [kg]:	3.480
	Notation:	180° reversible
	Version:	right
	Shank type:	BMT
	Machine adaption:	Centering key b 20
	Tool adaption:	heimatec Capto(TM) C 4
	Coolant:	IC
	Please note:	Check applicability; note tool length!
	Center distance [mm]:	75
8 240 16 051	Tool holder C 4 IC	
	Weight [kg]:	3.430
	Notation:	180° reversible
	Version:	left
	Shank type:	BMT
	Machine adaption:	Centering key b 20
	Tool adaption:	heimatec Capto(TM) C 4
	Coolant:	IC
	Please note:	Check applicability; note tool length!
	Center distance [mm]:	75
8 240 16 054	Tool holder C 4 IC	
	Weight [kg]:	2.840
	Notation:	180° reversible
	Version:	left; special
	Shank type:	BMT
	Machine adaption:	Centering key b 20
	Tool adaption:	heimatec Capto(TM) C 4
	Coolant:	IC/Ext
	Please note:	Check applicability; note tool length!
	Center distance [mm]:	40
8 240 16 077	Boring bar holder Ø 20 - slotted	
	Weight [kg]:	3.120
	Notation:	180° reversible
	Version:	slotted
	Shank type:	BMT
	Machine adaption:	Centering key b 20
	Tool adaption:	Ø 20
	Coolant:	EXT
	Pressure max [bar]:	100
	Center distance [mm]:	75
8 240 17 005	Boring bar holder Ø 25	
	Weight [kg]:	3.820
	Notation:	180° reversible
	Shank type:	BMT
	Machine adaption:	Centering key b 20
	Tool adaption:	Ø 25
	Coolant:	IC/Ext
	Please note:	Housing rigid
	Center distance [mm]:	75

Part-#	Name	
8 240 17 007	Boring bar holder Ø 25	
	Weight [kg]:	2.320
	Notation:	180° reversible
	Version:	offset
	Shank type:	BMT
	Machine adaption:	Centering key b 20
	Tool adaption:	Ø 25
	Coolant:	IC/Ext
	Please note:	Housing rigid
	Center distance [mm]:	75
8 240 17 008	Boring bar holder Ø 25 DIN 1835 E	
	Weight [kg]:	3.210
	Notation:	offset; 180° reversible
	Version:	Special
	Shank type:	BMT
	Machine adaption:	Centering key b 20
	Tool adaption:	Whistle-Notch (DIN 1835 E) 25
	Coolant:	IC/Ext
	Center distance [mm]:	75
8 240 17 011	Boring bar holder Ø 25,4 (1")	
	Weight [kg]:	3.800
	Notation:	180° reversible
	Shank type:	BMT
	Machine adaption:	Centering key b 20
	Tool adaption:	Ø 1" (25,4mm)
	Coolant:	IC/Ext
	Pressure max [bar]:	140
	Please note:	Housing rigid
	Center distance [mm]:	75
8 240 17 016	Boring bar holder Ø 30	
	Notation:	180° reversible
	Version:	Special
	Shank type:	BMT
	Machine adaption:	Centering key b 20
	Tool adaption:	Ø 30
	Coolant:	IC/Ext
	Please note:	Housing rigid
	Center distance [mm]:	75
8 240 17 021	Collet chuck holder ER 40	
	Weight [kg]:	3.710
	Notation:	180° reversible
	Shank type:	BMT
	Machine adaption:	Centering key b 20
	Tool adaption:	ER 40
	Coolant:	IC/Ext
	Please note:	Insert reversible
	Center distance [mm]:	75



Part-#	Name	
8 240 17 023	Insert drill holder 25 IC	
	Weight [kg]:	4.380
	Notation:	180° reversible
	Shank type:	BMT
	Tool adaption:	Whistle-Notch (DIN 1835 E) 25
	Coolant:	IC
	Center distance [mm]:	75
8 240 17 031	Boring bar holder Ø 30	
	Notation:	180° reversible
	Version:	Special
	Shank type:	BMT
	Machine adaption:	Centering key b 20
	Tool adaption:	Ø 30
	Coolant:	EXT
	Center distance [mm]:	112
8 240 17 032	Boring bar holder Ø 30	
	Notation:	180° reversible
	Version:	Special
	Shank type:	BMT
	Machine adaption:	Centering key b 20
	Tool adaption:	Ø 30
	Coolant:	EXT
	Center distance [mm]:	105
8 240 17 049	Boring bar holder Ø 1" offset	
	Weight [kg]:	2.450
	Notation:	180° reversible
	Version:	offset
	Shank type:	BMT
	Machine adaption:	Centering key b 20
	Tool adaption:	Ø 1" (25,4mm)
	Coolant:	IC/Ext
	Please note:	Housing rigid
	Center distance [mm]:	75
8 240 17 052	Boring bar holder Ø 25	
	Weight [kg]:	4.430
	Employment for:	Main spindle
	Version:	long; special
	Shank type:	BMT
	Machine adaption:	Centering key b 20
	Tool adaption:	Ø 25
	Coolant:	IC/Ext
	Center distance [mm]:	75
8 240 17 061	Boring bar holder Ø 1"	
	Weight [kg]:	2.300
	Shank type:	BMT
	Machine adaption:	Centering key b 20
	Tool adaption:	Ø 1" (25,4mm)
	Coolant:	IC/Ext
	Center distance [mm]:	55

Part-#	Name	
8 240 17 065	Boring bar holder Ø 25 - slotted	
	Weight [kg]:	3.670
	Notation:	180° reversible
	Shank type:	BMT
	Machine adaption:	Centering key b 20
	Tool adaption:	Ø 25
	Coolant:	EXT
	Please note:	Housing rigid
	Center distance [mm]:	75
8 240 17 078	Boring bar holder Ø 1 1/4" - slotted	
	Weight [kg]:	3.440
	Notation:	180° reversible
	Shank type:	BMT
	Machine adaption:	Centering key b 20
	Tool adaption:	Ø 1 1/4" (31,75mm)
	Coolant:	EXT
	Please note:	Housing rigid
	Center distance [mm]:	75
8 240 17 096	Tool holder C 5 IC	
	Weight [kg]:	5.030
	Notation:	180° reversible
	Version:	right
	Shank type:	BMT
	Machine adaption:	Centering key b 20
	Tool adaption:	heimatec Capto(TM) C 5
	Coolant:	IC
	Please note:	Check applicability; note tool length!
	Center distance [mm]:	75
8 240 17 106	Boring bar holder Ø 25	
	Weight [kg]:	4.800
	Notation:	180° reversible
	Shank type:	BMT
	Machine adaption:	Centering key b 20
	Tool adaption:	Ø 25
	Coolant:	IC/Ext
	Please note:	Check applicability! housing rigid
	Center distance [mm]:	95
8 240 17 114	Boring bar holder Ø 1"	
	Weight [kg]:	4.760
	Notation:	180° reversible
	Shank type:	BMT
	Machine adaption:	Centering key b 20
	Tool adaption:	Ø 1" (25,4mm)
	Coolant:	IC/Ext
	Please note:	Check applicability! housing rigid
	Center distance [mm]:	95



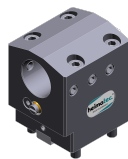

Part-#	Name	
8 240 17 115	Boring bar holder Ø 1 1/4"	
	Weight [kg]:	4.620
	Notation:	180° reversible
	Shank type:	BMT
	Machine adaption:	Centering key b 20
	Tool adaption:	Ø 1 1/4" (31,75mm)
	Coolant:	IC/Ext
	Please note:	Check applicability! housing rigid
	Center distance [mm]:	95
8 240 17 116	Boring bar holder Ø 1 1/4"	
	Weight [kg]:	2.440
	Notation:	180° reversible
	Shank type:	BMT
	Machine adaption:	Centering key b 20
	Tool adaption:	Ø 1 1/4" (31,75mm)
	Coolant:	IC/Ext
	Please note:	Housing rigid
	Center distance [mm]:	75
8 240 18 010	Boring bar holder Ø 32	
	Weight [kg]:	3.640
	Notation:	180° reversible
	Shank type:	BMT
	Machine adaption:	Centering key b 20
	Tool adaption:	Ø 32
	Coolant:	IC/Ext
	Pressure max [bar]:	140
	Please note:	Housing rigid
	Center distance [mm]:	75
8 240 18 011	Boring bar holder Ø 32	
	Weight [kg]:	2.680
	Shank type:	BMT
	Machine adaption:	Centering key b 20
	Tool adaption:	Ø 32
	Coolant:	IC/Ext
	Center distance [mm]:	55
8 240 18 012	Boring bar holder Ø 32 offset	
	Weight [kg]:	2.420
	Notation:	180° reversible
	Version:	offset
	Shank type:	BMT
	Machine adaption:	Centering key b 20
	Tool adaption:	Ø 32
	Coolant:	IC/Ext
	Please note:	Housing rigid
	Center distance [mm]:	75

Nakamura
AS-200L - 12 Stationen

Part-#	Name	
8 240 18 016	Boring bar holder Ø 32	
	Weight [kg]:	4.370
	Notation:	180° reversible
	Shank type:	BMT
	Machine adaption:	Centering key b 20
	Tool adaption:	Ø 32
	Coolant:	IC/Ext
	Please note:	Housing rigid
	Center distance [mm]:	90
8 240 18 021	Insert drill holder 32 IC	
	Weight [kg]:	4.200
	Notation:	180° reversible
	Shank type:	BMT
	Tool adaption:	Whistle-Notch (DIN 1835 E) 32
	Coolant:	IC
	Center distance [mm]:	75
8 240 18 033	Boring bar holder Ø 1 1/4"	
	Weight [kg]:	3.630
	Notation:	180° reversible
	Shank type:	BMT
	Machine adaption:	Centering key b 20
	Tool adaption:	Ø 1 1/4" (31,75mm)
	Coolant:	IC/Ext
	Please note:	Housing rigid
	Center distance [mm]:	75
8 240 18 037	Boring bar holder Ø 1 1/2"	
	Weight [kg]:	4.540
	Notation:	180° reversible
	Shank type:	BMT
	Machine adaption:	Centering key b 20
	Tool adaption:	Ø 1 1/2" (38,1mm)
	Coolant:	IC/Ext
	Center distance [mm]:	75
8 240 18 045	Boring bar holder Ø 32 offset	
	Weight [kg]:	4.380
	Notation:	offset
	Shank type:	BMT
	Machine adaption:	Centering key b 20
	Tool adaption:	Ø 32
	Coolant:	IC/Ext
	Please note:	Front edge ø32- adapter on turret center
	Center distance [mm]:	75
8 240 18 085	Boring bar holder Ø 32	
	Weight [kg]:	4.605
	Notation:	180° reversible
	Shank type:	BMT
	Machine adaption:	Centering key b 20
	Tool adaption:	Ø 32
	Coolant:	IC/Ext
	Please note:	Check applicability! housing rigid
	Center distance [mm]:	95

Part-#	Name	
8 240 18 088	Boring bar holder Ø 32 offset	
	Weight [kg]:	4.200
	Notation:	offset
	Shank type:	BMT
	Machine adaption:	Centering key b 20
	Tool adaption:	Ø 32
	Coolant:	IC/Ext
	Please note:	Front edge ø32- adapter 20mm from turret center offset
	Center distance [mm]:	75
8 240 18 098	Boring bar holder Ø 1 1/4"	
	Notation:	180° reversible
	Shank type:	BMT
	Machine adaption:	Centering key b 20
	Tool adaption:	Ø 1 1/4" (31,75mm)
	Coolant:	IC/Ext
	Please note:	Check applicability!
	Center distance [mm]:	100
8 240 18 102	Boring bar holder Ø 32 offset	
	Weight [kg]:	6.780
	Notation:	180° reversible
	Version:	offset
	Shank type:	BMT
	Machine adaption:	Centering key b 20
	Tool adaption:	Ø 32
	Coolant:	IC
	Pressure max [bar]:	100
	Please note:	Check applicability! length
	Center distance [mm]:	80
8 240 19 007	Boring bar holder Ø 40	
	Weight [kg]:	4.260
	Notation:	offset; 180° reversible
	Shank type:	BMT
	Machine adaption:	Centering key b 20
	Tool adaption:	Ø 40
	Coolant:	IC/Ext
	Center distance [mm]:	75
8 240 19 009	Boring bar holder Ø 40	
	Weight [kg]:	4.480
	Notation:	180° reversible
	Shank type:	BMT
	Machine adaption:	Centering key b 20
	Tool adaption:	Ø 40
	Coolant:	IC/Ext
	Center distance [mm]:	75
8 240 19 012	Boring bar holder Ø 40	
	Weight [kg]:	3.460
	Shank type:	BMT
	Machine adaption:	Centering key b 20
	Tool adaption:	Ø 40
	Coolant:	IC/Ext
	Please note:	Special version

Nakamura
AS-200L - 12 Stationen

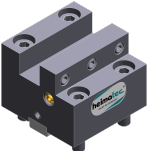
Part-#	Name	
	Center distance [mm]:	75
8 240 19 025	Insert drill holder 40 IC	
	Weight [kg]:	4.740
	Notation:	180° reversible
	Shank type:	BMT
	Tool adaption:	Whistle-Notch (DIN 1835 E) 40
	Coolant:	IC
	Center distance [mm]:	75
8 240 19 105	Boring bar holder Ø 40	
	Weight [kg]:	2.400
	Notation:	180° reversible
	Shank type:	BMT
	Machine adaption:	Centering key b 20
	Tool adaption:	Ø 40
	Coolant:	IC/Ext
	Center distance [mm]:	35
8 240 19 139	Boring bar holder Ø 40	
	Weight [kg]:	4.760
	Notation:	180° reversible
	Shank type:	BMT
	Machine adaption:	Centering key b 20
	Tool adaption:	Ø 40
	Coolant:	IC
	Please note:	Check applicability!
	Center distance [mm]:	100
8 240 19 142	Boring bar holder Ø 40 offset	
	Weight [kg]:	5.000
	Notation:	offset
	Shank type:	BMT
	Machine adaption:	Centering key b 20
	Tool adaption:	Ø 40
	Coolant:	IC/Ext
	Please note:	Front edge Ø40- adapter 60mm from turret center offset
	Center distance [mm]:	75
8 240 19 143	Boring bar holder Ø 40 offset	
	Weight [kg]:	4.000
	Notation:	offset
	Shank type:	BMT
	Machine adaption:	Centering key b 20
	Tool adaption:	Ø 40
	Coolant:	IC/Ext
	Please note:	Front edge Ø40- adapter 20mm from turret center offset
	Center distance [mm]:	75
8 244 11 002	Facing holder sq. 20	
	Weight [kg]:	2.340
	Notation:	180° reversible
	Shank type:	BMT
	Machine adaption:	Centering key b 20
	Tool adaption:	Sq. 20
	Coolant:	EXT



Nakamura

AS-200L - 12 Stationen

Part-#	Name	
8 244 11 009	Facing holder sq. 20	
	Weight [kg]:	4.090
	Notation:	180° reversible
	Version:	Special; extended version
	Shank type:	BMT
	Machine adaption:	Centering key b 20
	Tool adaption:	Sq. 20
	Coolant:	EXT
8 244 12 005	Facing holder sq. 1"	
	Weight [kg]:	3.570
	Shank type:	BMT
	Machine adaption:	Centering key b 20
	Tool adaption:	Sq. 1" (25,4mm)
	Coolant:	EXT
8 244 12 027	Facing holder sq. 25 IC	
	Weight [kg]:	3.640
	Shank type:	BMT
	Machine adaption:	Centering key b 20
	Tool adaption:	Sq. 25
	Coolant:	IC/Ext
	Pressure max [bar]:	100
8 249 15 001	Double collet chuck holder ER 25	
	Weight [kg]:	4.240
	Notation:	180° reversible
	Shank type:	BMT
	Machine adaption:	Centering key b 20
	Tool adaption:	ER 25
	Coolant:	IC/Ext
	Center distance [mm]:	75
8 249 15 013	Double tool holder C 3 IC	
	Weight [kg]:	4.210
	Notation:	180° reversible
	Employment for:	Main- and sub spindle
	Version:	offset; right
	Shank type:	BMT
	Machine adaption:	Centering key b 20
	Tool adaption:	heimatec Capto(TM) C 3
		heimatec Capto(TM) C 3
	Coolant:	IC
	Please note:	Check applicability; note tool length!
	Center distance [mm]:	82,5
8 249 16 000	Double collet chuck holder ER 32	
	Weight [kg]:	4.000
	Notation:	180° reversible
	Shank type:	BMT
	Machine adaption:	Centering key b 20
	Tool adaption:	ER 32
	Coolant:	IC/Ext
	Center distance [mm]:	75



Nakamura
AS-200L - 12 Stationen

Part-#	Name	
8 250 16 005	Multiple tool holder C 4 IC	
	Weight [kg]:	4.620
	Employment for:	Main- and sub spindle
	Version:	right
	Shank type:	BMT
	Machine adaption:	Centering key b 20
	Tool adaption:	heimatec Capto(TM) C 4
	Coolant:	IC
	Please note:	Check applicability; note tool length!
	Offset [mm]:	±55
8 250 16 007	Double tool holder C 4 IC	
	Weight [kg]:	4.630
	Notation:	180° reversible
	Employment for:	Main- and sub spindle
	Version:	left
	Shank type:	BMT
	Machine adaption:	Centering key b 20
	Tool adaption:	heimatec Capto(TM) C 4
	Coolant:	IC
	Please note:	Check applicability; note tool length!
	Offset [mm]:	±55
8 251 12 006	Double turning holder sq. 25	
	Weight [kg]:	4.910
	Notation:	180° reversible
	Employment for:	right cutting tools
	Shank type:	BMT
	Machine adaption:	Centering key b 20
	Tool adaption:	Sq. 25
	Coolant:	EXT
8 251 13 007	Combi multiple holder 6x sq. 3/4" IC	
	Weight [kg]:	5.600
	Employment for:	Main- and sub spindle
	Shank type:	BMT
	Machine adaption:	Centering key b 20
	Tool adaption:	Sq. 3/4" (19,05mm)
		Sq. 3/4" (19,05mm)
		Sq. 3/4" (19,05mm)
		Sq. 3/4" (19,05mm)
	Coolant:	IC/Ext
	Pressure max [bar]:	100
	Please note:	Key rail
8 251 13 008	Combi multiple holder 3x sq. 3/4" IC	
	Shank type:	BMT
	Machine adaption:	Centering key b 20
	Tool adaption:	Sq. 3/4" (19,05mm)
		Sq. 3/4" (19,05mm)
	Coolant:	IC/Ext
	Pressure max [bar]:	100
	Please note:	Key rail



Part-#	Name	
8 251 14 027	Combi multiple holder 6x sq. 3/4"	
	Weight [kg]:	5.900
	Shank type:	BMT
	Machine adaption:	Centering key b 20
	Tool adaption:	Sq. 3/4"
		Sq. 3/4"
		Sq. 3/4"
		Sq. 3/4"
	Coolant:	EXT
	Pressure max [bar]:	80
8 251 14 078	Combi multiple holder 6x sq. 20 IC	
	Weight [kg]:	5.620
	Employment for:	Main- and sub spindle
	Shank type:	BMT
	Machine adaption:	Centering key b 20
	Tool adaption:	Sq. 20
		Sq. 20
		Sq. 20
		Sq. 20
		Sq. 20
	Coolant:	IC/Ext
	Pressure max [bar]:	100
	Please note:	Key rail
8 251 14 079	Combi multiple holder 3x sq. 20 IC	
	Weight [kg]:	3.650
	Shank type:	BMT
	Machine adaption:	Centering key b 20
	Tool adaption:	Sq. 20
		Sq. 20
		Sq. 20
	Coolant:	IC/Ext
	Pressure max [bar]:	100
	Please note:	Key rail
8 251 15 048	Combi double turning holder sq. 25 IC	
	Notation:	180° reversible
	Employment for:	Main- and sub spindle
	Shank type:	BMT
	Machine adaption:	Centering key b 20
	Tool adaption:	Sq. 25
		Sq. 25
		Sq. 25
		Sq. 25
		Sq. 25
	Coolant:	IC/Ext
	Pressure max [bar]:	100
	Please note:	Key rail
8 251 16 013	Multiple tool holder C 4 IC	
	Weight [kg]:	6.400
	Employment for:	Main- and sub spindle
	Version:	right
	Shank type:	BMT
	Machine adaption:	Centering key b 20
	Tool adaption:	heimatec Capto(TM) C 4
		heimatec Capto(TM) C 4
	Coolant:	IC
	Please note:	Check applicability; note tool length!

Nakamura
AS-200L - 12 Stationen

Part-#	Name	
	Offset [mm]:	±64
8 253 16 010	Multiple tool holder C 4 IC	
	Weight [kg]:	6.240
	Version:	right
	Shank type:	BMT
	Machine adaption:	Centering key b 20
	Tool adaption:	heimatec Capto(TM) C 4 heimatec Capto(TM) C 4 - 15°
	Coolant:	IC/Ext
	Please note:	Check applicability; note tool length!
	Center distance [mm]:	75
8 253 16 011	Multiple tool holder C 4 IC	
	Weight [kg]:	5.480
	Employment for:	Main spindle
	Version:	offset; right
	Shank type:	BMT
	Machine adaption:	Centering key b 20
	Tool adaption:	heimatec Capto(TM) C 4 heimatec Capto(TM) C 4 - 15°
	Coolant:	IC/Ext
	Please note:	Check applicability; note tool length!
	Center distance [mm]:	75
8 253 16 014	Multiple tool holder C 4 IC	
	Version:	offset; right
	Shank type:	BMT
	Machine adaption:	Centering key b 20
	Tool adaption:	heimatec Capto(TM) C 4 heimatec Capto(TM) C 4 - 15°
	Coolant:	IC
	Please note:	Check applicability; note tool length!
	Center distance [mm]:	75
8 253 16 018	Multiple tool holder C 4 IC	
	Version:	right
	Shank type:	BMT
	Machine adaption:	Centering key b 20
	Tool adaption:	heimatec Capto(TM) C 4 heimatec Capto(TM) C 4 - 15°
	Coolant:	IC
	Please note:	Check applicability; note tool length!
	Center distance [mm]:	75
8 253 16 025	Multiple tool holder C 4 IC	
	Weight [kg]:	6.320
	Version:	right
	Shank type:	BMT
	Machine adaption:	Centering key b 20
	Tool adaption:	heimatec Capto(TM) C 4 heimatec Capto(TM) C 4 - 15°
	Coolant:	IC
	Please note:	Check applicability; note tool length!
	Center distance [mm]:	75

Part-#	Name	
8 253 16 026	Multiple tool holder C 4 IC	
	Weight [kg]:	0.100
	Version:	offset; right
	Shank type:	BMT
	Machine adaption:	Centering key b 20
	Tool adaption:	heimatec Capto(TM) C 4 heimatec Capto(TM) C 4 - 15°
	Coolant:	IC
	Please note:	Check applicability; note tool length!
	Center distance [mm]:	75
8 253 16 036	Multiple boring bar holder 3x Ø 20	
	Weight [kg]:	7.040
	Employment for:	Main- and sub spindle
	Shank type:	BMT
	Machine adaption:	Centering key b 20
	Tool adaption:	Ø 20 Ø 20
	Coolant:	IC/Ext
	Center distance [mm]:	55/95
8 253 17 013	Multiple boring bar holder Ø 25	
	Weight [kg]:	2.520
	Notation:	180° reversible
	Shank type:	BMT
	Machine adaption:	Centering key b 20
	Tool adaption:	Ø 25
	Coolant:	IC/Ext
	Center distance [mm]:	39/75
8 253 17 064	Multiple boring bar holder 2x Ø 25	
	Weight [kg]:	5.140
	Employment for:	Main- and sub spindle
	Shank type:	BMT
	Machine adaption:	Centering key b 20
	Tool adaption:	Ø 25 Ø 25 - 15°
	Coolant:	IC/Ext
	Center distance [mm]:	75
8 253 17 066	Double boring bar holder Ø 1"	
	Weight [kg]:	2.500
	Shank type:	BMT
	Machine adaption:	Centering key b 20
	Tool adaption:	Ø 1" (25,4mm)
	Coolant:	IC/Ext
	Center distance [mm]:	39/75
8 253 17 067	Multiple boring bar holder 2x Ø 1"	
	Weight [kg]:	5.120
	Employment for:	Main- and sub spindle
	Shank type:	BMT
	Machine adaption:	Centering key b 20
	Tool adaption:	Ø 1" (25,4mm) Ø 1" (25,4mm) - 15°
	Coolant:	IC/Ext
	Center distance [mm]:	75

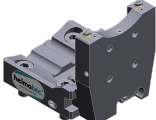
Part-#	Name	
8 253 17 086	Multiple boring bar holder 3x Ø 1"	
	Weight [kg]:	6.470
	Employment for:	Main- and sub spindle
	Shank type:	BMT
	Machine adaption:	Centering key b 20
	Tool adaption:	Ø 1" Ø 1"
	Coolant:	IC/Ext
	Center distance [mm]:	55/95
8 259 12 010	Multiple turning holder 2x sq. 20	
	Weight [kg]:	2.890
	Notation:	180° reversible
	Version:	Y-axes offset
	Shank type:	BMT
	Machine adaption:	Centering key b 20
	Tool adaption:	Sq. 20 Sq. 20
	Coolant:	EXT
8 262 19 001	Stock stop Ø 60 offset	
	Weight [kg]:	3.440
	Notation:	rotating
	Shank type:	BMT
	Machine adaption:	Centering key b 20
	Coolant:	no
	Please note:	Lenght adjustable
	Center distance [mm]:	75
8 263 19 002	Tool holder with rotating centering point	
	Weight [kg]:	4.280
	Notation:	180° reversible
	Shank type:	BMT
	Machine adaption:	Centering key b 20
	Rotation max [1/min]:	6000
	Coolant:	EXT
	Please note:	Taper roller bearings
	Center distance [mm]:	75
8 320 12 010	Cut-off holder, height adjustable SH 26 IC	
	Weight [kg]:	1.680
	Notation:	180° reversible
	Shank type:	BMT
	Machine adaption:	Centering key b 20
	Tool adaption:	Clampshaft SH 26
	Coolant:	IC/Ext
	Pressure max [bar]:	70
8 320 12 020	Cut-off holder, height adjustable SH 26 IC	
	Notation:	180° reversible
	Shank type:	BMT
	Machine adaption:	Centering key b 20
	Tool adaption:	Clampshaft SH 26
	Coolant:	IC/Ext
	Pressure max [bar]:	70
	Please note:	with offset cut-off tool holder

Part-#	Name	
8 320 13 002	Cut-off holder, height adjustable SH 32 IC	
	Weight [kg]:	1.570
	Notation:	180° reversible
	Shank type:	BMT
	Machine adaption:	Centering key b 20
	Tool adaption:	Clampshaft SH 32
	Coolant:	IC/Ext
	Pressure max [bar]:	70
8 320 13 010	Cut-off holder, height adjustable SH 32 IC	
	Weight [kg]:	1.730
	Notation:	180° reversible
	Shank type:	BMT
	Machine adaption:	Centering key b 20
	Tool adaption:	Clampshaft SH 32
	Coolant:	IC/Ext
	Pressure max [bar]:	70
	Please note:	Clampshaft internal
8 320 13 015	Cut-off holder, height adjustable SH 32 IC	
	Weight [kg]:	1.830
	Notation:	180° reversible
	Shank type:	BMT
	Machine adaption:	Centering key b 20
	Tool adaption:	Clampshaft SH 32
	Coolant:	IC/Ext
	Pressure max [bar]:	70
	Please note:	with offset cut-off tool holder

heimatec.u-tec®

heimatec.com

Products / Tool change systems /
u-tec® Tool-changing system



versions see catalog

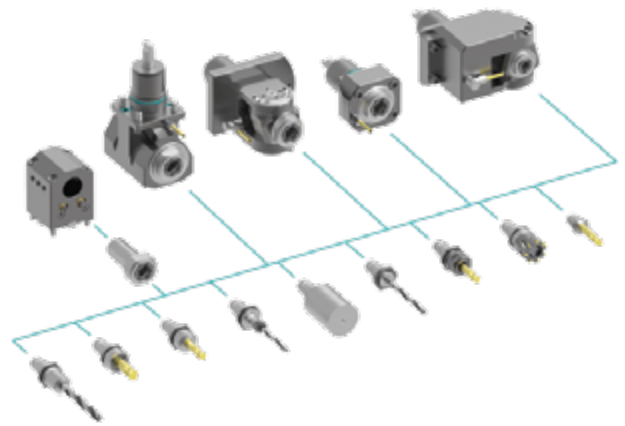

heimatec.easy-quick

heimatec.com

Products / Tool change systems /
easy-quick HT quick-changing system



versions see catalog

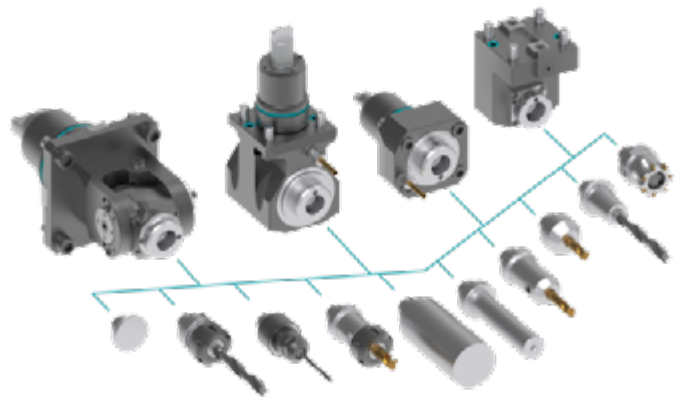

heimatec.Capto™

heimatec.com

Products / Tool change systems /
heimatec.Capto™ quick-changing system



versions see catalog

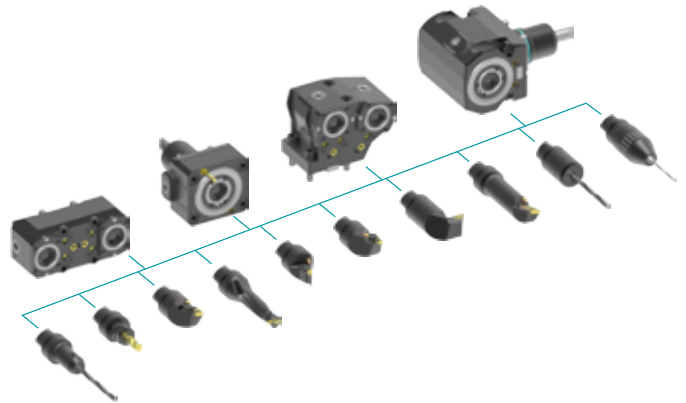

heimatec.accessories

heimatec.com

Products / Accessories



versions see catalog





● heimatec overseas branches

○ global representations of heimatec

heimatec[®]

heimatec GmbH
Präzisionswerkzeuge
Carl-Benz-Str. 4
77871 Renchen
Germany

T +49 7843 9466 0
www.heimatec.com
info@heimatec.com

Please find the contact details of our worldwide trading partners on our website:
<https://heimatec.com/business-partners>