

Nakamura
JX-250 Ø65/75
Std. Revolver
rechts



High-tech from heimatec - heimatec - Tools and systems for productive turning and milling

heimatec belongs to the international technology and quality leaders for precision tools and specializes in the development and production of high-precision static and live tools for all CNC lathes, CNC turn-/mill machines and CNC machining centers.

The range of products* spans from static BMT and VDI tool holders, live tools up to highly complex customer-specific individual solutions. heimatec, headquartered in Renchen, has a own subsidiary in Asia and India and numerous representatives as well as trading partners all over the world.

*OUR PRODCUTS

Static tool holders

Live tool units

Precision tools

Tools for turning and machining centres

Tools for swiss type lathes

Tool changing and uick-change systems

Tool systems for gear production

Digital tool management

This catalogue, including all its parts, is protected by copyright. Any use outside the restricted limitations of the Copyright Act without the consent of heimatec is inadmissible and liable to prosecution. This applies in particular to duplication, translation, microfilming and storage and processing in electronic systems.

heimatec GmbH reserves the right to make technical changes at any time without giving prior notice. This applies in particular to adjustments at any time to meet new or changed international standards, or in case of further developments of our products or manufacturing processes.

The current version of our General Terms and Conditions can be found on our website.

JX-250 Ø65/75 Std. Revolver rechts

Part-#	Name	
8 010 55 033	Axial milling and drill holder ER 25 AX UT	
	Weight [kg]:	2.830
	Tool drive:	Flat (~DIN 1809)
	Shank size [mm]:	55.00
	Shank type:	BMT
	Tool adaption:	ER 25 A - u-tec
	Gear ratio [i]:	1:1
	Torque max [Nm]:	50
	Rotation max [1/min]:	6000
	Rotating direction:	same
	Coolant:	EXT
	Please note:	Combi bearing
8 010 55 109	Axial drilling and milling head ER 25 AX UT	
	Weight [kg]:	2.600
	Tool drive:	Flat (~DIN 1809)
	Shank size [mm]:	55.00
	Shank type:	BMT
	Tool adaption:	ER 25 A - u-tec
	Gear ratio [i]:	1:1
	Torque max [Nm]:	50
	Rotation max [1/min]:	12000
	Rotating direction:	same
	Coolant:	EXT
8 010 55 111	Axial drilling and milling head ER 25 AX UT IC	
	Weight [kg]:	3.000
	Tool drive:	Flat (~DIN 1809)
	Shank size [mm]:	55.00
	Shank type:	BMT
	Tool adaption:	ER 25 A - u-tec
	Gear ratio [i]:	1:1
	Torque max [Nm]:	50
	Rotation max [1/min]:	15000
	Rotating direction:	same
	Coolant:	IC/Ext
	Pressure max [bar]:	100
	Please note:	Dryrun possible
8 010 56 031	Axial drilling and milling head HT 4 IC	
	Weight [kg]:	1.760
	Tool drive:	Flat (~DIN 1809)
	Shank size [mm]:	55.00
	Shank type:	BMT
	Tool adaption:	HT 4
	Gear ratio [i]:	1:1
	Torque max [Nm]:	50
	Rotation max [1/min]:	6000
	Rotating direction:	same
	Coolant:	IC/Ext
	Pressure max [bar]:	25
	Please note:	short version





JX-250 Ø65/75 Std. Revolver rechts

Part-#	Name	
8 010 56 032	Axial drilling and milling head HT 4	
	Weight [kg]:	1.740
	Tool drive:	Flat (~DIN 1809)
	Shank size [mm]:	55.00
	Shank type:	BMT
	Tool adaption:	HT 4
	Gear ratio [i]:	1:1
	Torque max [Nm]:	50
	Rotation max [1/min]:	6000
	Rotating direction:	same
	Coolant:	EXT
	Please note:	short version
8 010 56 063	Axial milling and drill holder ER 32 AX UT	
	Weight [kg]:	3.000
	Tool drive:	Flat (~DIN 1809)
	Shank size [mm]:	55.00
	Shank type:	BMT
	Tool adaption:	ER 32 A - u-tec
	Gear ratio [i]:	1:1
	Torque max [Nm]:	50
	Rotation max [1/min]:	6000
	Rotating direction:	same
	Coolant:	EXT
	Please note:	Combi bearing
8 010 56 064	Axial milling and drill holder ER 32 AX UT IC	
	Weight [kg]:	3.020
	Tool drive:	Flat (~DIN 1809)
	Shank size [mm]:	55.00
	Tool adaption:	ER 32 A - u-tec
	Gear ratio [i]:	1:1
	Torque max [Nm]:	50
	Rotation max [1/min]:	6000
	Rotating direction:	same
	Coolant:	IC/Ext
	Pressure max [bar]:	25
	Please note:	Combi bearing
8 010 56 066	Axial drilling and milling head HT 4 IC	
	Weight [kg]:	2.930
	Tool drive:	Flat (~DIN 1809)
	Shank size [mm]:	55.00
	Shank type:	BMT
	Tool adaption:	HT 4
	Gear ratio [i]:	1:1
	Torque max [Nm]:	50
	Rotation max [1/min]:	6000
	Rotating direction:	same
	Coolant:	IC/Ext
	Pressure max [bar]:	25
	Please note:	Combi bearing

JX-250 Ø65/75 Std. Revolver rechts

Part-#	Name	
8 010 56 110	Axial drilling and milling head C 4	
	Weight [kg]:	4.750
	Notation:	180° reversible
	Tool drive:	Flat (~DIN 1809)
	Shank size [mm]:	55.00
	Shank type:	BMT
	Tool adaption:	heimatec Capto(TM) C 4
	Gear ratio [i]:	1:1
	Torque max [Nm]:	50
	Rotation max [1/min]:	6000
	Rotating direction:	same
	Coolant:	EXT
	Please note:	Check applicability; tool length check !
8 010 56 111	Axial drilling and milling head C 4 IC	
	Weight [kg]:	5.800
	Notation:	180° reversible
	Tool drive:	Flat (~DIN 1809)
	Shank size [mm]:	55.00
	Shank type:	BMT
	Machine adaption:	Centering key b 20
	Tool adaption:	heimatec Capto(TM) C 4
	Gear ratio [i]:	1:1
	Torque max [Nm]:	50
	Rotation max [1/min]:	6000
	Rotating direction:	same
	Coolant:	IC/Ext
	Pressure max [bar]:	100
	Please note:	Check applicability; tool length check !
8 010 56 120	Axial drilling and milling head C 4 IC	
	Notation:	180° reversible
	Tool drive:	Flat (~DIN 1809)
	Shank size [mm]:	55.00
	Shank type:	BMT
	Machine adaption:	Centering key b 20
	Tool adaption:	heimatec Capto(TM) C 4
	Gear ratio [i]:	1:1
	Torque max [Nm]:	50
	Rotation max [1/min]:	6000
	Rotating direction:	same
	Coolant:	IC/Ext
	Pressure max [bar]:	25
	Please note:	Check applicability; tool length check !
8 010 56 140	Axial drilling and milling head ER 32 AX UT IC	
	Weight [kg]:	3.000
	Tool drive:	Flat (~DIN 1809)
	Shank size [mm]:	55.00
	Shank type:	BMT
	Tool adaption:	ER 32 A - u-tec
	Gear ratio [i]:	1:1
	Torque max [Nm]:	50
	Rotation max [1/min]:	6000
	Rotating direction:	same
	Coolant:	IC/Ext





JX-250 Ø65/75 Std. Revolver rechts

Part-#	Name	
	Pressure max [bar]:	100
8 010 56 144	Axial drilling and milling head HT 4 IC	
	Tool drive:	Flat (~DIN 1809)
	Shank size [mm]:	55.00
	Shank type:	BMT
	Tool adaption:	HT 4
	Gear ratio [i]:	1:1
	Torque max [Nm]:	50
	Rotation max [1/min]:	6000
	Rotating direction:	same
	Coolant:	IC/Ext
	Pressure max [bar]:	100
8 010 56 151	Axial drilling and milling head ER 32 AX UT	
	Weight [kg]:	2.770
	Tool drive:	Flat (~DIN 1809)
	Shank size [mm]:	55.00
	Shank type:	BMT
	Tool adaption:	ER 32 A - u-tec
	Gear ratio [i]:	1:1
	Torque max [Nm]:	50
	Rotation max [1/min]:	12000
	Rotating direction:	same
	Coolant:	EXT
8 010 56 153	Axial drilling and milling head ER 32 AX UT IC	
	Weight [kg]:	3.180
	Tool drive:	Flat (~DIN 1809)
	Shank size [mm]:	55.00
	Shank type:	BMT
	Tool adaption:	ER 32 A - u-tec
	Gear ratio [i]:	1:1
	Torque max [Nm]:	50
	Rotation max [1/min]:	15000
	Rotating direction:	same
	Coolant:	IC/Ext
	Pressure max [bar]:	100
8 011 54 006	Axial milling head universal arbor 3/4"	
	Weight [kg]:	2.910
	Tool drive:	Flat (~DIN 1809)
	Shank size [mm]:	55.00
	Shank type:	BMT
	Tool adaption:	Universal arbor 3/4" (19,05mm)
	Gear ratio [i]:	1:1
	Torque max [Nm]:	50
	Rotation max [1/min]:	6000
	Rotating direction:	same
	Coolant:	EXT
	Please note:	Combi bearing



JX-250 Ø65/75 Std. Revolver rechts

Part-#	Name	
8 011 55 015	Axial milling head universal arbor 22	
	Weight [kg]:	3.000
	Tool drive:	Flat (~DIN 1809)
	Shank size [mm]:	55.00
	Shank type:	BMT
	Tool adaption:	Universal arbor 22
	Gear ratio [i]:	1:1
	Torque max [Nm]:	50
	Rotation max [1/min]:	6000
	Rotating direction:	same
	Coolant:	EXT
	Please note:	Combi bearing
8 013 54 005	Axial drilling and milling head ER 16 AX UT	
	Weight [kg]:	2.200
	Tool drive:	Flat (~DIN 1809)
	Shank size [mm]:	55.00
	Shank type:	BMT
	Tool adaption:	ER 16 A - u-tec
	Gear ratio [i]:	1:4
	Torque max [Nm]:	5
	Rotation max [1/min]:	24000
	Rotating direction:	same
	Coolant:	EXT
8 013 54 007	Axial drilling and milling head ER 16 AX UT IC	
	Tool drive:	Flat (~DIN 1809)
	Shank size [mm]:	55.00
	Shank type:	BMT
	Tool adaption:	ER 16 A - u-tec
	Gear ratio [i]:	1:4
	Torque max [Nm]:	5
	Rotation max [1/min]:	24000
	Rotating direction:	same
	Coolant:	IC/Ext
	Pressure max [bar]:	80
8 019 54 055	Axial drilling and milling head ER 16 M IC	
	Weight [kg]:	6.200
	Notation:	offset; 180° reversible
	Tool drive:	Flat (~DIN 1809)
	Shank size [mm]:	55.00
	Shank type:	BMT
	Tool adaption:	ER 16 M
	Gear ratio [i]:	1:2
	Torque max [Nm]:	25
	Rotation max [1/min]:	12000
	Rotating direction:	opposite
	Coolant:	IC/Ext
	Pressure max [bar]:	140
	Please note:	stronger bearing
	Offset [mm]:	42

JX-250 Ø65/75 Std. Revolver rechts

Part-#	Name	
8 019 55 018	Axial drilling and milling head ER 25 AX UT	
	Weight [kg]:	5.230
	Notation:	offset; 180° reversible
	Tool drive:	Flat (~DIN 1809)
	Shank size [mm]:	55.00
	Shank type:	BMT
	Tool adaption:	ER 25 A - u-tec
	Gear ratio [i]:	1:1
	Torque max [Nm]:	40
	Rotation max [1/min]:	6000
	Rotating direction:	opposite
	Coolant:	EXT
	Please note:	stronger bearing
	Offset [mm]:	42
8 019 55 023	Axial drilling and milling head ER 25 AX UT IC	
	Weight [kg]:	6.260
	Notation:	offset; 180° reversible
	Tool drive:	Flat (~DIN 1809)
	Shank size [mm]:	55.00
	Shank type:	BMT
	Tool adaption:	ER 25 A - u-tec
	Gear ratio [i]:	1:1
	Torque max [Nm]:	40
	Rotation max [1/min]:	6000
	Rotating direction:	opposite
	Coolant:	IC/Ext
	Pressure max [bar]:	140
	Please note:	stronger bearing
	Offset [mm]:	42
8 019 55 024	Axial drilling and milling head ER 25 AX UT	
	Weight [kg]:	5.230
	Notation:	offset; 180° reversible
	Tool drive:	Flat (~DIN 1809)
	Shank size [mm]:	55.00
	Shank type:	BMT
	Tool adaption:	ER 25 A - u-tec
	Gear ratio [i]:	1:2
	Torque max [Nm]:	25
	Rotation max [1/min]:	12000
	Rotating direction:	opposite
	Coolant:	EXT
	Please note:	stronger bearing
	Offset [mm]:	42
8 019 55 025	Axial drilling and milling head ER 25 AX UT IC	
	Weight [kg]:	6.330
	Notation:	offset; 180° reversible
	Tool drive:	Flat (~DIN 1809)
	Shank size [mm]:	55.00
	Shank type:	BMT
	Tool adaption:	ER 25 A - u-tec
	Gear ratio [i]:	1:2
	Torque max [Nm]:	25
	Rotation max [1/min]:	12000

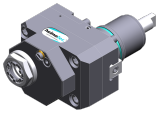
JX-250 Ø65/75 Std. Revolver rechts

Part-#	Name	
	Rotating direction:	opposite
	Coolant:	IC/Ext
	Pressure max [bar]:	140
	Please note:	stronger bearing
	Offset [mm]:	42
8 019 55 026	Axial drilling and milling head ER 25 AX UT	
	Weight [kg]:	5.300
	Notation:	offset; 180° reversible
	Tool drive:	Flat (~DIN 1809)
	Shank size [mm]:	55.00
	Shank type:	BMT
	Tool adaption:	ER 25 A - u-tec
	Gear ratio [i]:	1:3
	Torque max [Nm]:	16
	Rotation max [1/min]:	18000
	Rotating direction:	opposite
	Coolant:	EXT
	Please note:	stronger bearing
	Offset [mm]:	42
8 019 55 027	Axial drilling and milling head ER 25 AX UT IC	
	Weight [kg]:	6.350
	Notation:	offset; 180° reversible
	Tool drive:	Flat (~DIN 1809)
	Shank size [mm]:	55.00
	Shank type:	BMT
	Tool adaption:	ER 25 A - u-tec
	Gear ratio [i]:	1:3
	Torque max [Nm]:	16
	Rotation max [1/min]:	18000
	Rotating direction:	opposite
	Coolant:	IC/Ext
	Pressure max [bar]:	140
	Please note:	stronger bearing
	Offset [mm]:	42
8 019 55 028	Axial drilling and milling head ER 25 AX UT	
	Weight [kg]:	5.240
	Notation:	offset; 180° reversible
	Tool drive:	Flat (~DIN 1809)
	Shank size [mm]:	55.00
	Shank type:	BMT
	Tool adaption:	ER 25 A - u-tec
	Gear ratio [i]:	2:1
	Torque max [Nm]:	50
	Rotation max [1/min]:	3000
	Rotating direction:	opposite
	Coolant:	EXT
	Please note:	stronger bearing
	Offset [mm]:	42

JX-250 Ø65/75 Std. Revolver rechts

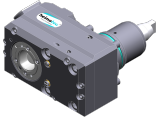
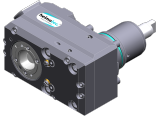
Part-#	Name	
8 019 55 029	Axial drilling and milling head ER 25 AX UT IC	
	Weight [kg]:	6.220
	Notation:	offset; 180° reversible
	Tool drive:	Flat (~DIN 1809)
	Shank size [mm]:	55.00
	Shank type:	BMT
	Tool adaption:	ER 25 A - u-tec
	Gear ratio [i]:	2:1
	Torque max [Nm]:	50
	Rotation max [1/min]:	3000
	Rotating direction:	opposite
	Coolant:	IC/Ext
	Pressure max [bar]:	140
	Please note:	stronger bearing
	Offset [mm]:	42
8 019 56 042	Axial drilling and milling head C 4 IC	
	Weight [kg]:	7.720
	Notation:	180° reversible
	Tool drive:	Flat (~DIN 1809)
	Shank size [mm]:	55.00
	Shank type:	BMT
	Tool adaption:	heimatec Capto(TM) C 4
	Gear ratio [i]:	1:1
	Torque max [Nm]:	50
	Rotation max [1/min]:	6000
	Rotating direction:	opposite
	Coolant:	IC/Ext
	Pressure max [bar]:	140
	Please note:	Check applicability; note tool length!
	Offset [mm]:	62
8 019 56 057	Axial drilling and milling head C 4 IC	
	Weight [kg]:	7.650
	Notation:	180° reversible
	Tool drive:	Flat (~DIN 1809)
	Shank size [mm]:	55.00
	Shank type:	BMT
	Tool adaption:	heimatec Capto(TM) C 4
	Gear ratio [i]:	1:1
	Torque max [Nm]:	50
	Rotation max [1/min]:	12000
	Rotating direction:	opposite
	Coolant:	IC/Ext
	Pressure max [bar]:	140
	Please note:	Check applicability; note tool length!
	Offset [mm]:	62
8 030 55 076	Angle-mill- and drill holder ER 25 AX UT	
	Weight [kg]:	6.860
	Notation:	180° reversible
	Tool drive:	Flat (~DIN 1809)
	Shank size [mm]:	55.00
	Shank type:	BMT
	Tool adaption:	ER 25 A - u-tec
	Gear ratio [i]:	1:1
	Torque max [Nm]:	50

JX-250 Ø65/75 Std. Revolver rechts

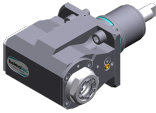
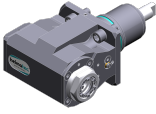
Part-#	Name	
	Rotation max [1/min]:	6000
	Rotating direction:	opposite
	Coolant:	EXT
	Please note:	Combi bearing
	Center distance [mm]:	75
8 030 55 081	Angle-mill- and drill holder ER 25 AX UT IC	
	Weight [kg]:	7.150
	Notation:	180° reversible
	Tool drive:	Flat (~DIN 1809)
	Shank size [mm]:	55.00
	Shank type:	BMT
	Tool adaption:	ER 25 A - u-tec
	Gear ratio [i]:	1:1
	Torque max [Nm]:	50
	Rotation max [1/min]:	6000
	Rotating direction:	opposite
	Coolant:	IC/Ext
	Pressure max [bar]:	140
	Please note:	Combi bearing
	Center distance [mm]:	75
8 030 55 122	Radial drilling and milling head ER 25 AX UT	
	Weight [kg]:	6.380
	Notation:	180° reversible
	Tool drive:	Flat (~DIN 1809)
	Shank size [mm]:	55.00
	Shank type:	BMT
	Tool adaption:	ER 25 A - u-tec
	Gear ratio [i]:	1:2
	Torque max [Nm]:	16
	Rotation max [1/min]:	12000
	Rotating direction:	same
	Coolant:	EXT
	Please note:	stronger bearing; check applicability;
	Center distance [mm]:	77
8 030 55 123	Radial drilling and milling head ER 25 AX UT IC	
	Weight [kg]:	6.550
	Notation:	180° reversible
	Tool drive:	Flat (~DIN 1809)
	Shank size [mm]:	55.00
	Shank type:	BMT
	Tool adaption:	ER 25 A - u-tec
	Gear ratio [i]:	1:2
	Torque max [Nm]:	16
	Rotation max [1/min]:	12000
	Rotating direction:	same
	Coolant:	IC/Ext
	Pressure max [bar]:	140
	Please note:	stronger bearing
	Center distance [mm]:	77

JX-250 Ø65/75 Std. Revolver rechts

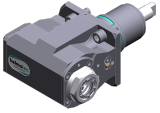
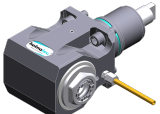
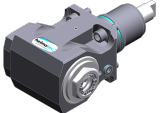
Part-#	Name
8 030 55 139	Radial drilling and milling head ER 25 AX UT IC
	Weight [kg]: 6.560 Notation: 180° reversible Tool drive: Flat (~DIN 1809) Shank size [mm]: 55.00 Shank type: BMT Tool adaption: ER 25 A - u-tec Gear ratio [i]: 1:3 Torque max [Nm]: 12 Rotation max [1/min]: 18000 Rotating direction: same Coolant: IC/Ext Pressure max [bar]: 140 Please note: stronger bearing Center distance [mm]: 77
8 030 55 140	Radial drilling and milling head ER 25 AX UT
	Weight [kg]: 6.700 Notation: 180° reversible Tool drive: Flat (~DIN 1809) Shank size [mm]: 55.00 Shank type: BMT Tool adaption: ER 25 A - u-tec Gear ratio [i]: 1:3 Torque max [Nm]: 12 Rotation max [1/min]: 18000 Rotating direction: same Coolant: EXT Please note: stronger bearing Center distance [mm]: 77
8 030 55 240	Radial drilling and milling head ER 25 AX UT
	Weight [kg]: 6.380 Notation: 180° reversible Tool drive: Flat (~DIN 1809) Shank size [mm]: 55.00 Shank type: BMT Tool adaption: ER 25 A - u-tec Gear ratio [i]: 1:1 Torque max [Nm]: 50 Rotation max [1/min]: 12000 Rotating direction: opposite Coolant: EXT Center distance [mm]: 75
8 030 55 241	Angle drilling and milling head ER 25 AX UT IC
	Weight [kg]: 6.960 Notation: 180° reversible Tool drive: Flat (~DIN 1809) Shank size [mm]: 55.00 Shank type: BMT Tool adaption: ER 25 A - u-tec Gear ratio [i]: 1:1 Torque max [Nm]: 50 Rotation max [1/min]: 12000 Rotating direction: opposite Coolant: IC/Ext

JX-250 Ø65/75 Std. Revolver rechts

Part-#	Name	
	Pressure max [bar]:	140
	Center distance [mm]:	75
8 030 56 076	Radial drilling and milling head HT 4	
	Weight [kg]:	6.970
	Notation:	180° reversible
	Tool drive:	Flat (~DIN 1809)
	Shank size [mm]:	55.00
	Shank type:	BMT
	Tool adaption:	HT 4
	Gear ratio [i]:	1:1
	Torque max [Nm]:	50
	Rotation max [1/min]:	6000
	Rotating direction:	opposite
	Coolant:	EXT
	Please note:	Combi bearing
	Center distance [mm]:	75
8 030 56 077	Radial drilling and milling head HT 4	
	Weight [kg]:	6.920
	Notation:	180° reversible
	Tool drive:	Flat (~DIN 1809)
	Shank size [mm]:	55.00
	Shank type:	BMT
	Tool adaption:	HT 4
	Gear ratio [i]:	2:1
	Torque max [Nm]:	63
	Rotation max [1/min]:	3000
	Rotating direction:	opposite
	Coolant:	EXT
	Please note:	Combi bearing
	Center distance [mm]:	75
8 030 56 087	Angle-mill- and drill holder ER 32 AX UT	
	Weight [kg]:	6.880
	Notation:	180° reversible
	Tool drive:	Flat (~DIN 1809)
	Shank size [mm]:	55.00
	Shank type:	BMT
	Tool adaption:	ER 32 A - u-tec
	Gear ratio [i]:	1:1
	Torque max [Nm]:	50
	Rotation max [1/min]:	6000
	Rotating direction:	opposite
	Coolant:	EXT
	Please note:	Combi bearing
	Center distance [mm]:	75
8 030 56 088	Angle-mill- and drill holder ER 32 AX UT IC	
	Notation:	180° reversible
	Tool drive:	Flat (~DIN 1809)
	Shank size [mm]:	55.00
	Shank type:	BMT
	Tool adaption:	ER 32 A - u-tec
	Gear ratio [i]:	1:1
	Torque max [Nm]:	50
	Rotation max [1/min]:	6000

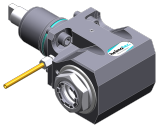

JX-250 Ø65/75 Std. Revolver rechts

Part-#	Name	
	Rotating direction:	opposite
	Coolant:	IC/Ext
	Pressure max [bar]:	140
	Please note:	Combi bearing
	Center distance [mm]:	75
8 030 56 092	Radial drilling and milling head ER 32 AX UT	
	Weight [kg]:	6.830
	Notation:	180° reversible
	Tool drive:	Flat (~DIN 1809)
	Shank size [mm]:	55.00
	Shank type:	BMT
	Tool adaption:	ER 32 A - u-tec
	Gear ratio [i]:	2:1
	Torque max [Nm]:	63
	Rotation max [1/min]:	3000
	Rotating direction:	opposite
	Coolant:	EXT
	Please note:	Combi bearing
	Center distance [mm]:	75
8 030 56 093	Radial drilling and milling head ER 32 AX UT IC	
	Weight [kg]:	7.040
	Notation:	180° reversible
	Tool drive:	Flat (~DIN 1809)
	Shank size [mm]:	55.00
	Shank type:	BMT
	Tool adaption:	ER 32 A - u-tec
	Gear ratio [i]:	2:1
	Torque max [Nm]:	63
	Rotation max [1/min]:	3000
	Rotating direction:	opposite
	Coolant:	IC/Ext
	Pressure max [bar]:	140
	Please note:	Combi bearing
	Center distance [mm]:	75
8 030 56 107	Radial drilling and milling head HT 4 IC	
	Weight [kg]:	7.180
	Notation:	180° reversible
	Tool drive:	Flat (~DIN 1809)
	Shank size [mm]:	55.00
	Shank type:	BMT
	Tool adaption:	HT 4
	Gear ratio [i]:	1:1
	Torque max [Nm]:	50
	Rotation max [1/min]:	6000
	Rotating direction:	opposite
	Coolant:	IC/Ext
	Pressure max [bar]:	140
	Please note:	Combi bearing
	Center distance [mm]:	75

JX-250 Ø65/75 Std. Revolver rechts

Part-#	Name	
8 030 56 121	Radial drilling and milling head HT 4 IC	
	Notation:	180° reversible
	Tool drive:	Flat (~DIN 1809)
	Shank size [mm]:	55.00
	Shank type:	BMT
	Tool adaption:	HT 4
	Gear ratio [i]:	1:3
	Torque max [Nm]:	12
	Rotation max [1/min]:	18000
	Rotating direction:	same
	Coolant:	IC/Ext
	Pressure max [bar]:	140
	Please note:	stronger bearing
	Center distance [mm]:	77
8 030 56 124	Radial drilling and milling head HT 4	
	Weight [kg]:	6.300
	Notation:	180° reversible
	Tool drive:	Flat (~DIN 1809)
	Shank size [mm]:	55.00
	Shank type:	BMT
	Tool adaption:	HT 4
	Gear ratio [i]:	1:3
	Torque max [Nm]:	12
	Rotation max [1/min]:	18000
	Rotating direction:	same
	Coolant:	EXT
	Please note:	stronger bearing
	Center distance [mm]:	77
8 030 56 125	Radial drilling and milling head HT 4 IC	
	Weight [kg]:	6.520
	Notation:	180° reversible
	Tool drive:	Flat (~DIN 1809)
	Shank size [mm]:	55.00
	Shank type:	BMT
	Tool adaption:	HT 4
	Gear ratio [i]:	1:2
	Torque max [Nm]:	16
	Rotation max [1/min]:	12000
	Rotating direction:	same
	Coolant:	IC/Ext
	Pressure max [bar]:	140
	Please note:	stronger bearing
	Center distance [mm]:	77
8 030 56 126	Radial drilling and milling head HT 4	
	Weight [kg]:	6.340
	Notation:	180° reversible
	Tool drive:	Flat (~DIN 1809)
	Shank size [mm]:	55.00
	Shank type:	BMT
	Tool adaption:	HT 4
	Gear ratio [i]:	1:2
	Torque max [Nm]:	16
	Rotation max [1/min]:	12000
	Rotating direction:	same
	Coolant:	EXT

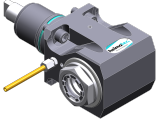

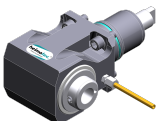
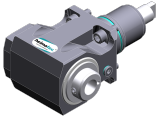
JX-250 Ø65/75 Std. Revolver rechts

Part-#	Name	
	Please note:	stronger bearing
	Center distance [mm]:	77
8 030 56 237	Radial drilling and milling head ER 32 AX UT	
	Weight [kg]:	6.500
	Notation:	180° reversible
	Tool drive:	Flat (~DIN 1809)
	Shank size [mm]:	55.00
	Shank type:	BMT
	Tool adaption:	ER 32 A - u-tec
	Gear ratio [i]:	1:1
	Torque max [Nm]:	50
	Rotation max [1/min]:	12000
	Rotating direction:	opposite
	Coolant:	EXT
	Center distance [mm]:	75
8 030 56 238	Radial drilling and milling head ER 32 AX UT IC	
	Weight [kg]:	7.200
	Notation:	180° reversible
	Tool drive:	Flat (~DIN 1809)
	Shank size [mm]:	55.00
	Shank type:	BMT
	Tool adaption:	ER 32 A - u-tec
	Gear ratio [i]:	1:1
	Torque max [Nm]:	50
	Rotation max [1/min]:	12000
	Rotating direction:	opposite
	Coolant:	IC/Ext
	Pressure max [bar]:	140
	Center distance [mm]:	75
8 030 56 256	Radial drilling and milling head HT 4	
	Notation:	180° reversible
	Tool drive:	Flat (~DIN 1809)
	Shank size [mm]:	55.00
	Shank type:	BMT
	Tool adaption:	HT 4
	Gear ratio [i]:	1:1
	Torque max [Nm]:	50
	Rotation max [1/min]:	12000
	Rotating direction:	opposite
	Coolant:	EXT
	Center distance [mm]:	75
8 030 56 257	Radial drilling and milling head HT 4 IC	
	Notation:	180° reversible
	Tool drive:	Flat (~DIN 1809)
	Shank size [mm]:	55.00
	Shank type:	BMT
	Tool adaption:	HT 4
	Gear ratio [i]:	1:1
	Torque max [Nm]:	50
	Rotation max [1/min]:	12000
	Rotating direction:	opposite
	Coolant:	IC/Ext

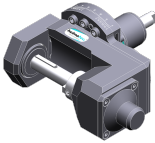

JX-250 Ø65/75 Std. Revolver rechts

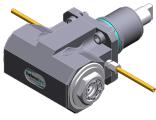
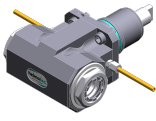
Part-#	Name	
	Pressure max [bar]:	140
	Center distance [mm]:	75
8 037 53 001	Radial disk mill head arbor 13	
	Weight [kg]:	6.960
	Tool drive:	Flat (~DIN 1809)
	Shank size [mm]:	55.00
	Shank type:	BMT
	Tool adaption:	Arbor 13
	Gear ratio [i]:	2:1
	Torque max [Nm]:	32
	Rotation max [1/min]:	3000
	Rotating direction:	opposite
	Coolant:	no
	Center distance [mm]:	76
8 037 54 007	Radial disk mill head arbor 16	
	Weight [kg]:	12.220
	Version:	± 10° turnable; at 0° position can be pinned
	Tool drive:	Flat (~DIN 1809)
	Shank size [mm]:	55.00
	Shank type:	BMT
	Tool adaption:	Arbor 16
	Gear ratio [i]:	2:1
	Torque max [Nm]:	63
	Rotation max [1/min]:	3000
	Rotating direction:	same
	Coolant:	EXT
	Please note:	strong version; stronger bearing
	Center distance [mm]:	87,5
8 037 55 007	Radial disk mill head arbor 22	
	Weight [kg]:	12.520
	Tool drive:	Flat (~DIN 1809)
	Shank size [mm]:	55.00
	Shank type:	BMT
	Tool adaption:	Arbor 22
	Gear ratio [i]:	2:1
	Torque max [Nm]:	63
	Rotation max [1/min]:	3000
	Rotating direction:	same
	Coolant:	no
	Please note:	strong version with stronger bearing
	Center distance [mm]:	87,5
8 037 55 013	Radial disk mill head arbor 1"	
	Weight [kg]:	11.640
	Tool drive:	Flat (~DIN 1809)
	Shank size [mm]:	55.00
	Shank type:	BMT
	Tool adaption:	Arbor 1" (25,4mm)
	Gear ratio [i]:	2:1
	Torque max [Nm]:	63
	Rotation max [1/min]:	3000
	Rotating direction:	same
	Coolant:	no
	Please note:	strong version with stronger bearing

JX-250 Ø65/75 Std. Revolver rechts

Part-#	Name	
	Center distance [mm]:	87,5
8 039 55 047	Radial drilling and milling head ER 25 AX UT	
	Weight [kg]:	6.800
	Notation:	180° reversible
	Employment for:	Main- and sub spindle
	Version:	double spindle
	Tool drive:	Flat (~DIN 1809)
	Shank size [mm]:	55.00
	Shank type:	BMT
	Tool adaption:	ER 25 A - u-tec
	Gear ratio [i]:	1:1
	Torque max [Nm]:	50
	Rotation max [1/min]:	12000
	Rotating direction:	same/opposite
	Coolant:	EXT
	Please note:	stronger bearing
	Center distance [mm]:	75
8 039 56 021	Radial drilling and milling head ER 32 AX UT	
	Weight [kg]:	6.600
	Notation:	180° reversible
	Employment for:	Main- and sub spindle
	Version:	double spindle
	Tool drive:	Flat (~DIN 1809)
	Shank size [mm]:	55.00
	Shank type:	BMT
	Tool adaption:	ER 32 A - u-tec
	Gear ratio [i]:	1:1
	Torque max [Nm]:	50
	Rotation max [1/min]:	12000
	Rotating direction:	same/opposite
	Coolant:	EXT
	Please note:	stronger bearing
	Center distance [mm]:	75
8 040 53 000	Universal head ± 90° adjustable ER 11 AX	
	Weight [kg]:	3.150
	Tool drive:	Flat (~DIN 1809)
	Shank size [mm]:	55.00
	Shank type:	BMT
	Tool adaption:	ER 11 A
	Gear ratio [i]:	1:1
	Torque max [Nm]:	10
	Rotation max [1/min]:	5000
	Rotating direction:	same
	Coolant:	EXT
	Center distance [mm]:	57
8 040 54 002	Universal head ± 90° adjustable ER 16	
	Weight [kg]:	3.180
	Tool drive:	Flat (~DIN 1809)
	Shank size [mm]:	55.00
	Shank type:	BMT
	Tool adaption:	ER 16
	Gear ratio [i]:	1:1
	Torque max [Nm]:	10

JX-250 Ø65/75 Std. Revolver rechts

Part-#	Name	
	Rotation max [1/min]:	6000
	Rotating direction:	same
	Coolant:	EXT
	Center distance [mm]:	57
8 040 54 033	Universal head ± 90° adjustable ER 16 AS UT IC	
	Weight [kg]:	3.320
	Tool drive:	Flat (~DIN 1809)
	Shank size [mm]:	55.00
	Shank type:	BMT
	Tool adaption:	ER 16 A - u-tec
	Gear ratio [i]:	1:1
	Torque max [Nm]:	16
	Rotation max [1/min]:	12000
	Rotating direction:	same
	Coolant:	IC/Ext
	Pressure max [bar]:	140
	Please note:	Check applicability; note center distance!
	Center distance [mm]:	46
8 043 54 000	Universal head +135°/-30° adj. ER16 AX UT	
	Weight [kg]:	9.850
	Notation:	offset; 180° reversible
	Tool drive:	Flat (~DIN 1809)
	Shank size [mm]:	55.00
	Shank type:	BMT
	Tool adaption:	ER 16 A - u-tec
	Gear ratio [i]:	1:1
	Torque max [Nm]:	25
	Rotation max [1/min]:	6000
	Rotating direction:	same
	Coolant:	EXT
	Center distance [mm]:	69
	Offset [mm]:	60
8 043 54 001	Universal head +135°/-30° adj. ER16AX UTIK	
	Weight [kg]:	9.920
	Notation:	offset; 180° reversible
	Tool drive:	Flat (~DIN 1809)
	Shank size [mm]:	55.00
	Shank type:	BMT
	Tool adaption:	ER 16 A - u-tec
	Gear ratio [i]:	1:1
	Torque max [Nm]:	25
	Rotation max [1/min]:	6000
	Rotating direction:	same
	Coolant:	IC/Ext
	Pressure max [bar]:	140
	Center distance [mm]:	69
	Offset [mm]:	60

JX-250 Ø65/75 Std. Revolver rechts

Part-#	Name	
8 043 54 002	Universal head +135°/-30° adj. ER16 AX UT	
	Weight [kg]:	9.930
	Notation:	offset; 180° reversible
	Tool drive:	Flat (~DIN 1809)
	Shank size [mm]:	55.00
	Shank type:	BMT
	Tool adaption:	ER 16 A - u-tec
	Gear ratio [i]:	1:2
	Torque max [Nm]:	12
	Rotation max [1/min]:	12000
	Rotating direction:	same
	Coolant:	EXT
	Center distance [mm]:	69
	Offset [mm]:	60
8 043 54 003	Universal head +135°/-30° adj. ER16AX UTIK	
	Weight [kg]:	9.900
	Notation:	offset
	Tool drive:	Flat (~DIN 1809)
	Shank size [mm]:	55.00
	Shank type:	BMT
	Tool adaption:	ER 16 A - u-tec
	Gear ratio [i]:	1:2
	Torque max [Nm]:	12
	Rotation max [1/min]:	12000
	Rotating direction:	same
	Coolant:	IC/Ext
	Pressure max [bar]:	140
	Please note:	180° reversible
	Center distance [mm]:	69
	Offset [mm]:	60
8 043 54 034	Universal head ± 10° adjustable ER 16 AX UT IC	
	Notation:	offset; 180° reversible
	Tool drive:	Flat (~DIN 1809)
	Shank size [mm]:	55.00
	Shank type:	BMT
	Tool adaption:	ER 16 A - u-tec
	Gear ratio [i]:	1:2
	Torque max [Nm]:	25
	Rotation max [1/min]:	12000
	Rotating direction:	same
	Coolant:	IC/Ext
	Pressure max [bar]:	140
	Please note:	Check applicability! note swivel range;
	Center distance [mm]:	62
	Offset [mm]:	48,5
8 050 54 005	Multispindle drilling head ER 16 AX UT	
	Weight [kg]:	6.100
	Notation:	offset
	Version:	2-spindles
	Tool drive:	Flat (~DIN 1809)
	Shank size [mm]:	55.00
	Shank type:	BMT
	Tool adaption:	ER 16 A - u-tec
	Gear ratio [i]:	1:2
	Torque max [Nm]:	16

JX-250 Ø65/75 Std. Revolver rechts

Part-#	Name	
	Rotation max [1/min]:	12000
	Rotating direction:	same
	Coolant:	EXT
	Offset [mm]:	56
8 050 54 014	Multispindle drilling head ER 20 AX UT IC	
	Weight [kg]:	5.920
	Notation:	offset
	Version:	2-spindles
	Tool drive:	Flat (~DIN 1809)
	Shank size [mm]:	55.00
	Shank type:	BMT
	Tool adaption:	ER 20 A - u-tec
	Gear ratio [i]:	1:1
	Torque max [Nm]:	25
	Rotation max [1/min]:	6000
	Rotating direction:	same
	Coolant:	IC/Ext
	Pressure max [bar]:	140
	Offset [mm]:	58
8 050 56 006	Multispindle drilling head C 4 IC	
	Notation:	180° reversible
	Employment for:	Main- and sub spindle
	Version:	2-spindles
	Tool drive:	Flat (~DIN 1809)
	Shank size [mm]:	55.00
	Shank type:	BMT
	Tool adaption:	heimatec Capto(TM) C 4
	Gear ratio [i]:	1:1
	Torque max [Nm]:	50/Sp.
	Rotation max [1/min]:	6000
	Rotating direction:	opposite
	Coolant:	IC/Ext
	Pressure max [bar]:	140
	Please note:	Check applicability; tool length check !
	Offset [mm]:	62
8 053 54 045	Multispindle radial head ER 16 AX UT	
	Weight [kg]:	6.850
	Notation:	180° reversible
	Version:	2-spindles
	Tool drive:	Flat (~DIN 1809)
	Shank size [mm]:	55.00
	Shank type:	BMT
	Tool adaption:	ER 16 A - u-tec
	Gear ratio [i]:	1:1
	Torque max [Nm]:	32/Sp
	Rotation max [1/min]:	12000
	Rotating direction:	same
	Coolant:	EXT
	Center distance [mm]:	75

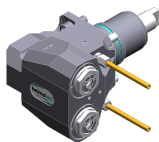



JX-250 Ø65/75 Std. Revolver rechts

Part-#	Name	
8 053 54 046	Multispindle radial head ER 16 AX UTIK	
8 053 54 047	Multispindle radial head ER 20 AX UT	
8 053 54 048	Multispindle radial head ER 20 AX UTIK	
8 068 54 000	Radial whirling unit HW 46	

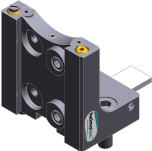
JX-250 Ø65/75 Std. Revolver rechts

Part-#	Name	
	Center distance [mm]:	65
8 224 11 003	Cut-off holder sq. 20	
	Weight [kg]:	1.040
	Employment for:	right cutting tools
	Version:	Edge on side of turret
	Shank type:	BMT
	Machine adaption:	Centering key b 20
	Tool adaption:	Sq. 20
	Coolant:	EXT
8 224 11 005	Cut-off holder sq. 20	
	Weight [kg]:	1.100
	Employment for:	left cutting tools
	Version:	Edge on center of turret
	Shank type:	BMT
	Machine adaption:	Centering key b 20
	Tool adaption:	Sq. 20
	Coolant:	EXT
8 224 11 016	Cut-off holder sq. 3/4" R 1441	
	Weight [kg]:	1.110
	Employment for:	right cutting tools
	Version:	Edge on side of turret
	Shank type:	BMT
	Machine adaption:	Centering key b 20
	Tool adaption:	Sq. 3/4" (19,05mm)
	Coolant:	EXT
8 224 11 022	Cut-off holder sq. 20	
	Weight [kg]:	1.350
	Employment for:	right cutting tools
	Version:	Edge on side of turret
	Shank type:	BMT
	Machine adaption:	Centering key b 20
	Tool adaption:	Sq. 20
	Coolant:	EXT
8 224 13 004	Cut-off holder SH 32	
	Weight [kg]:	1.000
	Employment for:	Cut-off tool 32
	Version:	Clampshaft on turret center
	Shank type:	BMT
	Machine adaption:	Centering key b 20
	Tool adaption:	Clampshaft SH 32
	Coolant:	EXT
8 224 13 007	Cut-off holder SH 32	
	Weight [kg]:	1.190
	Employment for:	Cut-off tool 32
	Version:	Clampshaft on turret side
	Shank type:	BMT
	Machine adaption:	Centering key b 20
	Tool adaption:	Clampshaft SH 32
	Coolant:	EXT

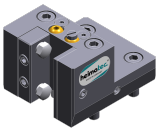
JX-250 Ø65/75 Std. Revolver rechts

Part-#	Name	
8 224 15 002	Universal turning holder sq. 25/20	
	Weight [kg]:	2.800
	Notation:	180° reversible
	Shank type:	BMT
	Machine adaption:	Centering key b 20
	Tool adaption:	Sq. 25
		Sq. 25
	Coolant:	EXT
	Please note:	With spacer strip for sq. 20
8 224 15 012	Universal turning holder sq. 1"	
	Weight [kg]:	2.720
	Shank type:	BMT
	Machine adaption:	Centering key b 20
	Tool adaption:	Sq. 1" (25,4mm)
		Sq. 1" (25,4mm)
	Coolant:	EXT
8 224 15 062	Universal turning holder sq. 25 IC	
	Weight [kg]:	3.100
	Shank type:	BMT
	Machine adaption:	Centering key b 20
	Tool adaption:	Sq. 25
		Sq. 25
	Coolant:	IC/Ext
	Pressure max [bar]:	100
	Please note:	Key rail
8 224 15 063	Universal turning holder sq. 1" IC	
	Weight [kg]:	3.100
	Shank type:	BMT
	Machine adaption:	Centering key b 20
	Tool adaption:	Sq. 1" (25,4mm)
		Sq. 1" (25,4mm)
	Coolant:	IC/Ext
	Pressure max [bar]:	100
	Please note:	Key rail
8 225 11 002	Cut-off holder sq. 20 R 1432	
	Weight [kg]:	1.120
	Employment for:	left cutting tools
	Version:	Edge on side of turret
	Shank type:	BMT
	Machine adaption:	Centering key b 20
	Tool adaption:	Sq. 20
	Coolant:	EXT
8 225 11 005	Cut-off holder sq. 20	
	Weight [kg]:	1.170
	Employment for:	right cutting tools
	Version:	Edge on center of turret
	Shank type:	BMT
	Machine adaption:	Centering key b 20
	Tool adaption:	Sq. 20
	Coolant:	EXT

JX-250 Ø65/75 Std. Revolver rechts

Part-#	Name	
8 225 11 009	Cut-off holder sq. 3/4" R 1442	
	Weight [kg]:	1.110
	Employment for:	left cutting tools
	Version:	Edge on side of turret
	Shank type:	BMT
	Machine adaption:	Centering key b 20
	Tool adaption:	Sq. 3/4" (19,05mm)
	Coolant:	EXT
8 225 11 012	Cut-off holder sq. 3/4"	
	Weight [kg]:	1.200
	Employment for:	right cutting tools
	Version:	Edge on center of turret
	Shank type:	BMT
	Machine adaption:	Centering key b 20
	Tool adaption:	Sq. 3/4" (19,05mm)
	Coolant:	EXT
8 229 16 008	Tool holder C 4 IC	
	Weight [kg]:	3.430
	Notation:	180° reversible
	Version:	right
	Shank type:	BMT
	Machine adaption:	Centering key b 20
	Tool adaption:	heimatec Capto(TM) C 4
	Coolant:	IC
	Please note:	Check applicability; note tool length!
	Offset [mm]:	55
8 229 16 009	Tool holder C 4 IC	
	Weight [kg]:	2.410
	Notation:	180° reversible
	Version:	right
	Shank type:	BMT
	Machine adaption:	Centering key b 20
	Tool adaption:	heimatec Capto(TM) C 4
	Coolant:	IC
	Please note:	Check applicability; note tool length!
	Offset [mm]:	12
8 240 14 022	Boring bar holder Ø 10 - slotted	
	Weight [kg]:	2.900
	Notation:	180° reversible
	Version:	slotted
	Shank type:	BMT
	Machine adaption:	Centering key b 20
	Tool adaption:	Ø 10
	Coolant:	EXT
	Pressure max [bar]:	100
	Center distance [mm]:	75



JX-250 Ø65/75 Std. Revolver rechts

Part-#	Name	
8 240 15 006	Collet chuck holder ER 25	
	Weight [kg]:	3.520
	Notation:	180° reversible
	Shank type:	BMT
	Machine adaption:	Centering key b 20
	Tool adaption:	ER 25
	Coolant:	IC/Ext
	Please note:	Insert reversible
	Center distance [mm]:	75
8 240 15 007	Insert drill holder 16 IC	
	Weight [kg]:	4.540
	Notation:	180° reversible
	Shank type:	BMT
	Tool adaption:	Whistle-Notch (DIN 1835 E) 16
	Coolant:	IC
	Center distance [mm]:	75
8 240 15 019	Collet chuck holder ER 25 AX UT IC	
	Weight [kg]:	3.380
	Notation:	180° reversible; offset
	Shank type:	BMT
	Machine adaption:	Centering key b 20
	Tool adaption:	ER 25 A - u-tec
	Coolant:	IC/Ext
	Center distance [mm]:	75
8 240 16 004	Tool holder HT 4 IC	
	Weight [kg]:	2.890
	Notation:	180° reversible; offset
	Shank type:	BMT
	Machine adaption:	Centering key b 20
	Tool adaption:	HT 4
	Coolant:	IC/Ext
	Center distance [mm]:	75
8 240 16 008	Collet chuck holder ER 32	
	Weight [kg]:	3.200
	Notation:	180° reversible
	Shank type:	BMT
	Machine adaption:	Centering key b 20
	Tool adaption:	ER 32
	Coolant:	IC/Ext
	Please note:	Insert reversible
	Center distance [mm]:	75
8 240 16 009	Insert drill holder 20 IC	
	Weight [kg]:	4.480
	Notation:	180° reversible
	Shank type:	BMT
	Tool adaption:	Whistle-Notch (DIN 1835 E) 20
	Coolant:	IC
	Center distance [mm]:	75

JX-250 Ø65/75 Std. Revolver rechts

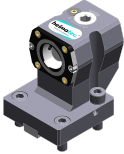
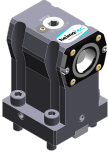
Part-#	Name	
8 240 16 030	Boring bar holder Ø 20	
	Weight [kg]:	3.940
	Notation:	180° reversible
	Shank type:	BMT
	Machine adaption:	Centering key b 20
	Tool adaption:	Ø 20
	Coolant:	IC/Ext
	Please note:	Housing rigid
	Center distance [mm]:	75
8 240 16 034	Collet chuck holder ER 32	
	Weight [kg]:	3.060
	Notation:	180° reversible; offset
	Shank type:	BMT
	Machine adaption:	Centering key b 20
	Tool adaption:	ER 32
	Coolant:	IC/Ext
	Center distance [mm]:	75
8 240 16 045	Tool holder C 4 IC	
	Weight [kg]:	2.960
	Notation:	180° reversible
	Version:	offset; right
	Shank type:	BMT
	Machine adaption:	Centering key b 20
	Tool adaption:	heimatec Capto(TM) C 4
	Coolant:	IC
	Please note:	Check applicability; note tool length!
	Center distance [mm]:	75
8 240 16 046	Tool holder C 4 IC	
	Weight [kg]:	3.480
	Notation:	180° reversible
	Version:	right
	Shank type:	BMT
	Machine adaption:	Centering key b 20
	Tool adaption:	heimatec Capto(TM) C 4
	Coolant:	IC
	Please note:	Check applicability; note tool length!
	Center distance [mm]:	75
8 240 16 072	Tool holder C 4 IC	
	Weight [kg]:	4.000
	Notation:	180° reversible
	Version:	right
	Shank type:	BMT
	Machine adaption:	Centering key b 20
	Tool adaption:	heimatec Capto(TM) C 4
	Coolant:	IC
	Please note:	Check applicability; note tool length!
	Center distance [mm]:	95



JX-250 Ø65/75 Std. Revolver rechts

Part-#	Name	
8 240 16 077	Boring bar holder Ø 20 - slotted	
	Weight [kg]:	3.120
	Notation:	180° reversible
	Version:	slotted
	Shank type:	BMT
	Machine adaption:	Centering key b 20
	Tool adaption:	Ø 20
	Coolant:	EXT
	Pressure max [bar]:	100
	Center distance [mm]:	75
8 240 17 005	Boring bar holder Ø 25	
	Weight [kg]:	3.820
	Notation:	180° reversible
	Shank type:	BMT
	Machine adaption:	Centering key b 20
	Tool adaption:	Ø 25
	Coolant:	IC/Ext
	Please note:	Housing rigid
	Center distance [mm]:	75
8 240 17 007	Boring bar holder Ø 25	
	Weight [kg]:	2.320
	Notation:	180° reversible
	Version:	offset
	Shank type:	BMT
	Machine adaption:	Centering key b 20
	Tool adaption:	Ø 25
	Coolant:	IC/Ext
	Please note:	Housing rigid
	Center distance [mm]:	75
8 240 17 011	Boring bar holder Ø 25,4 (1")	
	Weight [kg]:	3.800
	Notation:	180° reversible
	Shank type:	BMT
	Machine adaption:	Centering key b 20
	Tool adaption:	Ø 1" (25,4mm)
	Coolant:	IC/Ext
	Pressure max [bar]:	140
	Please note:	Housing rigid
	Center distance [mm]:	75
8 240 17 023	Insert drill holder 25 IC	
	Weight [kg]:	4.380
	Notation:	180° reversible
	Shank type:	BMT
	Tool adaption:	Whistle-Notch (DIN 1835 E) 25
	Coolant:	IC
	Center distance [mm]:	75



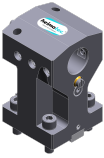

JX-250 Ø65/75 Std. Revolver rechts

Part-#	Name	
8 240 17 065	Boring bar holder Ø 25 - slotted	
	Weight [kg]:	3.670
	Notation:	180° reversible
	Shank type:	BMT
	Machine adaption:	Centering key b 20
	Tool adaption:	Ø 25
	Coolant:	EXT
	Please note:	Housing rigid
	Center distance [mm]:	75
8 240 17 078	Boring bar holder Ø 1 1/4" - slotted	
	Weight [kg]:	3.440
	Notation:	180° reversible
	Shank type:	BMT
	Machine adaption:	Centering key b 20
	Tool adaption:	Ø 1 1/4" (31,75mm)
	Coolant:	EXT
	Please note:	Housing rigid
	Center distance [mm]:	75
8 240 18 010	Boring bar holder Ø 32	
	Weight [kg]:	3.640
	Notation:	180° reversible
	Shank type:	BMT
	Machine adaption:	Centering key b 20
	Tool adaption:	Ø 32
	Coolant:	IC/Ext
	Pressure max [bar]:	140
	Please note:	Housing rigid
	Center distance [mm]:	75
8 240 18 012	Boring bar holder Ø 32 offset	
	Weight [kg]:	2.420
	Notation:	180° reversible
	Version:	offset
	Shank type:	BMT
	Machine adaption:	Centering key b 20
	Tool adaption:	Ø 32
	Coolant:	IC/Ext
	Please note:	Housing rigid
	Center distance [mm]:	75
8 240 18 016	Boring bar holder Ø 32	
	Weight [kg]:	4.370
	Notation:	180° reversible
	Shank type:	BMT
	Machine adaption:	Centering key b 20
	Tool adaption:	Ø 32
	Coolant:	IC/Ext
	Please note:	Housing rigid
	Center distance [mm]:	90

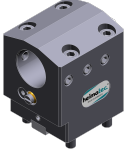

JX-250 Ø65/75 Std. Revolver rechts

Part-#	Name	
8 240 18 021	Insert drill holder 32 IC	
	Weight [kg]:	4.200
	Notation:	180° reversible
	Shank type:	BMT
	Tool adaption:	Whistle-Notch (DIN 1835 E) 32
	Coolant:	IC
	Center distance [mm]:	75
8 240 18 033	Boring bar holder Ø 1 1/4"	
	Weight [kg]:	3.630
	Notation:	180° reversible
	Shank type:	BMT
	Machine adaption:	Centering key b 20
	Tool adaption:	Ø 1 1/4" (31,75mm)
	Coolant:	IC/Ext
	Please note:	Housing rigid
	Center distance [mm]:	75
8 240 18 037	Boring bar holder Ø 1 1/2"	
	Weight [kg]:	4.540
	Notation:	180° reversible
	Shank type:	BMT
	Machine adaption:	Centering key b 20
	Tool adaption:	Ø 1 1/2" (38,1mm)
	Coolant:	IC/Ext
	Center distance [mm]:	75
8 240 18 088	Boring bar holder Ø 32 offset	
	Weight [kg]:	4.200
	Notation:	offset
	Shank type:	BMT
	Machine adaption:	Centering key b 20
	Tool adaption:	Ø 32
	Coolant:	IC/Ext
	Please note:	Front edge ø32- adapter 20mm from turret center offset
	Center distance [mm]:	75
8 240 18 098	Boring bar holder Ø 1 1/4"	
	Notation:	180° reversible
	Shank type:	BMT
	Machine adaption:	Centering key b 20
	Tool adaption:	Ø 1 1/4" (31,75mm)
	Coolant:	IC/Ext
	Please note:	Check applicability!
	Center distance [mm]:	100
8 240 18 102	Boring bar holder Ø 32 offset	
	Weight [kg]:	6.780
	Notation:	180° reversible
	Version:	offset
	Shank type:	BMT
	Machine adaption:	Centering key b 20
	Tool adaption:	Ø 32
	Coolant:	IC
	Pressure max [bar]:	100
	Please note:	Check applicability! length
	Center distance [mm]:	80

JX-250 Ø65/75 Std. Revolver rechts

Part-#	Name	
8 240 19 009	Boring bar holder Ø 40	
	Weight [kg]:	4.480
	Notation:	180° reversible
	Shank type:	BMT
	Machine adaption:	Centering key b 20
	Tool adaption:	Ø 40
	Coolant:	IC/Ext
	Center distance [mm]:	75
8 240 19 025	Insert drill holder 40 IC	
	Weight [kg]:	4.740
	Notation:	180° reversible
	Shank type:	BMT
	Tool adaption:	Whistle-Notch (DIN 1835 E) 40
	Coolant:	IC
	Center distance [mm]:	75
8 240 19 139	Boring bar holder Ø 40	
	Weight [kg]:	4.760
	Notation:	180° reversible
	Shank type:	BMT
	Machine adaption:	Centering key b 20
	Tool adaption:	Ø 40
	Coolant:	IC
	Please note:	Check applicability!
	Center distance [mm]:	100
8 240 19 142	Boring bar holder Ø 40 offset	
	Weight [kg]:	5.000
	Notation:	offset
	Shank type:	BMT
	Machine adaption:	Centering key b 20
	Tool adaption:	Ø 40
	Coolant:	IC/Ext
	Please note:	Front edge Ø40- adapter 60mm from turret center offset
	Center distance [mm]:	75
8 240 19 143	Boring bar holder Ø 40 offset	
	Weight [kg]:	4.000
	Notation:	offset
	Shank type:	BMT
	Machine adaption:	Centering key b 20
	Tool adaption:	Ø 40
	Coolant:	IC/Ext
	Please note:	Front edge Ø40- adapter 20mm from turret center offset
	Center distance [mm]:	75
8 244 12 025	Facing holder sq. 25	
	Weight [kg]:	5.160
	Shank type:	BMT
	Machine adaption:	Centering key b 20
	Tool adaption:	Sq. 25
	Coolant:	EXT
	Please note:	Check applicability; note tool length!

JX-250 Ø65/75 Std. Revolver rechts

Part-#	Name	
8 249 15 001	Double collet chuck holder ER 25	
	Weight [kg]:	4.240
	Notation:	180° reversible
	Shank type:	BMT
	Machine adaption:	Centering key b 20
	Tool adaption:	ER 25
	Coolant:	IC/Ext
	Center distance [mm]:	75
8 249 16 000	Double collet chuck holder ER 32	
	Weight [kg]:	4.000
	Notation:	180° reversible
	Shank type:	BMT
	Machine adaption:	Centering key b 20
	Tool adaption:	ER 32
	Coolant:	IC/Ext
	Center distance [mm]:	75
8 249 16 009	Double tool holder HT 4	
	Weight [kg]:	3.660
	Notation:	180° reversible
	Shank type:	BMT
	Machine adaption:	Centering key b 20
	Tool adaption:	HT 4
	Coolant:	IC/Ext
	Center distance [mm]:	75
8 249 16 015	Double tool holder C 4 IC	
	Weight [kg]:	5.370
	Notation:	180° reversible
	Employment for:	Main- and sub spindle
	Version:	right
	Shank type:	BMT
	Machine adaption:	Centering key b 20
	Tool adaption:	heimatec Capto(TM) C 4 heimatec Capto(TM) C 4
	Coolant:	IC
	Please note:	Check applicability; note tool length!
	Center distance [mm]:	75
8 249 16 027	Double tool holder C 4 IC	
	Weight [kg]:	6.280
	Notation:	180° reversible
	Employment for:	Main- and sub spindle
	Version:	right
	Shank type:	BMT
	Machine adaption:	Centering key b 20
	Tool adaption:	heimatec Capto(TM) C 4 heimatec Capto(TM) C 4
	Coolant:	IC
	Please note:	Check applicability; note tool length!
	Center distance [mm]:	95

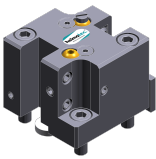

JX-250 Ø65/75 Std. Revolver rechts

Part-#	Name	
8 250 16 005	Multiple tool holder C 4 IC	
	Weight [kg]:	4.620
	Employment for:	Main- and sub spindle
	Version:	right
	Shank type:	BMT
	Machine adaption:	Centering key b 20
	Tool adaption:	heimatec Capto(TM) C 4
	Coolant:	IC
	Please note:	Check applicability; note tool length!
	Offset [mm]:	±55
8 251 11 000	Double turning holder sq. 20	
	Weight [kg]:	2.250
	Shank type:	BMT
	Machine adaption:	Centering key b 20
	Tool adaption:	Sq. 20
	Coolant:	EXT
8 251 11 003	Double turning holder sq. 20	
	Weight [kg]:	2.420
	Notation:	180° reversible
	Employment for:	right cutting tools
	Shank type:	BMT
	Machine adaption:	Centering key b 20
	Tool adaption:	Sq. 20
		Sq. 20
	Coolant:	EXT
8 251 11 007	Double turning holder sq. 3/4"	
	Weight [kg]:	2.390
	Notation:	180° reversible
	Employment for:	right cutting tools
	Shank type:	BMT
	Machine adaption:	Centering key b 20
	Tool adaption:	Sq. 3/4" (19,05mm)
		Sq. 3/4" (19,05mm)
	Coolant:	EXT
8 251 13 009	Combi multiple holder 6x sq. 3/4" IC	
	Shank type:	BMT
	Machine adaption:	Centering key b 20
	Tool adaption:	Sq. 3/4" (19,05mm)
		Sq. 3/4" (19,05mm)
		Sq. 3/4" (19,05mm)
		Sq. 3/4" (19,05mm)
	Coolant:	IC/Ext
	Pressure max [bar]:	100
	Please note:	Key rail
8 251 13 010	Combi multiple holder 3x sq. 3/4" IC	
	Shank type:	BMT
	Machine adaption:	Centering key b 20
	Tool adaption:	Sq. 3/4" (19,05mm)
		Sq. 3/4" (19,05mm)
	Coolant:	IC/Ext
	Pressure max [bar]:	100
	Please note:	Key rail



JX-250 Ø65/75 Std. Revolver rechts

Part-#	Name	
8 251 14 064	Combi multiple holder 3x sq. 20 IC	
	Weight [kg]:	3.950
	Employment for:	Main spindle
	Shank type:	BMT
	Machine adaption:	Centering key b 20
	Tool adaption:	Sq. 20
		Sq. 20
	Coolant:	IC/Ext
	Pressure max [bar]:	100
8 251 14 066	Combi multiple holder 6x sq. 20 IC	
	Weight [kg]:	6.780
	Shank type:	BMT
	Machine adaption:	Centering key b 20
	Tool adaption:	Sq. 20
		Sq. 20
		Sq. 20
		Sq. 20
	Coolant:	IC/Ext
	Pressure max [bar]:	100
	Please note:	Key rail
8 251 14 094	Combi multiple holder 3x sq. 20 IC	
	Weight [kg]:	3.820
	Employment for:	Sub spindle
	Shank type:	BMT
	Machine adaption:	Centering key b 20
	Tool adaption:	Sq. 20
		Sq. 20
	Coolant:	IC/Ext
	Pressure max [bar]:	100
	Please note:	Key rail
8 251 15 048	Combi double turning holder sq. 25 IC	
	Notation:	180° reversible
	Employment for:	Main- and sub spindle
	Shank type:	BMT
	Machine adaption:	Centering key b 20
	Tool adaption:	Sq. 25
		Sq. 25
		Sq. 25
		Sq. 25
	Coolant:	IC/Ext
	Pressure max [bar]:	100
	Please note:	Key rail
8 251 16 011	Multiple tool holder C 4 IC	
	Weight [kg]:	5.100
	Employment for:	Sub spindle
	Version:	right
	Shank type:	BMT
	Machine adaption:	Centering key b 20
	Tool adaption:	heimatec Capto(TM) C 4
		heimatec Capto(TM) C 4 - 15°
	Coolant:	IC
	Please note:	Check applicability; note tool length!
	Offset [mm]:	64

JX-250 Ø65/75 Std. Revolver rechts

Part-#	Name	
		64
8 253 17 105	Multiple boring bar holder 2x Ø 25	
	Weight [kg]:	5.560
	Notation:	180° reversible
	Employment for:	Main- and sub spindle
	Shank type:	BMT
	Machine adaption:	Centering key b 20
	Tool adaption:	Ø 25
		Ø 25 - 15°
	Coolant:	IC/Ext
	Please note:	Check applicability!
	Center distance [mm]:	75
8 259 12 010	Multiple turning holder 2x sq. 20	
	Weight [kg]:	2.890
	Notation:	180° reversible
	Version:	Y-axes offset
	Shank type:	BMT
	Machine adaption:	Centering key b 20
	Tool adaption:	Sq. 20
		Sq. 20
	Coolant:	EXT
8 261 18 003	Tool holder for centering insert	
	Weight [kg]:	5.960
	Notation:	180° reversible
	Shank type:	BMT
	Machine adaption:	Centering key b 20
	Tool adaption:	Ø 32
	Coolant:	EXT
	Please note:	Price without centering point
	Center distance [mm]:	55 or 75
8 263 19 002	Tool holder with rotating centering point	
	Weight [kg]:	4.280
	Notation:	180° reversible
	Shank type:	BMT
	Machine adaption:	Centering key b 20
	Rotation max [1/min]:	6000
	Coolant:	EXT
	Please note:	Taper roller bearings
	Center distance [mm]:	75
8 320 12 010	Cut-off holder, height adjustable SH 26 IC	
	Weight [kg]:	1.680
	Notation:	180° reversible
	Shank type:	BMT
	Machine adaption:	Centering key b 20
	Tool adaption:	Clampshaft SH 26
	Coolant:	IC/Ext
	Pressure max [bar]:	70

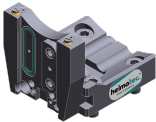
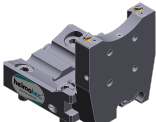
JX-250 Ø65/75 Std. Revolver rechts

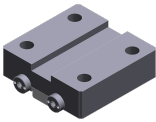
Part-#	Name	
8 320 12 020	Cut-off holder, height adjustable SH 26 IC	
	Notation:	180° reversible
	Shank type:	BMT
	Machine adaption:	Centering key b 20
	Tool adaption:	Clampshaft SH 26
	Coolant:	IC/Ext
	Pressure max [bar]:	70
	Please note:	with offset cut-off tool holder
8 320 13 002	Cut-off holder, height adjustable SH 32 IC	
	Weight [kg]:	1.570
	Notation:	180° reversible
	Shank type:	BMT
	Machine adaption:	Centering key b 20
	Tool adaption:	Clampshaft SH 32
	Coolant:	IC/Ext
	Pressure max [bar]:	70
8 320 13 010	Cut-off holder, height adjustable SH 32 IC	
	Weight [kg]:	1.730
	Notation:	180° reversible
	Shank type:	BMT
	Machine adaption:	Centering key b 20
	Tool adaption:	Clampshaft SH 32
	Coolant:	IC/Ext
	Pressure max [bar]:	70
	Please note:	Clampshaft internal
8 320 13 015	Cut-off holder, height adjustable SH 32 IC	
	Weight [kg]:	1.830
	Notation:	180° reversible
	Shank type:	BMT
	Machine adaption:	Centering key b 20
	Tool adaption:	Clampshaft SH 32
	Coolant:	IC/Ext
	Pressure max [bar]:	70
	Please note:	with offset cut-off tool holder
8 782 16 001	Spacer plate 20mm	
	Shank type:	BMT
	Machine adaption:	Centering key b 20
	Tool adaption:	Centering key slot b 20
	Coolant:	EXT
	Please note:	Plate without fastening screws !
8 782 16 003	Spacer plate 25mm	
	Shank type:	BMT
	Machine adaption:	Centering key b 20
	Tool adaption:	Centering key slot b 20
	Coolant:	EXT
	Please note:	Plate without fastening screws !

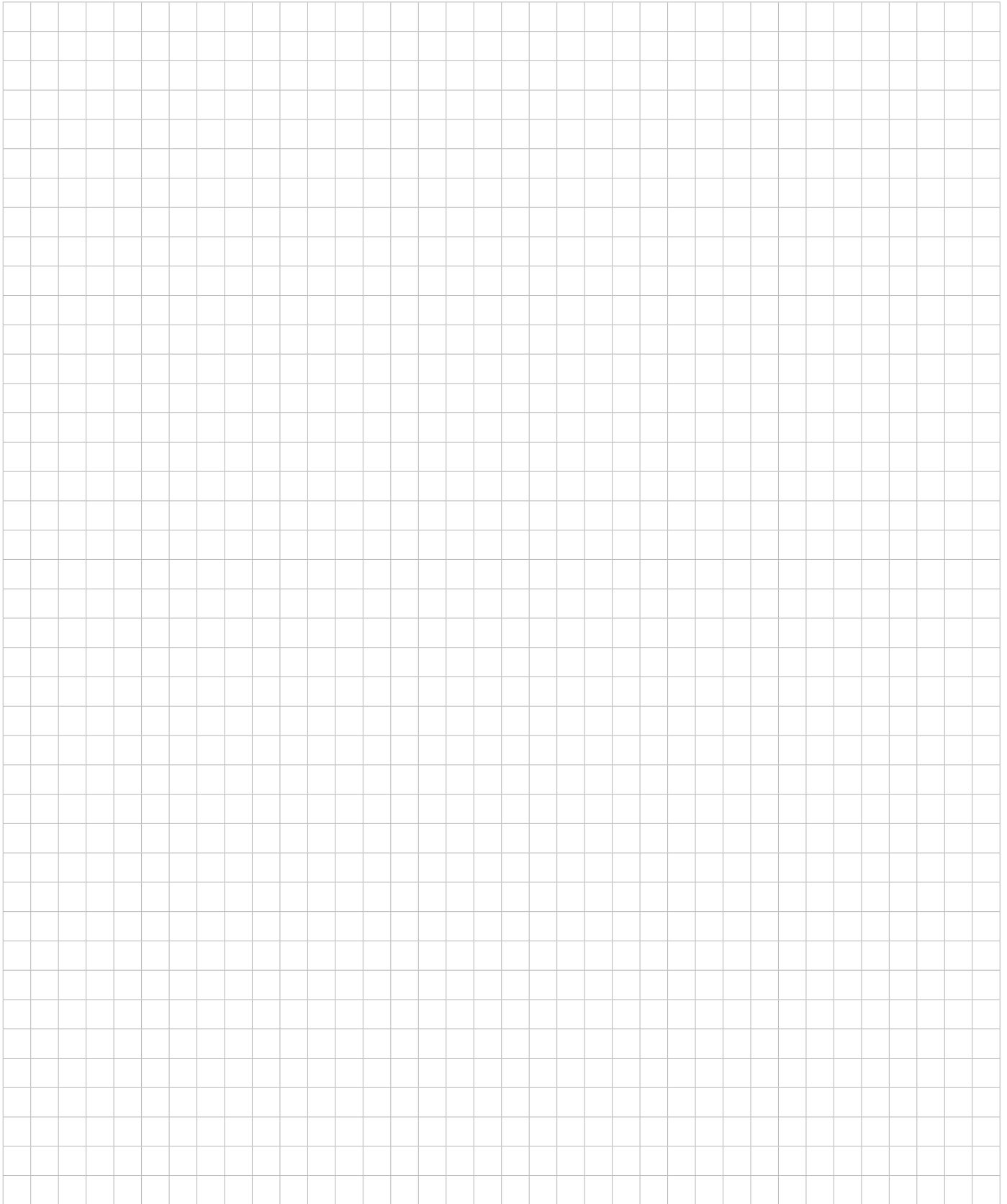

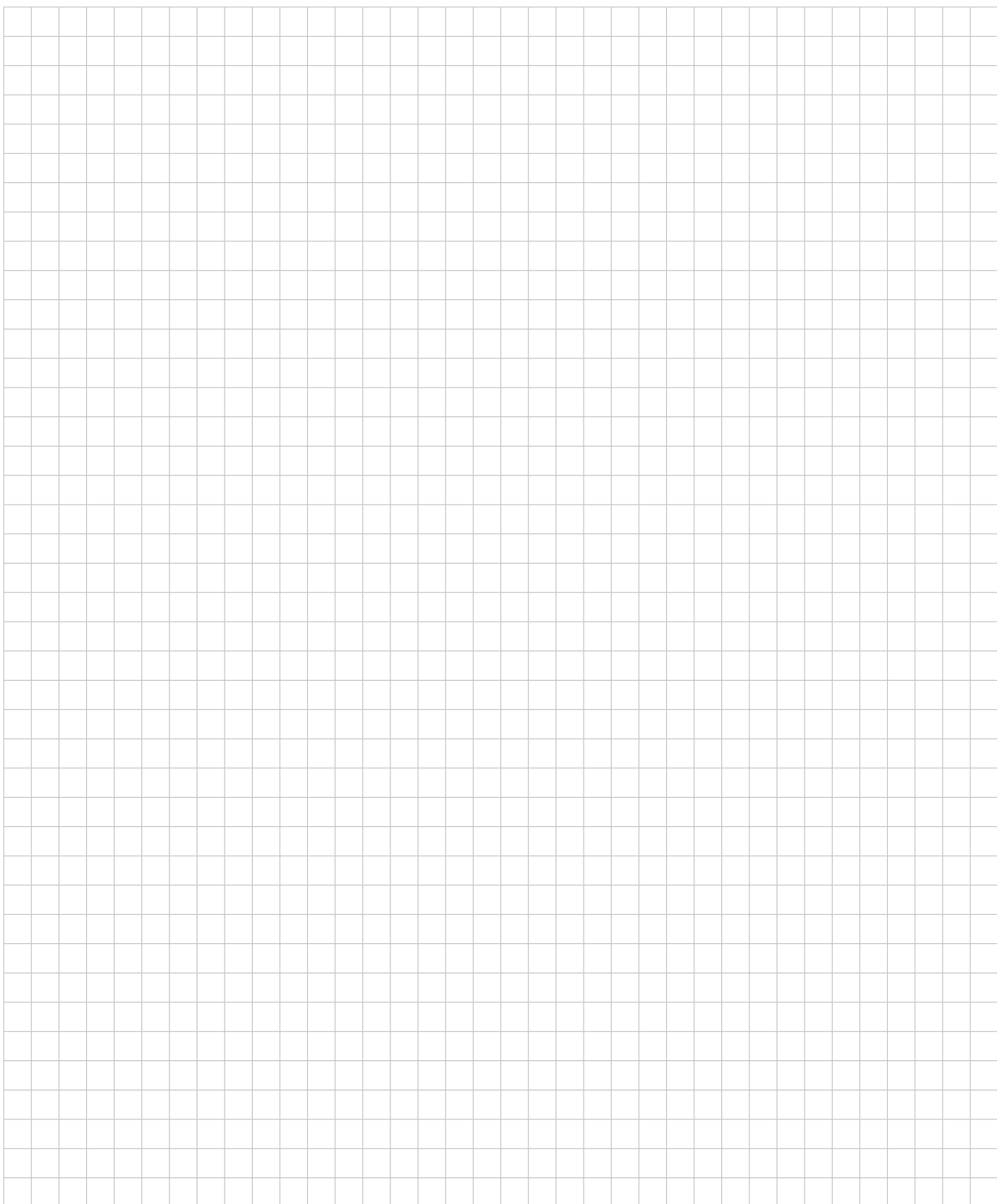

heimatec.u-tec®

heimatec.com

Products / Tool change systems /
u-tec® Tool-changing system



versions see catalog

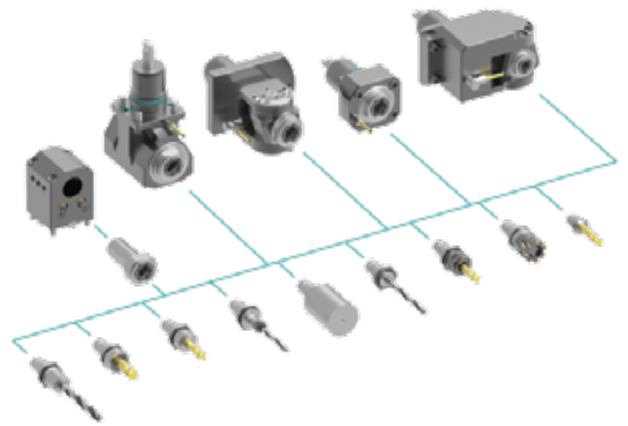

heimatec.easy-quick

heimatec.com

Products / Tool change systems /
easy-quick HT quick-changing system



versions see catalog

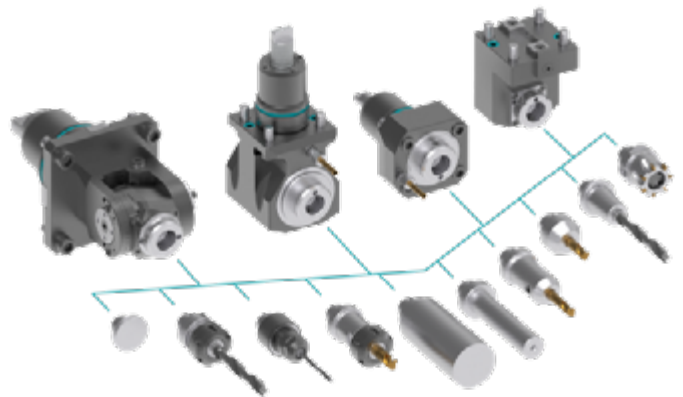

heimatec.Capto™

heimatec.com

Products / Tool change systems /
heimatec.Capto™ quick-changing system



versions see catalog

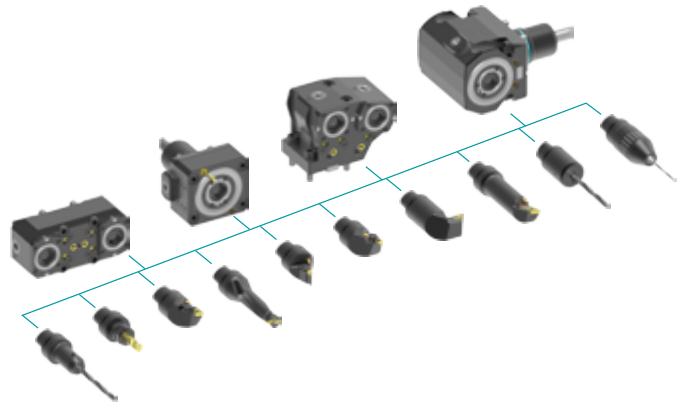

heimatec.accessories

heimatec.com

Products / Accessories



versions see catalog





● heimatec overseas branches

○ global representations of heimatec

heimatec[®]

heimatec GmbH
Präzisionswerkzeuge
Carl-Benz-Str. 4
77871 Renchen
Germany

T +49 7843 9466 0
www.heimatec.com
info@heimatec.com

Please find the contact details of our worldwide trading partners on our website:
<https://heimatec.com/business-partners>