

HAAS

**DS-30/Y - Hybrid**  
**VB 12**



# High-tech from heimatec - heimatec - Tools and systems for productive turning and milling

heimatec belongs to the international technology and quality leaders for precision tools and specializes in the development and production of high-precision static and live tools for all CNC lathes, CNC turn-/mill machines and CNC machining centers.

The range of products\* spans from static BMT and VDI tool holders, live tools up to highly complex customer-specific individual solutions. heimatec, headquartered in Renchen, has a own subsidiary in Asia and India and numerous representatives as well as trading partners all over the world.

## \*OUR PRODCUTS

Static tool holders

Live tool units

Precision tools

Tools for turning and machining centres

Tools for swiss type lathes

Tool changing and uick-change systems

Tool systems for gear production

Digital tool management



This catalogue, including all its parts, is protected by copyright. Any use outside the restricted limitations of the Copyright Act without the consent of heimatec is inadmissible and liable to prosecution. This applies in particular to duplication, translation, microfilming and storage and processing in electronic systems.

**heimatec GmbH** reserves the right to make technical changes at any time without giving prior notice. This applies in particular to adjustments at any time to meet new or changed international standards, or in case of further developments of our products or manufacturing processes.

The current version of our General Terms and Conditions can be found on our website.

Part-#	Name	
<b>8 010 45 107</b>	<b>Axial drilling and milling head ER 25</b>	
	Weight [kg]:	3.500
	Tool drive:	Coupling
	Shank size [mm]:	40.00
	Shank type:	VDI
	Tool adaption:	ER 25
	Gear ratio [i]:	1:1
	Torque max [Nm]:	50
	Rotation max [1/min]:	6000
	Rotating direction:	same
	Coolant:	EXT
	Please note:	round housing Ø 84
<b>8 010 45 116</b>	<b>Axial drilling and milling head ER 25 IC</b>	
	Weight [kg]:	3.710
	Tool drive:	Coupling
	Shank size [mm]:	40.00
	Shank type:	VDI
	Tool adaption:	ER 25
	Gear ratio [i]:	1:1
	Torque max [Nm]:	50
	Rotation max [1/min]:	6000
	Rotating direction:	same
	Coolant:	IC/Ext
	Pressure max [bar]:	25
	Please note:	round housing ø 84
<b>8 010 45 167</b>	<b>Axial drilling and milling head Weldon 16</b>	
	Weight [kg]:	3.440
	Tool drive:	Coupling
	Shank size [mm]:	40.00
	Shank type:	VDI
	Tool adaption:	Weldon (DIN 1835 b) 16
	Gear ratio [i]:	1:1
	Torque max [Nm]:	50
	Rotation max [1/min]:	6000
	Rotating direction:	same
	Coolant:	EXT
	Please note:	round housing ø 84
<b>8 010 46 177</b>	<b>Axial drilling and milling head ER 32 AX UT IC</b>	
	Weight [kg]:	3.710
	Tool drive:	Coupling
	Shank size [mm]:	40.00
	Shank type:	VDI
	Tool adaption:	ER 32 A - u-tec
	Gear ratio [i]:	1:1
	Torque max [Nm]:	50
	Rotation max [1/min]:	6000
	Rotating direction:	same
	Coolant:	IC/Ext
	Pressure max [bar]:	25
	Please note:	round housing Ø 84



Part-#	Name	
<b>8 010 46 188</b>	<b>Axial drilling and milling head ER 32 AX UT</b>	
	Weight [kg]:	3.440
	Tool drive:	Coupling
	Shank size [mm]:	40.00
	Shank type:	VDI
	Tool adaption:	ER 32 A - u-tec
	Gear ratio [i]:	1:1
	Torque max [Nm]:	50
	Rotation max [1/min]:	6000
	Rotating direction:	same
	Coolant:	EXT
	Please note:	round housing ø 84
<b>8 010 46 207</b>	<b>Axial drilling and milling head ER 32</b>	
	Weight [kg]:	3.560
	Tool drive:	Coupling
	Shank size [mm]:	40.00
	Shank type:	VDI
	Tool adaption:	ER 32
	Gear ratio [i]:	1:1
	Torque max [Nm]:	50
	Rotation max [1/min]:	6000
	Rotating direction:	same
	Coolant:	EXT
	Please note:	round housing ø 84
<b>8 010 46 215</b>	<b>Axial drilling and milling head ER 32 AX UT IC</b>	
	Tool drive:	Coupling
	Shank size [mm]:	40.00
	Shank type:	VDI
	Tool adaption:	ER 32 A - u-tec
	Gear ratio [i]:	1:1
	Torque max [Nm]:	50
	Rotation max [1/min]:	6000
	Rotating direction:	same
	Coolant:	IC/Ext
	Pressure max [bar]:	100
	Please note:	round housing ø 84; dryrun possible
<b>8 010 46 274</b>	<b>Axial drilling and milling head ER 32 IC</b>	
	Weight [kg]:	3.690
	Tool drive:	Coupling
	Shank size [mm]:	40.00
	Shank type:	VDI
	Tool adaption:	ER 32
	Gear ratio [i]:	1:1
	Torque max [Nm]:	50
	Rotation max [1/min]:	6000
	Rotating direction:	same
	Coolant:	IC/Ext
	Pressure max [bar]:	25
	Please note:	round housing ø 84

Part-#	Name	
<b>8 010 47 090</b>	<b>Axial drilling and milling head HT 5</b>	
	Weight [kg]:	3.280
	Tool drive:	Coupling
	Shank size [mm]:	40.00
	Shank type:	VDI
	Tool adaption:	HT 5
	Gear ratio [i]:	1:1
	Torque max [Nm]:	50
	Rotation max [1/min]:	6000
	Rotating direction:	same
	Coolant:	EXT
	Please note:	round housing Ø 84
<b>8 010 47 091</b>	<b>Axial drilling and milling head HT 5 IC</b>	
	Weight [kg]:	3.700
	Tool drive:	Coupling
	Shank size [mm]:	40.00
	Shank type:	VDI
	Tool adaption:	HT 5
	Gear ratio [i]:	1:1
	Torque max [Nm]:	50
	Rotation max [1/min]:	6000
	Rotating direction:	same
	Coolant:	IC/Ext
	Pressure max [bar]:	25
	Please note:	round housing Ø 84
<b>8 010 47 116</b>	<b>Axial drilling and milling head ER 40</b>	
	Weight [kg]:	3.700
	Tool drive:	Coupling
	Shank size [mm]:	40.00
	Shank type:	VDI
	Tool adaption:	ER 40
	Gear ratio [i]:	1:1
	Torque max [Nm]:	50
	Rotation max [1/min]:	6000
	Rotating direction:	same
	Coolant:	EXT
	Please note:	stronger bearing, round housing ø84
<b>8 013 44 007</b>	<b>Axial drilling and milling head ER 16 AX UT</b>	
	Weight [kg]:	3.050
	Tool drive:	Coupling
	Shank size [mm]:	40.00
	Shank type:	VDI
	Tool adaption:	ER 16 A - u-tec
	Gear ratio [i]:	1:4
	Torque max [Nm]:	5
	Rotation max [1/min]:	24000
	Rotating direction:	same
	Coolant:	EXT

Part-#	Name	
<b>8 019 45 078</b>	<b>Axial drilling and milling head ER 25</b>	
	Weight [kg]:	8.060
	Notation:	offset
	Employment for:	Main spindle
	Version:	left
	Tool drive:	Coupling
	Shank size [mm]:	40.00
	Shank type:	VDI
	Tool adaption:	ER 25
	Gear ratio [i]:	1:1
	Torque max [Nm]:	50
	Rotation max [1/min]:	6000
	Rotating direction:	same
	Coolant:	EXT
	Offset [mm]:	95
<b>8 019 45 123</b>	<b>Axial drilling and milling head ER 25 AX UT</b>	
	Weight [kg]:	7.220
	Notation:	offset
	Version:	left
	Tool drive:	Coupling
	Shank size [mm]:	40.00
	Shank type:	VDI
	Tool adaption:	ER 25 A - u-tec
	Gear ratio [i]:	1:3
	Torque max [Nm]:	16
	Rotation max [1/min]:	15000
	Rotating direction:	opposite
	Coolant:	EXT
	Please note:	stronger bearing
	Offset [mm]:	50
<b>8 019 45 155</b>	<b>Axial drilling and milling head ER 25 AX UT IC</b>	
	Weight [kg]:	7.300
	Notation:	offset
	Version:	left
	Tool drive:	Coupling
	Shank size [mm]:	40.00
	Shank type:	VDI
	Tool adaption:	ER 25 A - u-tec
	Gear ratio [i]:	1:3
	Torque max [Nm]:	16
	Rotation max [1/min]:	15000
	Rotating direction:	opposite
	Coolant:	IC/Ext
	Pressure max [bar]:	140
	Please note:	stronger bearing
	Offset [mm]:	50
<b>8 019 46 082</b>	<b>Axial drilling and milling head ER 32</b>	
	Weight [kg]:	8.640
	Notation:	offset
	Version:	double spindle
	Tool drive:	Coupling
	Shank size [mm]:	40.00
	Shank type:	VDI
	Tool adaption:	ER 32
	Gear ratio [i]:	1:1

Part-#	Name	
	Torque max [Nm]:	50
	Rotation max [1/min]:	4000
	Rotating direction:	same/opposite
	Coolant:	EXT
	Offset [mm]:	95
<b>8 019 46 095</b>	<b>Axial drilling and milling head ER 32 AX UT</b>	
	Weight [kg]:	7.210
	Notation:	offset
	Version:	left
	Tool drive:	Coupling
	Shank size [mm]:	40.00
	Shank type:	VDI
	Tool adaption:	ER 32 A - u-tec
	Gear ratio [i]:	1:2
	Torque max [Nm]:	25
	Rotation max [1/min]:	12000
	Rotating direction:	opposite
	Coolant:	EXT
	Please note:	stronger bearing
	Offset [mm]:	50
<b>8 019 46 123</b>	<b>Axial drilling and milling head ER 32 AX UT</b>	
	Weight [kg]:	14.980
	Notation:	offset
	Version:	double spindle
	Tool drive:	Coupling
	Shank size [mm]:	40.00
	Shank type:	VDI
	Tool adaption:	ER 32 A - u-tec
	Gear ratio [i]:	1:1
	Torque max [Nm]:	50
	Rotation max [1/min]:	6000
	Rotating direction:	same/opposite
	Coolant:	EXT
	Offset [mm]:	162
<b>8 019 46 163</b>	<b>Axial drilling and milling head ER 32 AX UT IC</b>	
	Weight [kg]:	7.280
	Notation:	offset
	Version:	left
	Tool drive:	Coupling
	Shank size [mm]:	40.00
	Shank type:	VDI
	Tool adaption:	ER 32 A - u-tec
	Gear ratio [i]:	1:2
	Torque max [Nm]:	25
	Rotation max [1/min]:	12000
	Rotating direction:	opposite
	Coolant:	IC/Ext
	Pressure max [bar]:	140
	Please note:	stronger bearing
	Offset [mm]:	50

Part-#	Name	
<b>8 019 46 220</b>	<b>Axial drilling and milling head ER 32 AX UT</b>	
	Weight [kg]:	8.000
	Notation:	offset
	Version:	left
	Tool drive:	Coupling
	Shank size [mm]:	40.00
	Shank type:	VDI
	Tool adaption:	ER 32 A - u-tec
	Gear ratio [i]:	1:1
	Torque max [Nm]:	50
	Rotation max [1/min]:	6000
	Rotating direction:	opposite
	Coolant:	EXT
	Please note:	stronger bearing
	Offset [mm]:	50
<b>8 019 47 045</b>	<b>Axial drilling and milling head ER 40</b>	
	Notation:	offset
	Employment for:	Main spindle
	Version:	left
	Tool drive:	Coupling
	Shank size [mm]:	40.00
	Shank type:	VDI
	Tool adaption:	ER 40
	Gear ratio [i]:	2:1
	Torque max [Nm]:	80
	Rotation max [1/min]:	3000
	Rotating direction:	opposite
	Coolant:	EXT
	Please note:	stronger bearing
	Offset [mm]:	50
<b>8 019 47 046</b>	<b>Axial drilling and milling head ER 40 IC</b>	
	Weight [kg]:	7.600
	Notation:	offset
	Version:	left
	Tool drive:	Coupling
	Shank size [mm]:	40.00
	Shank type:	VDI
	Tool adaption:	ER 40
	Gear ratio [i]:	2:1
	Torque max [Nm]:	80
	Rotation max [1/min]:	3000
	Rotating direction:	opposite
	Coolant:	IC/Ext
	Pressure max [bar]:	140
	Please note:	stronger bearing
	Offset [mm]:	50
<b>8 030 44 077</b>	<b>Radial drilling and milling head ER 16 AX UT</b>	
	Weight [kg]:	6.670
	Version:	left
	Tool drive:	Coupling
	Shank size [mm]:	40.00
	Shank type:	VDI
	Tool adaption:	ER 16 A - u-tec
	Gear ratio [i]:	1:4
	Torque max [Nm]:	5

Part-#	Name	
	Rotation max [1/min]:	24000
	Rotating direction:	opposite
	Coolant:	EXT
	Center distance [mm]:	69
<b>8 030 45 180</b>	<b>Radial drilling and milling head ER 25</b>	
	Weight [kg]:	5.510
	Version:	left
	Tool drive:	Coupling
	Shank size [mm]:	40.00
	Shank type:	VDI
	Tool adaption:	ER 25
	Gear ratio [i]:	1:1
	Torque max [Nm]:	50
	Rotation max [1/min]:	6000
	Rotating direction:	opposite
	Coolant:	EXT
	Center distance [mm]:	69
<b>8 030 46 155</b>	<b>Radial drilling and milling head ER 32 IC</b>	
	Weight [kg]:	6.160
	Version:	left
	Tool drive:	Coupling
	Shank size [mm]:	40.00
	Shank type:	VDI
	Tool adaption:	ER 32
	Gear ratio [i]:	1:1
	Torque max [Nm]:	50
	Rotation max [1/min]:	6000
	Rotating direction:	opposite
	Coolant:	IC/Ext
	Pressure max [bar]:	140
	Center distance [mm]:	69
<b>8 030 46 173</b>	<b>Radial drilling and milling head ER 32</b>	
	Weight [kg]:	5.650
	Version:	left
	Tool drive:	Coupling
	Shank size [mm]:	40.00
	Shank type:	VDI
	Tool adaption:	ER 32
	Gear ratio [i]:	1:1
	Torque max [Nm]:	50
	Rotation max [1/min]:	6000
	Rotating direction:	opposite
	Coolant:	EXT
	Center distance [mm]:	69
<b>8 030 46 194</b>	<b>Radial drilling and milling head ER 32</b>	
	Weight [kg]:	6.750
	Version:	left
	Tool drive:	Coupling
	Shank size [mm]:	40.00
	Shank type:	VDI
	Tool adaption:	ER 32
	Gear ratio [i]:	1:2
	Torque max [Nm]:	16
	Rotation max [1/min]:	12000

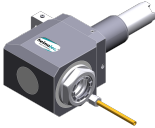
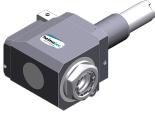
Part-#	Name	
	Rotating direction:	opposite
	Coolant:	EXT
	Please note:	stronger bearing
	Center distance [mm]:	69
<b>8 030 46 321</b>	<b>Radial drilling and milling head ER 32 AX UT</b>	
	Weight [kg]:	5.430
	Version:	left
	Tool drive:	Coupling
	Shank size [mm]:	40.00
	Shank type:	VDI
	Tool adaption:	ER 32 A - u-tec
	Gear ratio [i]:	1:1
	Torque max [Nm]:	50
	Rotation max [1/min]:	6000
	Rotating direction:	opposite
	Coolant:	EXT
	Center distance [mm]:	69
<b>8 030 46 330</b>	<b>Radial drilling and milling head ER 32 AX UT IC</b>	
	Weight [kg]:	5.940
	Version:	left
	Tool drive:	Coupling
	Shank size [mm]:	40.00
	Shank type:	VDI
	Tool adaption:	ER 32 A - u-tec
	Gear ratio [i]:	1:1
	Torque max [Nm]:	50
	Rotation max [1/min]:	6000
	Rotating direction:	opposite
	Coolant:	IC/Ext
	Pressure max [bar]:	140
	Center distance [mm]:	69
<b>8 030 46 396</b>	<b>Radial drilling and milling head ER 32 AX UT</b>	
	Weight [kg]:	5.380
	Version:	left
	Tool drive:	Coupling
	Shank size [mm]:	40.00
	Shank type:	VDI
	Tool adaption:	ER 32 A - u-tec
	Gear ratio [i]:	2:1
	Torque max [Nm]:	63
	Rotation max [1/min]:	3000
	Rotating direction:	opposite
	Coolant:	EXT
	Center distance [mm]:	69
<b>8 030 46 397</b>	<b>Radial drilling and milling head ER 32 AX UT</b>	
	Weight [kg]:	6.740
	Version:	left
	Tool drive:	Coupling
	Shank size [mm]:	40.00
	Shank type:	VDI
	Tool adaption:	ER 32 A - u-tec
	Gear ratio [i]:	1:2
	Torque max [Nm]:	16

Part-#	Name	
	Rotation max [1/min]:	12000
	Rotating direction:	opposite
	Coolant:	EXT
	Please note:	stronger bearing
	Center distance [mm]:	69
<b>8 030 46 412</b>	<b>Radial drilling and milling head ER 32 AX UT IC</b>	
	Weight [kg]:	7.120
	Version:	left
	Tool drive:	Coupling
	Shank size [mm]:	40.00
	Shank type:	VDI
	Tool adaption:	ER 32 A - u-tec
	Gear ratio [i]:	1:2
	Torque max [Nm]:	16
	Rotation max [1/min]:	12000
	Rotating direction:	opposite
	Coolant:	IC/Ext
	Pressure max [bar]:	140
	Please note:	stronger bearing
	Center distance [mm]:	69
<b>8 030 47 069</b>	<b>Radial drilling and milling head HT 5</b>	
	Weight [kg]:	5.510
	Version:	left
	Tool drive:	Coupling
	Shank size [mm]:	40.00
	Shank type:	VDI
	Tool adaption:	HT 5
	Gear ratio [i]:	1:1
	Torque max [Nm]:	50
	Rotation max [1/min]:	6000
	Rotating direction:	opposite
	Coolant:	EXT
	Center distance [mm]:	69
<b>8 030 47 083</b>	<b>Radial drilling and milling head HT 5 IC</b>	
	Weight [kg]:	6.110
	Version:	left
	Tool drive:	Coupling
	Shank size [mm]:	40.00
	Shank type:	VDI
	Tool adaption:	HT 5
	Gear ratio [i]:	1:1
	Torque max [Nm]:	50
	Rotation max [1/min]:	6000
	Rotating direction:	opposite
	Coolant:	IC/Ext
	Pressure max [bar]:	140
	Center distance [mm]:	69
<b>8 030 47 133</b>	<b>Radial drilling and milling head Weldon 25</b>	
	Weight [kg]:	7.000
	Version:	left
	Tool drive:	Coupling
	Shank size [mm]:	40.00
	Shank type:	VDI
	Tool adaption:	Weldon (DIN 1835 b) 25

Part-#	Name	
	Gear ratio [i]:	2:1
	Torque max [Nm]:	63
	Rotation max [1/min]:	3000
	Rotating direction:	opposite
	Coolant:	EXT
	Please note:	Combi bearing
	Center distance [mm]:	69
<b>8 030 47 154</b>	<b>Radial drilling and milling head ER 40 AX UT</b>	
	Weight [kg]:	6.360
	Version:	left
	Tool drive:	Coupling
	Shank size [mm]:	40.00
	Shank type:	VDI
	Tool adaption:	ER 40 A - u-tec
	Gear ratio [i]:	1:1
	Torque max [Nm]:	50
	Rotation max [1/min]:	6000
	Rotating direction:	opposite
	Coolant:	EXT
	Please note:	stronger bearing
	Center distance [mm]:	69
<b>8 030 47 159</b>	<b>Radial drilling and milling head ER 40 AX UT IC</b>	
	Version:	left
	Tool drive:	Coupling
	Shank size [mm]:	40.00
	Shank type:	VDI
	Tool adaption:	ER 40 A - u-tec
	Gear ratio [i]:	1:1
	Torque max [Nm]:	50
	Rotation max [1/min]:	6000
	Rotating direction:	opposite
	Coolant:	IC/Ext
	Pressure max [bar]:	140
	Please note:	stronger bearing
	Center distance [mm]:	69
<b>8 031 45 036</b>	<b>Radial milling head universal arbor 22</b>	
	Weight [kg]:	5.710
	Version:	left
	Tool drive:	Coupling
	Shank size [mm]:	40.00
	Shank type:	VDI
	Tool adaption:	Universal arbor 22
	Gear ratio [i]:	1:1
	Torque max [Nm]:	50
	Rotation max [1/min]:	6000
	Rotating direction:	opposite
	Coolant:	EXT
	Center distance [mm]:	69

Part-#	Name	
<b>8 031 45 047</b>	<b>Radial milling head universal arbor 22</b>	
	Weight [kg]:	6.300
	Version:	left
	Tool drive:	Coupling
	Shank size [mm]:	40.00
	Shank type:	VDI
	Tool adaption:	Universal arbor 22
	Gear ratio [i]:	2:1
	Torque max [Nm]:	63
	Rotation max [1/min]:	3000
	Rotating direction:	opposite
	Coolant:	EXT
	Please note:	Combi bearing
	Center distance [mm]:	69
<b>8 033 46 064</b>	<b>Radial drilling and milling head ER 32</b>	
	Weight [kg]:	7.780
	Notation:	offset
	Version:	left
	Tool drive:	Coupling
	Shank size [mm]:	40.00
	Shank type:	VDI
	Tool adaption:	ER 32
	Gear ratio [i]:	1:1
	Torque max [Nm]:	50
	Rotation max [1/min]:	6000
	Rotating direction:	same
	Coolant:	EXT
	Center distance [mm]:	100
<b>8 033 46 123</b>	<b>Radial drilling and milling head ER 32 AX UT</b>	
	Weight [kg]:	7.640
	Notation:	offset
	Version:	left
	Tool drive:	Coupling
	Shank size [mm]:	40.00
	Shank type:	VDI
	Tool adaption:	ER 32 A - u-tec
	Gear ratio [i]:	1:1
	Torque max [Nm]:	50
	Rotation max [1/min]:	6000
	Rotating direction:	same
	Coolant:	EXT
	Center distance [mm]:	100
<b>8 033 47 036</b>	<b>Radial drilling and milling head HT 5</b>	
	Weight [kg]:	7.800
	Notation:	offset
	Version:	left
	Tool drive:	Coupling
	Shank size [mm]:	40.00
	Shank type:	VDI
	Tool adaption:	HT 5
	Gear ratio [i]:	1:1
	Torque max [Nm]:	50
	Rotation max [1/min]:	6000
	Rotating direction:	same
	Coolant:	EXT

Part-#	Name	
	Center distance [mm]:	100
<b>8 033 47 037</b>	<b>Radial drilling and milling head HT 5 IC</b>	
	Notation:	offset
	Version:	left
	Tool drive:	Coupling
	Shank size [mm]:	40.00
	Shank type:	VDI
	Tool adaption:	HT 5
	Gear ratio [i]:	1:1
	Torque max [Nm]:	50
	Rotation max [1/min]:	6000
	Rotating direction:	same
	Coolant:	IC/Ext
	Pressure max [bar]:	25
	Center distance [mm]:	100
<b>8 034 46 010</b>	<b>Radial milling head universal arbor 27 IC</b>	
	Weight [kg]:	10.190
	Notation:	offset
	Version:	left
	Tool drive:	Coupling
	Shank size [mm]:	40.00
	Shank type:	VDI
	Tool adaption:	Universal arbor 27
	Gear ratio [i]:	3:1
	Torque max [Nm]:	80
	Rotation max [1/min]:	2000
	Rotating direction:	same
	Coolant:	IC/Ext
	Pressure max [bar]:	140
	Please note:	With spring-loaded spindle; combi bearing
	Center distance [mm]:	100
<b>8 040 44 082</b>	<b>Universal head ± 90° adjustable ER 16 AX UT</b>	
	Version:	left
	Tool drive:	Coupling
	Shank size [mm]:	40.00
	Shank type:	VDI
	Tool adaption:	ER 16 A - u-tec
	Gear ratio [i]:	1:1
	Torque max [Nm]:	25
	Rotation max [1/min]:	6000
	Rotating direction:	opposite
	Coolant:	EXT
	Center distance [mm]:	87
<b>8 040 44 084</b>	<b>Universal head ± 90° adjustable ER 16 AX UT IC</b>	
	Version:	left
	Tool drive:	Coupling
	Shank size [mm]:	40.00
	Shank type:	VDI
	Tool adaption:	ER 16 A - u-tec
	Gear ratio [i]:	1:1
	Torque max [Nm]:	25
	Rotation max [1/min]:	6000
	Rotating direction:	opposite
	Coolant:	IC/Ext

Part-#	Name	
	Pressure max [bar]:	140
	Center distance [mm]:	87
<b>8 040 44 086</b>	<b>Universal head ± 90° adjustable ER 16 AX UT</b>	
	Weight [kg]:	5.260
	Version:	left
	Tool drive:	Coupling
	Shank size [mm]:	40.00
	Shank type:	VDI
	Tool adaption:	ER 16 A - u-tec
	Gear ratio [i]:	1:2
	Torque max [Nm]:	12
	Rotation max [1/min]:	12000
	Rotating direction:	opposite
	Coolant:	EXT
	Center distance [mm]:	87
<b>8 040 44 088</b>	<b>Universal head ± 90° adjustable ER 16 AX UT IC</b>	
	Version:	left
	Tool drive:	Coupling
	Shank size [mm]:	40.00
	Shank type:	VDI
	Tool adaption:	ER 16 A - u-tec
	Gear ratio [i]:	1:2
	Torque max [Nm]:	12
	Rotation max [1/min]:	12000
	Rotating direction:	opposite
	Coolant:	IC/Ext
	Pressure max [bar]:	140
	Center distance [mm]:	87
<b>8 040 45 040</b>	<b>Universal head ± 90° adjustable ER 25 AX UT</b>	
	Weight [kg]:	5.490
	Version:	left
	Tool drive:	Coupling
	Shank size [mm]:	40.00
	Shank type:	VDI
	Tool adaption:	ER 25 A - u-tec
	Gear ratio [i]:	1:1
	Torque max [Nm]:	25
	Rotation max [1/min]:	6000
	Rotating direction:	opposite
	Coolant:	EXT
	Center distance [mm]:	87
<b>8 040 45 052</b>	<b>Universal head ± 90° adjustable ER 25 AX UT</b>	
	Weight [kg]:	5.540
	Version:	left; 1x15° position can be pinned
	Tool drive:	Coupling
	Shank size [mm]:	40.00
	Shank type:	VDI
	Tool adaption:	ER 25 A - u-tec
	Gear ratio [i]:	1:1
	Torque max [Nm]:	25
	Rotation max [1/min]:	6000
	Rotating direction:	opposite
	Coolant:	EXT

Part-#	Name	
	Center distance [mm]:	87
<b>8 040 45 075</b>	<b>Universal head ± 90° adjustable ER 25 AX UT IC</b>	
	Weight [kg]:	5.500
	Version:	left
	Tool drive:	Coupling
	Shank size [mm]:	40.00
	Shank type:	VDI
	Tool adaption:	ER 25 A - u-tec
	Gear ratio [i]:	1:1
	Torque max [Nm]:	25
	Rotation max [1/min]:	6000
	Rotating direction:	opposite
	Coolant:	IC/Ext
	Pressure max [bar]:	140
	Center distance [mm]:	87
<b>8 053 44 021</b>	<b>Multispindle radial head ER 16 AX UT</b>	
	Weight [kg]:	7.230
	Version:	left; 2-spindles
	Tool drive:	Coupling
	Shank size [mm]:	40.00
	Shank type:	VDI
	Tool adaption:	ER 16 A - u-tec
	Gear ratio [i]:	1:1
	Torque max [Nm]:	25
	Rotation max [1/min]:	6000
	Rotating direction:	same
	Coolant:	EXT
	Center distance [mm]:	69
<b>8 202 43 000</b>	<b>Basic holder transversal set SZ 40</b>	
	Weight [kg]:	1.560
	Shank size [mm]:	40.00
	Shank type:	VDI
	Tool adaption:	Interface SZ 40
	Coolant:	EXT
<b>8 224 15 027</b>	<b>Universal turning holder sq. 25</b>	
	Weight [kg]:	3.300
	Notation:	180° reversible
	Version:	long
	Shank type:	BMT
	Machine adaption:	Centering bore ø 20
	Tool adaption:	Sq. 25
	Coolant:	EXT
<b>8 240 15 017</b>	<b>Boring bar holder Ø 16</b>	
	Weight [kg]:	3.550
	Notation:	180° reversible
	Shank type:	VDI
	Machine adaption:	Centering bore ø 20
	Tool adaption:	Ø 16
	Coolant:	IC/Ext
	Center distance [mm]:	31,75

Part-#	Name	
<b>8 240 16 029</b>	<b>Boring bar holder Ø 20</b>	
	Weight [kg]:	3.700
	Notation:	180° reversible
	Shank type:	VDI
	Machine adaption:	Centering bore ø 20
	Tool adaption:	Ø 20
	Coolant:	IC/Ext
	Center distance [mm]:	31,75
<b>8 240 17 057</b>	<b>Boring bar holder Ø 25</b>	
	Weight [kg]:	3.370
	Notation:	180° reversible
	Shank type:	VDI
	Machine adaption:	Centering bore ø 20
	Tool adaption:	Ø 25
	Coolant:	IC/Ext
	Center distance [mm]:	31,75
<b>8 240 18 031</b>	<b>Boring bar holder Ø 32</b>	
	Weight [kg]:	3.370
	Notation:	180° reversible
	Shank type:	BMT
	Machine adaption:	Centering bore ø 20
	Tool adaption:	Ø 32
	Coolant:	IC/Ext
	Center distance [mm]:	31,75
<b>8 240 18 058</b>	<b>Boring bar holder Ø 1 1/2"</b>	
	Weight [kg]:	4.430
	Notation:	180° reversible
	Shank type:	BMT
	Machine adaption:	Centering bore ø 20
	Tool adaption:	Ø 1 1/2" (38,1mm)
	Coolant:	IC/Ext
	Center distance [mm]:	61,4
<b>8 240 19 068</b>	<b>Boring bar holder Ø 40</b>	
	Weight [kg]:	2.850
	Notation:	180° reversible
	Shank type:	VDI
	Machine adaption:	Centering bore ø 20
	Tool adaption:	Ø 40
	Coolant:	IC/Ext
	Center distance [mm]:	31,75
<b>8 240 19 069</b>	<b>Boring bar holder Ø 50</b>	
	Weight [kg]:	2.100
	Notation:	180° reversible
	Shank type:	VDI
	Machine adaption:	Centering bore ø 20
	Tool adaption:	Ø 50
	Coolant:	IC/Ext
	Center distance [mm]:	33,5

Part-#	Name	
<b>8 244 15 012</b>	<b>Combi facing holder sq. 25</b>	
	Weight [kg]:	3.230
	Notation:	180° reversible
	Shank type:	BMT
	Machine adaption:	Centering key slot b 20
	Tool adaption:	Sq. 25
	Coolant:	EXT
<b>8 251 15 020</b>	<b>Combi double turning holder sq. 25</b>	
	Weight [kg]:	4.570
	Notation:	180° reversible
	Version:	long
	Shank type:	BMT
	Machine adaption:	Centering key slot b 20
	Tool adaption:	Sq. 25
	Coolant:	EXT
<b>8 251 15 021</b>	<b>Combi double turning holder sq. 1"</b>	
	Notation:	180° reversible
	Version:	long
	Shank type:	BMT
	Machine adaption:	Centering key slot b 20
	Tool adaption:	Sq. 1" (25,4mm)
	Coolant:	EXT
<b>8 251 15 022</b>	<b>Combi double turning holder sq. 25</b>	
	Weight [kg]:	2.600
	Notation:	180° reversible
	Version:	short
	Shank type:	BMT
	Machine adaption:	Centering key slot b 20
	Tool adaption:	Sq. 25
	Coolant:	EXT
<b>8 251 15 023</b>	<b>Combi double turning holder sq. 1"</b>	
	Notation:	180° reversible
	Version:	short
	Shank type:	BMT
	Machine adaption:	Centering key slot b 20
	Tool adaption:	Sq. 1" (25,4mm)
	Coolant:	EXT
<b>8 253 15 012</b>	<b>Double boring bar holder Ø 3/4"</b>	
	Notation:	180° reversible
	Version:	short
	Shank type:	BMT
	Machine adaption:	Centering bore ø 20
	Tool adaption:	Ø 3/4" (19,05mm)
	Coolant:	IC/Ext
	Please note:	Center [mm] 45,72(1,8")/83,82(3,3")

Part-#	Name	
<b>8 253 15 013</b>	<b>Double boring bar holder Ø 3/4"</b>	
	Notation:	180° reversible; offset
	Version:	long
	Shank type:	BMT
	Machine adaption:	Centering key slot b 20
	Tool adaption:	Ø 3/4" (19,05mm)
	Coolant:	IC/Ext
	Center distance [mm]:	76,20(3,0)/114,30(4,5")
<b>8 253 16 006</b>	<b>Double boring bar holder Ø 20</b>	
	Weight [kg]:	6.510
	Notation:	180° reversible
	Version:	short
	Shank type:	BMT
	Machine adaption:	Centering bore ø 20
	Tool adaption:	Ø 20
	Coolant:	IC/Ext
	Please note:	Center [mm] 45,72(1,8)/83,82(3,3")
<b>8 253 16 007</b>	<b>Double boring bar holder Ø 20</b>	
	Weight [kg]:	3.940
	Notation:	180° reversible; offset
	Version:	long
	Shank type:	BMT
	Machine adaption:	Centering key slot b 20
	Tool adaption:	Ø 20
	Coolant:	IC/Ext
	Center distance [mm]:	76,20(3,0)/114,30(4,5")
<b>8 253 17 026</b>	<b>Double boring bar holder Ø 25</b>	
	Weight [kg]:	6.240
	Notation:	180° reversible
	Version:	short
	Shank type:	BMT
	Machine adaption:	Centering bore ø 20
	Tool adaption:	Ø 25
	Coolant:	IC/Ext
	Please note:	Center [mm] 45,72(1,8)/83,82(3,3")
<b>8 253 17 043</b>	<b>Double boring bar holder Ø 25</b>	
	Notation:	180° reversible; offset
	Version:	long
	Shank type:	BMT
	Machine adaption:	Centering key slot b 20
	Tool adaption:	Ø 25
	Coolant:	IC/Ext
	Center distance [mm]:	76,20(3,0)/114,30(4,5")
<b>8 320 42 018</b>	<b>Cut-off holder, height adjustable SH 26 IC</b>	
	Version:	universal
	Shank size [mm]:	40.00
	Shank type:	VDI
	Tool adaption:	Clampshaft SH 26
	Coolant:	IC/Ext
	Pressure max [bar]:	70

HAAS

## DS-30/Y - Hybrid VB 12

heimatec®

Part-#	Name
--------	------

**8 320 43 009**

**Cut-off holder, height adjustable SH 32 IC**



Weight [kg]: 2.480  
Version: universal  
Shank size [mm]: 40.00  
Shank type: VDI  
Tool adaption: Clampshaft SH 32  
Coolant: IC/Ext  
Pressure max [bar]: 70

**8 320 49 005**

**Cut-off holder, height adjustable 845 IC**

Weight [kg]: 2.700  
Version: universal  
Shank size [mm]: 40.00  
Shank type: VDI  
Tool adaption:  System 845  
Coolant: IC  
Pressure max [bar]: 70

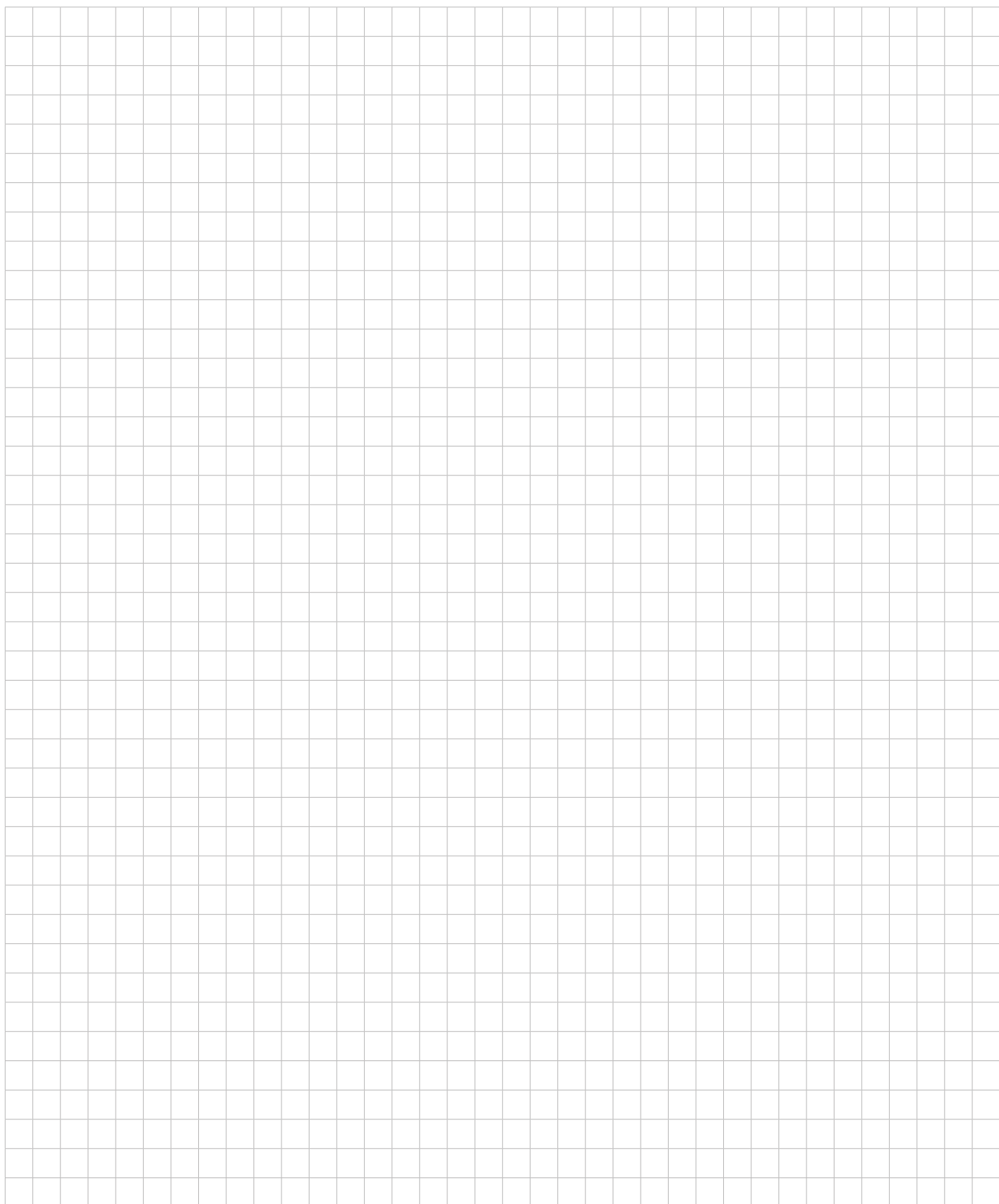



## heimatec.u-tec®

heimatec.com

Products / Tool change systems /  
u-tec® Tool-changing system



versions see catalog



## heimatec.easy-quick

heimatec.com

Products / Tool change systems /  
easy-quick HT quick-changing system



versions see catalog



## heimatec.Capto™

heimatec.com

Products / Tool change systems /  
heimatec.Capto™ quick-changing system



versions see catalog

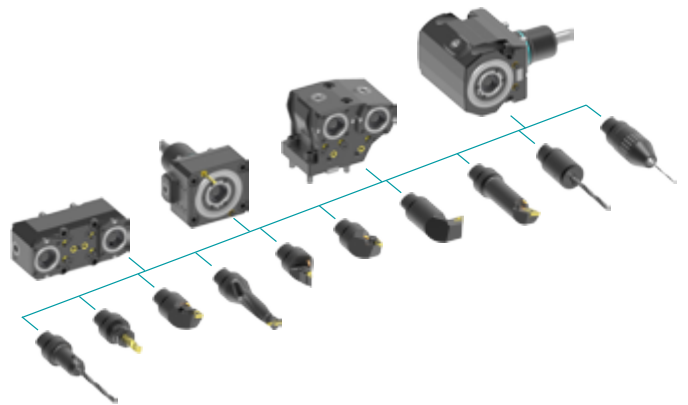

## heimatec.accessories

heimatec.com

Products / Accessories



versions see catalog





● heimatec overseas branches

○ global representations of heimatec

**heimatec**<sup>®</sup>

**heimatec GmbH**  
Präzisionswerkzeuge  
Carl-Benz-Str. 4  
77871 Renchen  
Germany

T +49 7843 9466 0  
[www.heimatec.com](http://www.heimatec.com)  
[info@heimatec.com](mailto:info@heimatec.com)

Please find the contact details of our worldwide trading partners on our website:  
<https://heimatec.com/business-partners>