

Nakamura
NTM 3



High-tech from heimatec - heimatec - Tools and systems for productive turning and milling

heimatec belongs to the international technology and quality leaders for precision tools and specializes in the development and production of high-precision static and live tools for all CNC lathes, CNC turn-/mill machines and CNC machining centers.

The range of products* spans from static BMT and VDI tool holders, live tools up to highly complex customer-specific individual solutions. heimatec, headquartered in Renchen, has a own subsidiary in Asia and India and numerous representatives as well as trading partners all over the world.

*OUR PRODCUTS

Static tool holders

Live tool units

Precision tools

Tools for turning and machining centres

Tools for swiss type lathes

Tool changing and uick-change systems



Tool systems for gear production

Digital tool management

This catalogue, including all its parts, is protected by copyright. Any use outside the restricted limitations of the Copyright Act without the consent of heimatec is inadmissible and liable to prosecution. This applies in particular to duplication, translation, microfilming and storage and processing in electronic systems.

heimatec GmbH reserves the right to make technical changes at any time without giving prior notice. This applies in particular to adjustments at any time to meet new or changed international standards, or in case of further developments of our products or manufacturing processes.

The current version of our General Terms and Conditions can be found on our website.

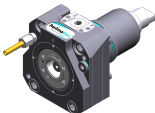
Part-#	Name	
8 010 55 033	Axial milling and drill holder ER 25 AX UT	
	Weight [kg]:	2.830
	Tool drive:	Flat (~DIN 1809)
	Shank size [mm]:	55.00
	Shank type:	BMT
	Tool adaption:	ER 25 A - u-tec
	Gear ratio [i]:	1:1
	Torque max [Nm]:	50
	Rotation max [1/min]:	6000
	Rotating direction:	same
	Coolant:	EXT
	Please note:	Combi bearing
8 010 55 035	Axial milling and drill holder ER 25 AX UT IC	
	Weight [kg]:	2.860
	Tool drive:	Flat (~DIN 1809)
	Shank size [mm]:	55.00
	Shank type:	BMT
	Tool adaption:	ER 25 A - u-tec
	Gear ratio [i]:	1:1
	Torque max [Nm]:	50
	Rotation max [1/min]:	6000
	Rotating direction:	same
	Coolant:	IC/Ext
	Pressure max [bar]:	100
	Please note:	Combi bearing; high pressure version; dryrun possible
8 010 55 049	Axial drilling and milling head Weldon 16	
	Weight [kg]:	3.140
	Tool drive:	Flat (~DIN 1809)
	Shank size [mm]:	55.00
	Shank type:	BMT
	Tool adaption:	Weldon (DIN 1835 b) 16
	Gear ratio [i]:	1:1
	Torque max [Nm]:	50
	Rotation max [1/min]:	6000
	Rotating direction:	same
	Coolant:	EXT
	Please note:	Combi bearing
8 010 55 068	Axial drilling and milling head C 3	
	Notation:	180° reversible
	Tool drive:	Flat (~DIN 1809)
	Shank type:	BMT
	Tool adaption:	heimatec Capto(TM) C 3
	Gear ratio [i]:	1:1
	Torque max [Nm]:	32
	Rotation max [1/min]:	8000
	Rotating direction:	same
	Coolant:	EXT

Part-#	Name
--------	------

8 010 55 069

Axial drilling and milling head C 3 IC



Notation: 180° reversible
 Tool drive: Flat (~DIN 1809)
 Shank type: BMT
 Tool adaption: heimatec Capto(TM) C 3
 Gear ratio [i]: 1:1
 Torque max [Nm]: 32
 Rotation max [1/min]: 8000
 Rotating direction: same
 Coolant: IC/Ext
 Pressure max [bar]: 100

8 010 55 078

Axial drilling and milling head Weldon 3/4" IC



Weight [kg]: 3.200
 Tool drive: Flat (~DIN 1809)
 Shank size [mm]: 55.00
 Shank type: BMT
 Tool adaption: Weldon (DIN 1835 b) 3/4" (19,05mm)
 Gear ratio [i]: 1:1
 Torque max [Nm]: 50
 Rotation max [1/min]: 6000
 Rotating direction: same
 Coolant: IC/Ext
 Pressure max [bar]: 25
 Please note: Combi bearing

8 010 55 081

Axial drilling and milling head Weldon 3/4"



Weight [kg]: 3.200
 Tool drive: Flat (~DIN 1809)
 Shank size [mm]: 55.00
 Shank type: BMT
 Tool adaption: Weldon (DIN 1835 b) 3/4" (19,05mm)
 Gear ratio [i]: 1:1
 Torque max [Nm]: 50
 Rotation max [1/min]: 6000
 Rotating direction: same
 Coolant: EXT
 Please note: Combi bearing

8 010 55 092

Axial drilling and milling head ER 25 AX UT IC



Weight [kg]: 2.870
 Tool drive: Flat (~DIN 1809)
 Shank size [mm]: 55.00
 Shank type: BMT
 Tool adaption: ER 25 A - u-tec
 Gear ratio [i]: 1:1
 Torque max [Nm]: 50
 Rotation max [1/min]: 6000
 Rotating direction: same
 Coolant: IC air
 Pressure max [bar]: 10
 Please note: Combi bearing

Part-#	Name
--------	------

8 010 55 109



Axial drilling and milling head ER 25 AX UT

Weight [kg]:	2.600
Tool drive:	Flat (~DIN 1809)
Shank size [mm]:	55.00
Shank type:	BMT
Tool adaption:	ER 25 A - u-tec
Gear ratio [i]:	1:1
Torque max [Nm]:	50
Rotation max [1/min]:	12000
Rotating direction:	same
Coolant:	EXT

8 010 55 111



Axial drilling and milling head ER 25 AX UT IC

Weight [kg]:	3.000
Tool drive:	Flat (~DIN 1809)
Shank size [mm]:	55.00
Shank type:	BMT
Tool adaption:	ER 25 A - u-tec
Gear ratio [i]:	1:1
Torque max [Nm]:	50
Rotation max [1/min]:	15000
Rotating direction:	same
Coolant:	IC/Ext
Pressure max [bar]:	100
Please note:	Dryrun possible

8 010 56 031

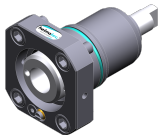

Axial drilling and milling head HT 4 IC

Weight [kg]:	1.760
Tool drive:	Flat (~DIN 1809)
Shank size [mm]:	55.00
Shank type:	BMT
Tool adaption:	HT 4
Gear ratio [i]:	1:1
Torque max [Nm]:	50
Rotation max [1/min]:	6000
Rotating direction:	same
Coolant:	IC/Ext
Pressure max [bar]:	25
Please note:	short version

8 010 56 032

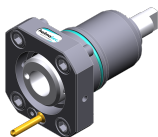

Axial drilling and milling head HT 4

Weight [kg]:	1.740
Tool drive:	Flat (~DIN 1809)
Shank size [mm]:	55.00
Shank type:	BMT
Tool adaption:	HT 4
Gear ratio [i]:	1:1
Torque max [Nm]:	50
Rotation max [1/min]:	6000
Rotating direction:	same
Coolant:	EXT
Please note:	short version

Part-#	Name	
8 010 56 059	Axial drilling and milling head HT 4	
	Weight [kg]:	2.880
	Tool drive:	Flat (~DIN 1809)
	Shank size [mm]:	55.00
	Shank type:	BMT
	Tool adaption:	HT 4
	Gear ratio [i]:	1:1
	Torque max [Nm]:	50
	Rotation max [1/min]:	6000
	Rotating direction:	same
	Coolant:	EXT
	Please note:	Combi bearing
8 010 56 063	Axial milling and drill holder ER 32 AX UT	
	Weight [kg]:	3.000
	Tool drive:	Flat (~DIN 1809)
	Shank size [mm]:	55.00
	Shank type:	BMT
	Tool adaption:	ER 32 A - u-tec
	Gear ratio [i]:	1:1
	Torque max [Nm]:	50
	Rotation max [1/min]:	6000
	Rotating direction:	same
	Coolant:	EXT
	Please note:	Combi bearing
8 010 56 064	Axial milling and drill holder ER 32 AX UT IC	
	Weight [kg]:	3.020
	Tool drive:	Flat (~DIN 1809)
	Shank size [mm]:	55.00
	Tool adaption:	ER 32 A - u-tec
	Gear ratio [i]:	1:1
	Torque max [Nm]:	50
	Rotation max [1/min]:	6000
	Rotating direction:	same
	Coolant:	IC/Ext
	Pressure max [bar]:	25
	Please note:	Combi bearing
8 010 56 065	Axial milling and drill holder ER 32 AX UT IC	
	Weight [kg]:	3.020
	Tool drive:	Flat (~DIN 1809)
	Shank size [mm]:	55.00
	Shank type:	BMT
	Tool adaption:	ER 32 A - u-tec
	Gear ratio [i]:	1:1
	Torque max [Nm]:	50
	Rotation max [1/min]:	6000
	Rotating direction:	same
	Coolant:	IC/Ext
	Pressure max [bar]:	100
	Please note:	Combi bearing; dryrun possible

Part-#	Name
--------	------

8 010 56 066



Axial drilling and milling head HT 4 IC

Weight [kg]:	2.930
Tool drive:	Flat (~DIN 1809)
Shank size [mm]:	55.00
Shank type:	BMT
Tool adaption:	HT 4
Gear ratio [i]:	1:1
Torque max [Nm]:	50
Rotation max [1/min]:	6000
Rotating direction:	same
Coolant:	IC/Ext
Pressure max [bar]:	25
Please note:	Combi bearing

8 010 56 069

Axial drilling and milling head Weldon 20

Weight [kg]:	3.200
Tool drive:	Flat (~DIN 1809)
Shank size [mm]:	55.00
Shank type:	BMT
Tool adaption:	Weldon (DIN 1835 b) 20
Gear ratio [i]:	1:1
Torque max [Nm]:	50
Rotation max [1/min]:	6000
Rotating direction:	same
Coolant:	EXT
Please note:	Combi bearing

8 010 56 110

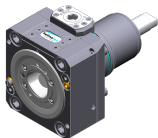

Axial drilling and milling head C 4

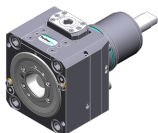

Weight [kg]:	4.750
Notation:	180° reversible
Tool drive:	Flat (~DIN 1809)
Shank size [mm]:	55.00
Shank type:	BMT
Tool adaption:	heimatec Capto(TM) C 4
Gear ratio [i]:	1:1
Torque max [Nm]:	50
Rotation max [1/min]:	6000
Rotating direction:	same
Coolant:	EXT
Please note:	Check applicability; tool length check !

8 010 56 111





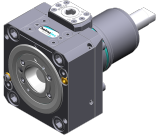

Axial drilling and milling head C 4 IC

Weight [kg]:	5.800
Notation:	180° reversible
Tool drive:	Flat (~DIN 1809)
Shank size [mm]:	55.00
Shank type:	BMT
Machine adaption:	Centering key b 20
Tool adaption:	heimatec Capto(TM) C 4
Gear ratio [i]:	1:1
Torque max [Nm]:	50
Rotation max [1/min]:	6000
Rotating direction:	same
Coolant:	IC/Ext
Pressure max [bar]:	100
Please note:	Check applicability; tool length check !

Part-#	Name	
8 010 56 120	Axial drilling and milling head C 4 IC	
	Notation:	180° reversible
	Tool drive:	Flat (~DIN 1809)
	Shank size [mm]:	55.00
	Shank type:	BMT
	Machine adaption:	Centering key b 20
	Tool adaption:	heimatec Capto(TM) C 4
	Gear ratio [i]:	1:1
	Torque max [Nm]:	50
	Rotation max [1/min]:	6000
	Rotating direction:	same
	Coolant:	IC/Ext
	Pressure max [bar]:	25
	Please note:	Check applicability; tool length check !
8 010 56 138	Axial drilling and milling head C 4	
	Weight [kg]:	4.730
	Notation:	180° reversible
	Tool drive:	Flat (~DIN 1809)
	Shank size [mm]:	55.00
	Shank type:	BMT
	Tool adaption:	heimatec Capto(TM) C 4
	Gear ratio [i]:	1:1
	Torque max [Nm]:	50
	Rotation max [1/min]:	12000
	Rotating direction:	same
	Coolant:	EXT
	Please note:	Check applicability; tool length check !
8 010 56 140	Axial drilling and milling head ER 32 AX UT IC	
	Weight [kg]:	3.000
	Tool drive:	Flat (~DIN 1809)
	Shank size [mm]:	55.00
	Shank type:	BMT
	Tool adaption:	ER 32 A - u-tec
	Gear ratio [i]:	1:1
	Torque max [Nm]:	50
	Rotation max [1/min]:	6000
	Rotating direction:	same
	Coolant:	IC/Ext
	Pressure max [bar]:	100
8 010 56 144	Axial drilling and milling head HT 4 IC	
	Tool drive:	Flat (~DIN 1809)
	Shank size [mm]:	55.00
	Shank type:	BMT
	Tool adaption:	HT 4
	Gear ratio [i]:	1:1
	Torque max [Nm]:	50
	Rotation max [1/min]:	6000
	Rotating direction:	same
	Coolant:	IC/Ext
	Pressure max [bar]:	100



Part-#	Name	
8 010 56 151	Axial drilling and milling head ER 32 AX UT	
	Weight [kg]:	2.770
	Tool drive:	Flat (~DIN 1809)
	Shank size [mm]:	55.00
	Shank type:	BMT
	Tool adaption:	ER 32 A - u-tec
	Gear ratio [i]:	1:1
	Torque max [Nm]:	50
	Rotation max [1/min]:	12000
	Rotating direction:	same
	Coolant:	EXT
8 010 56 153	Axial drilling and milling head ER 32 AX UT IC	
	Weight [kg]:	3.180
	Tool drive:	Flat (~DIN 1809)
	Shank size [mm]:	55.00
	Shank type:	BMT
	Tool adaption:	ER 32 A - u-tec
	Gear ratio [i]:	1:1
	Torque max [Nm]:	50
	Rotation max [1/min]:	15000
	Rotating direction:	same
	Coolant:	IC/Ext
	Pressure max [bar]:	100
8 010 57 065	Axial drilling and milling head Weldon 25 IC	
	Weight [kg]:	3.250
	Tool drive:	Flat (~DIN 1809)
	Shank size [mm]:	55.00
	Shank type:	BMT
	Tool adaption:	Weldon (DIN 1835 b) 25
	Gear ratio [i]:	1:1
	Torque max [Nm]:	50
	Rotation max [1/min]:	6000
	Rotating direction:	same
	Coolant:	IC/Ext
	Pressure max [bar]:	25
	Please note:	Combi bearing
8 010 57 066	Axial drilling and milling head Weldon 25	
	Weight [kg]:	3.230
	Version:	long; special
	Tool drive:	Flat (~DIN 1809)
	Shank size [mm]:	55.00
	Shank type:	BMT
	Tool adaption:	Weldon (DIN 1835 b) 25
	Gear ratio [i]:	1:1
	Torque max [Nm]:	50
	Rotation max [1/min]:	6000
	Rotating direction:	same
	Coolant:	EXT
	Please note:	Combi bearing

Part-#	Name	
8 011 54 006	Axial milling head universal arbor 3/4"	
	Weight [kg]:	2.910
	Tool drive:	Flat (~DIN 1809)
	Shank size [mm]:	55.00
	Shank type:	BMT
	Tool adaption:	Universal arbor 3/4" (19,05mm)
	Gear ratio [i]:	1:1
	Torque max [Nm]:	50
	Rotation max [1/min]:	6000
	Rotating direction:	same
	Coolant:	EXT
	Please note:	Combi bearing
8 011 54 015	Axial milling head arbor 5/8"	
	Weight [kg]:	2.880
	Tool drive:	Flat (~DIN 1809)
	Shank size [mm]:	55.00
	Shank type:	BMT
	Tool adaption:	Arbor 5/8" (15,875mm)
	Gear ratio [i]:	1:1
	Torque max [Nm]:	50
	Rotation max [1/min]:	6000
	Rotating direction:	same
	Coolant:	EXT
	Please note:	Combi bearing
8 011 55 014	Axial milling head universal arbor 22 IC	
	Weight [kg]:	3.080
	Tool drive:	Flat (~DIN 1809)
	Shank size [mm]:	55.00
	Shank type:	BMT
	Tool adaption:	Universal arbor 22
	Gear ratio [i]:	1:1
	Torque max [Nm]:	50
	Rotation max [1/min]:	6000
	Rotating direction:	same
	Coolant:	IC/Ext
	Pressure max [bar]:	100
	Please note:	Combi bearing, Trockenauf possible
8 011 55 015	Axial milling head universal arbor 22	
	Weight [kg]:	3.000
	Tool drive:	Flat (~DIN 1809)
	Shank size [mm]:	55.00
	Shank type:	BMT
	Tool adaption:	Universal arbor 22
	Gear ratio [i]:	1:1
	Torque max [Nm]:	50
	Rotation max [1/min]:	6000
	Rotating direction:	same
	Coolant:	EXT
	Please note:	Combi bearing

Part-#	Name		
	8 019 51 002	Axial drilling and milling head CHC	
		Weight [kg]:	6.880
		Notation:	IC-300
		Version:	no Splash-protection
		Tool drive:	Flat (~DIN 1809)
		Shank size [mm]:	55.00
		Shank type:	BMT
		Tool adaption:	CHC
		Gear ratio [i]:	1:1,5
		Rotation max [1/min]:	18000
		Rotating direction:	same
		Coolant:	no
		Center distance [mm]:	77
	8 019 53 004	Axial drilling and milling head ER 11 AX IC	
		Weight [kg]:	9.380
		Notation:	180° reversible
		Version:	Special
		Tool drive:	Flat (~DIN 1809)
		Shank size [mm]:	55.00
		Shank type:	BMT
		Tool adaption:	ER 11 A
		Gear ratio [i]:	1:3
		Torque max [Nm]:	12
		Rotation max [1/min]:	12000
		Rotating direction:	opposite
		Coolant:	IC/Ext
		Pressure max [bar]:	140
		Center distance [mm]:	90
	Offset [mm]:	134	
	8 019 54 000	Axial drilling and milling head ER 20	
		Notation:	offset
		Tool drive:	Flat (~DIN 1809)
		Shank size [mm]:	55.00
		Shank type:	BMT
		Tool adaption:	ER 20
		Gear ratio [i]:	1:3
		Torque max [Nm]:	10
		Rotation max [1/min]:	12000
		Rotating direction:	opposite
		Coolant:	EXT
	Please note:	180° reversible	
	Offset [mm]:	42	
	8 019 54 021	Axial drilling and milling head ER 20 AX UT	
		Weight [kg]:	5.420
		Notation:	offset; 180° reversible
		Tool drive:	Flat (~DIN 1809)
		Shank size [mm]:	55.00
		Shank type:	BMT
		Tool adaption:	ER 20 A - u-tec
		Gear ratio [i]:	1:1
		Torque max [Nm]:	32
		Rotation max [1/min]:	6000
		Rotating direction:	same
		Coolant:	EXT
	Please note:	stronger bearing	

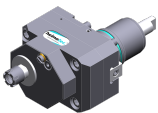
Part-#	Name	
	Offset [mm]:	75
8 019 54 028	Axial drilling and milling head ER 20 AX UT IC	
	Notation:	offset; 180° reversible
	Tool drive:	Flat (~DIN 1809)
	Shank size [mm]:	55.00
	Shank type:	BMT
	Tool adaption:	ER 20 A - u-tec
	Gear ratio [i]:	1:1
	Torque max [Nm]:	32
	Rotation max [1/min]:	6000
	Rotating direction:	same
	Coolant:	IC/Ext
	Pressure max [bar]:	140
	Please note:	stronger bearing
	Offset [mm]:	75
8 019 54 029	Axial milling head universal arbor 16	
	Notation:	offset, 180° reversible
	Tool drive:	Flat (~DIN 1809)
	Shank size [mm]:	55.00
	Shank type:	BMT
	Tool adaption:	Universal arbor 16
	Gear ratio [i]:	2:1
	Torque max [Nm]:	50
	Rotation max [1/min]:	3000
	Rotating direction:	same
	Coolant:	EXT
	Please note:	Combi bearing
	Offset [mm]:	42
8 019 54 031	Axial drilling and milling head ER 20 AX UT	
	Weight [kg]:	5.230
	Notation:	offset; 180° reversible
	Tool drive:	Flat (~DIN 1809)
	Shank size [mm]:	55.00
	Shank type:	BMT
	Tool adaption:	ER 20 A - u-tec
	Gear ratio [i]:	1:3
	Torque max [Nm]:	16
	Rotation max [1/min]:	18000
	Rotating direction:	opposite
	Coolant:	EXT
	Offset [mm]:	42
8 019 54 055	Axial drilling and milling head ER 16 M IC	
	Weight [kg]:	6.200
	Notation:	offset; 180° reversible
	Tool drive:	Flat (~DIN 1809)
	Shank size [mm]:	55.00
	Shank type:	BMT
	Tool adaption:	ER 16 M
	Gear ratio [i]:	1:2
	Torque max [Nm]:	25
	Rotation max [1/min]:	12000
	Rotating direction:	opposite
	Coolant:	IC/Ext

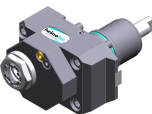

Part-#	Name	
	Pressure max [bar]:	140
	Please note:	stronger bearing
	Offset [mm]:	42
8 019 55 007	Axial milling head arbor 22	
	Notation:	offset
	Version:	Y-axes offset
	Tool drive:	Flat (~DIN 1809)
	Shank size [mm]:	55.00
	Shank type:	BMT
	Tool adaption:	Arbor 22
	Gear ratio [i]:	2:1
	Torque max [Nm]:	40
	Rotation max [1/min]:	3000
	Rotating direction:	opposite
	Coolant:	EXT
	Please note:	stronger bearing
	Offset [mm]:	34,5
8 019 55 018	Axial drilling and milling head ER 25 AX UT	
	Weight [kg]:	5.230
	Notation:	offset; 180° reversible
	Tool drive:	Flat (~DIN 1809)
	Shank size [mm]:	55.00
	Shank type:	BMT
	Tool adaption:	ER 25 A - u-tec
	Gear ratio [i]:	1:1
	Torque max [Nm]:	40
	Rotation max [1/min]:	6000
	Rotating direction:	opposite
	Coolant:	EXT
	Please note:	stronger bearing
	Offset [mm]:	42
8 019 55 023	Axial drilling and milling head ER 25 AX UT IC	
	Weight [kg]:	6.260
	Notation:	offset; 180° reversible
	Tool drive:	Flat (~DIN 1809)
	Shank size [mm]:	55.00
	Shank type:	BMT
	Tool adaption:	ER 25 A - u-tec
	Gear ratio [i]:	1:1
	Torque max [Nm]:	40
	Rotation max [1/min]:	6000
	Rotating direction:	opposite
	Coolant:	IC/Ext
	Pressure max [bar]:	140
	Please note:	stronger bearing
	Offset [mm]:	42
8 019 55 024	Axial drilling and milling head ER 25 AX UT	
	Weight [kg]:	5.230
	Notation:	offset; 180° reversible
	Tool drive:	Flat (~DIN 1809)
	Shank size [mm]:	55.00
	Shank type:	BMT
	Tool adaption:	ER 25 A - u-tec

Part-#	Name
--------	------

Gear ratio [i]:	1:2
Torque max [Nm]:	25
Rotation max [1/min]:	12000
Rotating direction:	opposite
Coolant:	EXT
Please note:	stronger bearing
Offset [mm]:	42

8 019 55 025

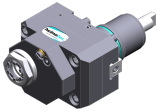

Axial drilling and milling head ER 25 AX UT IC

Weight [kg]:	6.330
Notation:	offset; 180° reversible
Tool drive:	Flat (~DIN 1809)
Shank size [mm]:	55.00
Shank type:	BMT
Tool adaption:	ER 25 A - u-tec
Gear ratio [i]:	1:2
Torque max [Nm]:	25
Rotation max [1/min]:	12000
Rotating direction:	opposite
Coolant:	IC/Ext
Pressure max [bar]:	140
Please note:	stronger bearing
Offset [mm]:	42

8 019 55 026

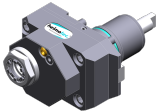

Axial drilling and milling head ER 25 AX UT

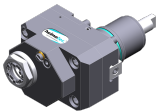

Weight [kg]:	5.300
Notation:	offset; 180° reversible
Tool drive:	Flat (~DIN 1809)
Shank size [mm]:	55.00
Shank type:	BMT
Tool adaption:	ER 25 A - u-tec
Gear ratio [i]:	1:3
Torque max [Nm]:	16
Rotation max [1/min]:	18000
Rotating direction:	opposite
Coolant:	EXT
Please note:	stronger bearing
Offset [mm]:	42

8 019 55 027



Axial drilling and milling head ER 25 AX UT IC

Weight [kg]:	6.350
Notation:	offset; 180° reversible
Tool drive:	Flat (~DIN 1809)
Shank size [mm]:	55.00
Shank type:	BMT
Tool adaption:	ER 25 A - u-tec
Gear ratio [i]:	1:3
Torque max [Nm]:	16
Rotation max [1/min]:	18000
Rotating direction:	opposite
Coolant:	IC/Ext
Pressure max [bar]:	140
Please note:	stronger bearing
Offset [mm]:	42

Part-#	Name	
8 019 55 028	Axial drilling and milling head ER 25 AX UT	
	Weight [kg]:	5.240
	Notation:	offset; 180° reversible
	Tool drive:	Flat (~DIN 1809)
	Shank size [mm]:	55.00
	Shank type:	BMT
	Tool adaption:	ER 25 A - u-tec
	Gear ratio [i]:	2:1
	Torque max [Nm]:	50
	Rotation max [1/min]:	3000
	Rotating direction:	opposite
	Coolant:	EXT
	Please note:	stronger bearing
	Offset [mm]:	42
8 019 55 029	Axial drilling and milling head ER 25 AX UT IC	
	Weight [kg]:	6.220
	Notation:	offset; 180° reversible
	Tool drive:	Flat (~DIN 1809)
	Shank size [mm]:	55.00
	Shank type:	BMT
	Tool adaption:	ER 25 A - u-tec
	Gear ratio [i]:	2:1
	Torque max [Nm]:	50
	Rotation max [1/min]:	3000
	Rotating direction:	opposite
	Coolant:	IC/Ext
	Pressure max [bar]:	140
	Please note:	stronger bearing
	Offset [mm]:	42
8 019 55 045	Axial drilling and milling head ER 25 AX UT IC	
	Weight [kg]:	6.350
	Notation:	offset; 180° reversible
	Version:	Special
	Tool drive:	Flat (~DIN 1809)
	Shank size [mm]:	55.00
	Shank type:	BMT
	Tool adaption:	ER 25 A - u-tec
	Gear ratio [i]:	1:3
	Torque max [Nm]:	16
	Rotation max [1/min]:	18000
	Rotating direction:	opposite
	Coolant:	IC/Ext
	Pressure max [bar]:	140
	Offset [mm]:	42
8 019 55 087	Axial milling head universal arbor 22	
	Weight [kg]:	5.480
	Notation:	offset, 180° reversible
	Tool drive:	Flat (~DIN 1809)
	Shank size [mm]:	55.00
	Shank type:	BMT
	Tool adaption:	Universal arbor 22
	Gear ratio [i]:	2:1
	Torque max [Nm]:	50
	Rotation max [1/min]:	3000

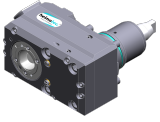
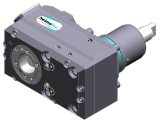
Part-#	Name	
	Rotating direction:	opposite
	Coolant:	EXT
	Please note:	Combi bearing
	Offset [mm]:	42
8 019 56 038	Axial drilling and milling head C 4	
	Weight [kg]:	6.930
	Notation:	180° reversible
	Tool drive:	Flat (~DIN 1809)
	Shank size [mm]:	55.00
	Shank type:	BMT
	Tool adaption:	heimatec Capto(TM) C 4
	Gear ratio [i]:	1:1
	Torque max [Nm]:	50
	Rotation max [1/min]:	6000
	Rotating direction:	opposite
	Coolant:	EXT
	Please note:	Check applicability; note tool length!
	Offset [mm]:	62
8 019 56 042	Axial drilling and milling head C 4 IC	
	Weight [kg]:	7.720
	Notation:	180° reversible
	Tool drive:	Flat (~DIN 1809)
	Shank size [mm]:	55.00
	Shank type:	BMT
	Tool adaption:	heimatec Capto(TM) C 4
	Gear ratio [i]:	1:1
	Torque max [Nm]:	50
	Rotation max [1/min]:	6000
	Rotating direction:	opposite
	Coolant:	IC/Ext
	Pressure max [bar]:	140
	Please note:	Check applicability; note tool length!
	Offset [mm]:	62
8 019 56 057	Axial drilling and milling head C 4 IC	
	Weight [kg]:	7.650
	Notation:	180° reversible
	Tool drive:	Flat (~DIN 1809)
	Shank size [mm]:	55.00
	Shank type:	BMT
	Tool adaption:	heimatec Capto(TM) C 4
	Gear ratio [i]:	1:1
	Torque max [Nm]:	50
	Rotation max [1/min]:	12000
	Rotating direction:	opposite
	Coolant:	IC/Ext
	Pressure max [bar]:	140
	Please note:	Check applicability; note tool length!
	Offset [mm]:	62

Part-#	Name
--------	------

8 030 54 048	Radial drilling and milling head ER 16 AX UT
Weight [kg]:	6.320
Notation:	180° reversible
Tool drive:	Flat (~DIN 1809)
Shank size [mm]:	55.00
Shank type:	BMT
Tool adaption:	ER 16 A - u-tec
Gear ratio [i]:	1:3
Torque max [Nm]:	12
Rotation max [1/min]:	18000
Rotating direction:	same
Coolant:	EXT
Please note:	stronger bearing
Center distance [mm]:	77

8 030 54 049	Radial drilling and milling head ER 16 AX UT IC
Weight [kg]:	6.500
Notation:	180° reversible
Tool drive:	Flat (~DIN 1809)
Shank size [mm]:	55.00
Shank type:	BMT
Tool adaption:	ER 16 A - u-tec
Gear ratio [i]:	1:1
Torque max [Nm]:	50
Rotation max [1/min]:	6000
Rotating direction:	opposite
Coolant:	IC/Ext
Pressure max [bar]:	140
Please note:	Combi bearing; high pressure version
Center distance [mm]:	65



8 030 54 050	Radial drilling and milling head ER 16 AX UT IC
Notation:	180° reversible
Tool drive:	Flat (~DIN 1809)
Shank size [mm]:	55.00
Shank type:	BMT
Tool adaption:	ER 16 A - u-tec
Gear ratio [i]:	1:4
Torque max [Nm]:	5
Rotation max [1/min]:	24000
Rotating direction:	opposite
Coolant:	IC/Ext
Pressure max [bar]:	140
Center distance [mm]:	65



8 030 54 064	Radial drilling and milling head ER 20 AX UT IC
Weight [kg]:	6.520
Notation:	180° reversible
Tool drive:	Flat (~DIN 1809)
Shank size [mm]:	55.00
Shank type:	BMT
Tool adaption:	ER 20 A - u-tec
Gear ratio [i]:	1:2
Torque max [Nm]:	16
Rotation max [1/min]:	12000
Rotating direction:	same
Coolant:	IC/Ext

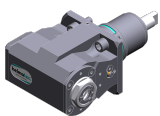

Part-#	Name
--------	------

Pressure max [bar]: 140
Please note: stronger bearing
Center distance [mm]: 77

8 030 55 004 Radial drilling and milling head ER 25 IC



Weight [kg]: 5.200
Tool drive: Flat (~DIN 1809)
Shank size [mm]: 55.00
Shank type: BMT
Tool adaption: ER 25
Gear ratio [i]: 1:1
Torque max [Nm]: 25
Rotation max [1/min]: 6000
Rotating direction: opposite
Coolant: IC/Ext
Pressure max [bar]: 140
Center distance [mm]: 55

8 030 55 063 Radial drilling and milling head ER 25 AX UT



Notation: 180° reversible
Tool drive: Flat (~DIN 1809)
Shank size [mm]: 55.00
Shank type: BMT
Tool adaption: ER 25 A - u-tec
Gear ratio [i]: 2:1
Torque max [Nm]: 63
Rotation max [1/min]: 6000
Rotating direction: opposite
Coolant: EXT
Please note: Combi bearing
Center distance [mm]: 65

8 030 55 087 Radial drilling and milling head Weldon 3/4"





Weight [kg]: 6.690
Notation: 180° reversible
Tool drive: Flat (~DIN 1809)
Shank size [mm]: 55.00
Shank type: BMT
Tool adaption: Weldon (DIN 1835 b) 3/4" (19,05mm)
Gear ratio [i]: 1:1
Torque max [Nm]: 50
Rotation max [1/min]: 6000
Rotating direction: opposite
Coolant: EXT
Please note: Combi bearing
Center distance [mm]: 65



8 030 55 091 Angle-mill- and drill holder ER 25 AX UT IC

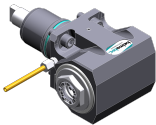
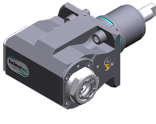

Weight [kg]: 6.680
Notation: 180° reversible
Tool drive: Flat (~DIN 1809)
Shank size [mm]: 55.00
Shank type: BMT
Tool adaption: ER 25 A - u-tec
Gear ratio [i]: 1:1
Torque max [Nm]: 50

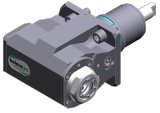
Part-#	Name	
		Rotation max [1/min]: 6000 Rotating direction: opposite Coolant: IC/Ext Pressure max [bar]: 140 Please note: Combi bearing; high pressure version Center distance [mm]: 65
8 030 55 092	Angle-mill- and drill holder ER 25 AX UT	
		Weight [kg]: 6.320 Notation: 180° reversible Tool drive: Flat (~DIN 1809) Shank size [mm]: 55.00 Shank type: BMT Tool adaption: ER 25 A - u-tec Gear ratio [i]: 1:1 Torque max [Nm]: 50 Rotation max [1/min]: 6000 Rotating direction: opposite Coolant: EXT Please note: Combi bearing Center distance [mm]: 65
8 030 55 122	Radial drilling and milling head ER 25 AX UT	
		Weight [kg]: 6.380 Notation: 180° reversible Tool drive: Flat (~DIN 1809) Shank size [mm]: 55.00 Shank type: BMT Tool adaption: ER 25 A - u-tec Gear ratio [i]: 1:2 Torque max [Nm]: 16 Rotation max [1/min]: 12000 Rotating direction: same Coolant: EXT Please note: stronger bearing; check applicability; Center distance [mm]: 77
8 030 55 123	Radial drilling and milling head ER 25 AX UT IC	
		Weight [kg]: 6.550 Notation: 180° reversible Tool drive: Flat (~DIN 1809) Shank size [mm]: 55.00 Shank type: BMT Tool adaption: ER 25 A - u-tec Gear ratio [i]: 1:2 Torque max [Nm]: 16 Rotation max [1/min]: 12000 Rotating direction: same Coolant: IC/Ext Pressure max [bar]: 140 Please note: stronger bearing Center distance [mm]: 77

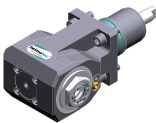
Part-#	Name
8 030 55 139	Radial drilling and milling head ER 25 AX UT IC
	Weight [kg]: 6.560 Notation: 180° reversible Tool drive: Flat (~DIN 1809) Shank size [mm]: 55.00 Shank type: BMT Tool adaption: ER 25 A - u-tec Gear ratio [i]: 1:3 Torque max [Nm]: 12 Rotation max [1/min]: 18000 Rotating direction: same Coolant: IC/Ext Pressure max [bar]: 140 Please note: stronger bearing Center distance [mm]: 77
8 030 55 140	Radial drilling and milling head ER 25 AX UT
	Weight [kg]: 6.700 Notation: 180° reversible Tool drive: Flat (~DIN 1809) Shank size [mm]: 55.00 Shank type: BMT Tool adaption: ER 25 A - u-tec Gear ratio [i]: 1:3 Torque max [Nm]: 12 Rotation max [1/min]: 18000 Rotating direction: same Coolant: EXT Please note: stronger bearing Center distance [mm]: 77
8 030 55 158	Radial drilling and milling head C 3 IC
	Weight [kg]: 8.280 Notation: 180° reversible Tool drive: Flat (~DIN 1809) Shank size [mm]: 55.00 Shank type: BMT Tool adaption: heimatec Capto(TM) C 3 Gear ratio [i]: 1:1 Torque max [Nm]: 25 Rotation max [1/min]: 8000 Rotating direction: opposite Coolant: IC/Ext Pressure max [bar]: 140 Please note: Check applicability; note tool length! Center distance [mm]: 65
8 030 55 159	Radial drilling and milling head ER 25 AX UT
	Weight [kg]: 7.710 Notation: 180° reversible Tool drive: Flat (~DIN 1809) Shank size [mm]: 55.00 Shank type: BMT Tool adaption: ER 25 A - u-tec Gear ratio [i]: 1:3 Torque max [Nm]: 12 Rotation max [1/min]: 18000 Rotating direction: same

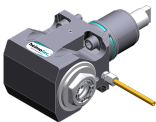
Part-#	Name	
	Coolant:	EXT
	Please note:	stronger bearing
	Center distance [mm]:	107
8 030 55 206	Radial drilling and milling head ER 25 AX UT IC	
	Notation:	180° reversible
	Tool drive:	Flat (~DIN 1809)
	Shank size [mm]:	55.00
	Shank type:	BMT
	Tool adaption:	ER 25 A - u-tec
	Gear ratio [i]:	1:2
	Torque max [Nm]:	16
	Rotation max [1/min]:	12000
	Rotating direction:	same
	Coolant:	IC/Ext
	Pressure max [bar]:	140
	Please note:	strong bearing with hybrid-bearing
	Center distance [mm]:	77
8 030 55 216	Angle-mill- and drill holder ER 25 AX UT	
	Notation:	180° reversible
	Tool drive:	Flat (~DIN 1809)
	Shank size [mm]:	55.00
	Shank type:	BMT
	Tool adaption:	ER 25 A - u-tec
	Gear ratio [i]:	1:1
	Torque max [Nm]:	50
	Rotation max [1/min]:	6000
	Rotating direction:	opposite
	Coolant:	EXT
	Please note:	Combi bearing; check applicability
	Center distance [mm]:	95
8 030 55 217	Angle-mill- and drill holder ER 25 AX UT IC	
	Notation:	180° reversible
	Tool drive:	Flat (~DIN 1809)
	Shank size [mm]:	55.00
	Shank type:	BMT
	Tool adaption:	ER 25 A - u-tec
	Gear ratio [i]:	1:1
	Torque max [Nm]:	50
	Rotation max [1/min]:	6000
	Rotating direction:	opposite
	Coolant:	IC/Ext
	Pressure max [bar]:	140
	Please note:	Combi bearing; Einsatzbereit check!
	Center distance [mm]:	95
8 030 55 238	Radial drilling and milling head ER 25 AX UT	
	Weight [kg]:	6.100
	Notation:	180° reversible
	Tool drive:	Flat (~DIN 1809)
	Shank size [mm]:	55.00
	Shank type:	BMT
	Tool adaption:	ER 25 A - u-tec
	Gear ratio [i]:	1:1
	Torque max [Nm]:	50

Part-#	Name
--------	------

Rotation max [1/min]: 12000
 Rotating direction: opposite
 Coolant: EXT
 Center distance [mm]: 65

8 030 55 239 Radial drilling and milling head ER 25 AX UT IC

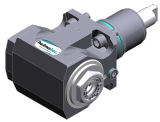

Weight [kg]: 6.470
 Notation: 180° reversible
 Tool drive: Flat (~DIN 1809)
 Shank size [mm]: 55.00
 Shank type: BMT
 Tool adaption: ER 25 A - u-tec
 Gear ratio [i]: 1:1
 Torque max [Nm]: 50
 Rotation max [1/min]: 12000
 Rotating direction: opposite
 Coolant: IC/Ext
 Pressure max [bar]: 140
 Center distance [mm]: 65

8 030 55 240 Radial drilling and milling head ER 25 AX UT

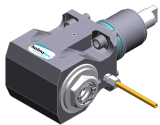

Weight [kg]: 6.380
 Notation: 180° reversible
 Tool drive: Flat (~DIN 1809)
 Shank size [mm]: 55.00
 Shank type: BMT
 Tool adaption: ER 25 A - u-tec
 Gear ratio [i]: 1:1
 Torque max [Nm]: 50
 Rotation max [1/min]: 12000
 Rotating direction: opposite
 Coolant: EXT
 Center distance [mm]: 75

8 030 55 241 Angle drilling and milling head ER 25 AX UT IC

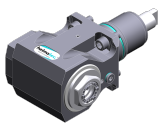

Weight [kg]: 6.960
 Notation: 180° reversible
 Tool drive: Flat (~DIN 1809)
 Shank size [mm]: 55.00
 Shank type: BMT
 Tool adaption: ER 25 A - u-tec
 Gear ratio [i]: 1:1
 Torque max [Nm]: 50
 Rotation max [1/min]: 12000
 Rotating direction: opposite
 Coolant: IC/Ext
 Pressure max [bar]: 140
 Center distance [mm]: 75

8 030 55 244 Angle-mill- and drill holder ER 25 AS UT

Notation: 180° reversible
 Tool drive: Flat (~DIN 1809)
 Shank size [mm]: 55.00
 Shank type: BMT
 Tool adaption: ER 25 A - u-tec
 Gear ratio [i]: 1:1
 Torque max [Nm]: 50

Part-#	Name
--------	------

Rotation max [1/min]:	6000
Rotating direction:	opposite
Coolant:	EXT
Please note:	Combi bearing
Center distance [mm]:	65

8 030 55 246 Radial drilling and milling head ER 25 AS UT

Notation:	180° reversible
Tool drive:	Flat (~DIN 1809)
Shank size [mm]:	55.00
Shank type:	BMT
Tool adaption:	ER 25 A - u-tec
Gear ratio [i]:	1:1
Torque max [Nm]:	50
Rotation max [1/min]:	12000
Rotating direction:	opposite
Coolant:	EXT
Center distance [mm]:	65

8 030 55 247 Radial drilling and milling head ER 25 AS UT IC

Notation:	180° reversible
Tool drive:	Flat (~DIN 1809)
Shank size [mm]:	55.00
Shank type:	BMT
Tool adaption:	ER 25 A - u-tec
Gear ratio [i]:	1:1
Torque max [Nm]:	50
Rotation max [1/min]:	12000
Rotating direction:	opposite
Coolant:	IC/Ext
Pressure max [bar]:	140
Center distance [mm]:	65

8 030 55 250 Radial drilling and milling head ER 25 AX UT IC

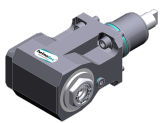

Weight [kg]:	8.170
Notation:	180° reversible
Tool drive:	Flat (~DIN 1809)
Shank size [mm]:	55.00
Shank type:	BMT
Tool adaption:	ER 25 A - u-tec
Gear ratio [i]:	1:1
Torque max [Nm]:	50
Rotation max [1/min]:	12000
Rotating direction:	opposite
Coolant:	IC/Ext
Pressure max [bar]:	140
Please note:	Check applicability; note tool length!
Center distance [mm]:	100

8 030 55 251 Radial drilling and milling head ER 25 AX UT IC

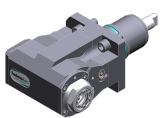

Weight [kg]:	7.520
Notation:	180° reversible
Tool drive:	Flat (~DIN 1809)
Shank size [mm]:	55.00
Shank type:	BMT
Tool adaption:	ER 25 A - u-tec
Gear ratio [i]:	1:2

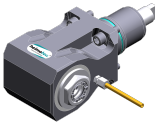
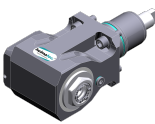
Part-#	Name	
		Torque max [Nm]: 16 Rotation max [1/min]: 16000 Rotating direction: same Coolant: IC/Ext Pressure max [bar]: 140 Please note: stronger bearing; check applicability; Center distance [mm]: 100
8 030 55 262	Radial drilling and milling head ER 25 AX UT	
		Weight [kg]: 7.500 Notation: 180° reversible Tool drive: Flat (~DIN 1809) Shank size [mm]: 55.00 Shank type: BMT Tool adaption: ER 25 A - u-tec Gear ratio [i]: 1:1 Torque max [Nm]: 50 Rotation max [1/min]: 12000 Rotating direction: opposite Coolant: EXT Please note: Check applicability! Center distance [mm]: 95
8 030 55 263	Radial drilling and milling head ER 25 AX UT IC	
		Weight [kg]: 7.980 Notation: 180° reversible Tool drive: Flat (~DIN 1809) Shank size [mm]: 55.00 Shank type: BMT Tool adaption: ER 25 A - u-tec Gear ratio [i]: 1:1 Torque max [Nm]: 50 Rotation max [1/min]: 12000 Rotating direction: opposite Coolant: IC/Ext Pressure max [bar]: 140 Please note: Check applicability! Center distance [mm]: 95
8 030 56 059	Radial drilling and milling head HT 4 IC	
		Notation: 180° reversible Version: long Tool drive: Flat (~DIN 1809) Shank size [mm]: 55.00 Shank type: BMT Tool adaption: HT 4 Gear ratio [i]: 2:1 Torque max [Nm]: 63 Rotation max [1/min]: 3000 Rotating direction: opposite Coolant: IC/Ext Pressure max [bar]: 140 Please note: Combi bearing Center distance [mm]: 65

Part-#	Name
--------	------

8 030 56 070

Radial drilling and milling head ER 32 AX UT

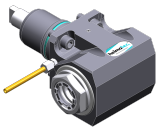

Notation: 180° reversible
 Tool drive: Flat (~DIN 1809)
 Shank size [mm]: 55.00
 Shank type: BMT
 Tool adaption: ER 32 A - u-tec
 Gear ratio [i]: 2:1
 Torque max [Nm]: 63
 Rotation max [1/min]: 6000
 Rotating direction: opposite
 Coolant: EXT
 Please note: Combi bearing
 Center distance [mm]: 65

8 030 56 075

Radial drilling and milling head HT 4 IC

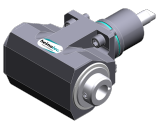

Weight [kg]: 6.580
 Notation: 180° reversible
 Tool drive: Flat (~DIN 1809)
 Shank size [mm]: 55.00
 Shank type: BMT
 Tool adaption: HT 4
 Gear ratio [i]: 1:1
 Torque max [Nm]: 50
 Rotation max [1/min]: 6000
 Rotating direction: opposite
 Coolant: IC/Ext
 Pressure max [bar]: 140
 Please note: Combi bearing
 Center distance [mm]: 65

8 030 56 090

Radial drilling and milling head ER 32 AX UT IC

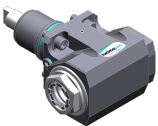

Notation: 180° reversible
 Tool drive: Flat (~DIN 1809)
 Shank size [mm]: 55.00
 Shank type: BMT
 Tool adaption: ER 32 A - u-tec
 Gear ratio [i]: 2:1
 Torque max [Nm]: 63
 Rotation max [1/min]: 6000
 Rotating direction: opposite
 Coolant: IC/Ext
 Pressure max [bar]: 140
 Please note: Combi bearing
 Center distance [mm]: 65

8 030 56 095

Angle-mill- and drill holder ER 32 AX UT

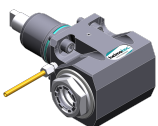

Weight [kg]: 6.320
 Notation: 180° reversible
 Tool drive: Flat (~DIN 1809)
 Shank size [mm]: 55.00
 Shank type: BMT
 Tool adaption: ER 32 A - u-tec
 Gear ratio [i]: 1:1
 Torque max [Nm]: 50
 Rotation max [1/min]: 6000
 Rotating direction: opposite

Part-#	Name	
	Coolant:	EXT
	Please note:	Combi bearing
	Center distance [mm]:	65
8 030 56 096	Angle-mill- and drill holder ER 32 AX UT IC	
	Weight [kg]:	6.700
	Notation:	180° reversible
	Tool drive:	Flat (~DIN 1809)
	Shank size [mm]:	55.00
	Tool adaption:	ER 32 A - u-tec
	Gear ratio [i]:	1:1
	Torque max [Nm]:	50
	Rotation max [1/min]:	6000
	Rotating direction:	opposite
	Coolant:	IC/Ext
	Pressure max [bar]:	140
	Please note:	Combi bearing
	Center distance [mm]:	65
8 030 56 121	Radial drilling and milling head HT 4 IC	
	Notation:	180° reversible
	Tool drive:	Flat (~DIN 1809)
	Shank size [mm]:	55.00
	Shank type:	BMT
	Tool adaption:	HT 4
	Gear ratio [i]:	1:3
	Torque max [Nm]:	12
	Rotation max [1/min]:	18000
	Rotating direction:	same
	Coolant:	IC/Ext
	Pressure max [bar]:	140
	Please note:	stronger bearing
	Center distance [mm]:	77
8 030 56 124	Radial drilling and milling head HT 4	
	Weight [kg]:	6.300
	Notation:	180° reversible
	Tool drive:	Flat (~DIN 1809)
	Shank size [mm]:	55.00
	Shank type:	BMT
	Tool adaption:	HT 4
	Gear ratio [i]:	1:3
	Torque max [Nm]:	12
	Rotation max [1/min]:	18000
	Rotating direction:	same
	Coolant:	EXT
	Please note:	stronger bearing
	Center distance [mm]:	77
8 030 56 125	Radial drilling and milling head HT 4 IC	
	Weight [kg]:	6.520
	Notation:	180° reversible
	Tool drive:	Flat (~DIN 1809)
	Shank size [mm]:	55.00
	Shank type:	BMT
	Tool adaption:	HT 4
	Gear ratio [i]:	1:2

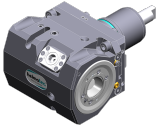
Part-#	Name	
	Torque max [Nm]:	16
	Rotation max [1/min]:	12000
	Rotating direction:	same
	Coolant:	IC/Ext
	Pressure max [bar]:	140
	Please note:	stronger bearing
	Center distance [mm]:	77
8 030 56 126	Radial drilling and milling head HT 4	
	Weight [kg]:	6.340
	Notation:	180° reversible
	Tool drive:	Flat (~DIN 1809)
	Shank size [mm]:	55.00
	Shank type:	BMT
	Tool adaption:	HT 4
	Gear ratio [i]:	1:2
	Torque max [Nm]:	16
	Rotation max [1/min]:	12000
	Rotating direction:	same
	Coolant:	EXT
	Please note:	stronger bearing
	Center distance [mm]:	77
8 030 56 176	Radial drilling and milling head C 4	
	Notation:	180° reversible
	Tool drive:	Flat (~DIN 1809)
	Shank size [mm]:	55.00
	Shank type:	BMT
	Tool adaption:	heimatec Capto(TM) C 4
	Gear ratio [i]:	1:1
	Torque max [Nm]:	40
	Rotation max [1/min]:	6000
	Rotating direction:	opposite
	Coolant:	EXT
	Pressure max [bar]:	140
	Please note:	Check applicability; note tool length!
	Center distance [mm]:	65
8 030 56 177	Radial drilling and milling head C 4 IC	
	Weight [kg]:	9.780
	Notation:	180° reversible
	Tool drive:	Flat (~DIN 1809)
	Shank size [mm]:	55.00
	Shank type:	BMT
	Tool adaption:	heimatec Capto(TM) C 4
	Gear ratio [i]:	1:1
	Torque max [Nm]:	40
	Rotation max [1/min]:	6000
	Rotating direction:	opposite
	Coolant:	IC/Ext
	Pressure max [bar]:	140
	Please note:	Check applicability; note tool length!
	Center distance [mm]:	65

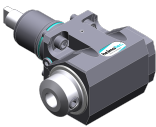
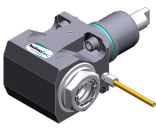
Part-#	Name	
8 030 56 214	Radial drilling and milling head C 4 IC	
	Notation:	180° reversible
	Tool drive:	Flat (~DIN 1809)
	Shank size [mm]:	55.00
	Shank type:	BMT
	Tool adaption:	heimatec Capto(TM) C 4
	Gear ratio [i]:	1:1
	Torque max [Nm]:	63
	Rotation max [1/min]:	12000
	Rotating direction:	opposite
	Coolant:	IC/Ext
	Pressure max [bar]:	140
	Please note:	Check applicability; note tool length!
	Center distance [mm]:	65
8 030 56 215	Radial drilling and milling head C 4	
	Notation:	180° reversible
	Tool drive:	Flat (~DIN 1809)
	Shank size [mm]:	55.00
	Shank type:	BMT
	Tool adaption:	heimatec Capto(TM) C 4
	Gear ratio [i]:	1:1
	Torque max [Nm]:	63
	Rotation max [1/min]:	12000
	Rotating direction:	opposite
	Coolant:	EXT
	Please note:	Check applicability; note tool length!
	Center distance [mm]:	65
8 030 56 216	Radial drilling and milling head Weldon 20 IC	
	Weight [kg]:	7.040
	Notation:	180° reversible
	Tool drive:	Flat (~DIN 1809)
	Shank size [mm]:	55.00
	Shank type:	BMT
	Tool adaption:	Weldon (DIN 1835 b) 20
	Gear ratio [i]:	1:1
	Torque max [Nm]:	50
	Rotation max [1/min]:	12000
	Rotating direction:	opposite
	Coolant:	IC/Ext
	Pressure max [bar]:	140
	Please note:	stronger bearing; high pressure version
	Center distance [mm]:	65
8 030 56 235	Radial drilling and milling head ER 32 AX UT	
	Weight [kg]:	6.050
	Notation:	180° reversible
	Tool drive:	Flat (~DIN 1809)
	Shank size [mm]:	55.00
	Shank type:	BMT
	Tool adaption:	ER 32 A - u-tec
	Gear ratio [i]:	1:1
	Torque max [Nm]:	50
	Rotation max [1/min]:	12000
	Rotating direction:	opposite
	Coolant:	EXT

Part-#	Name
--------	------

Center distance [mm]: 65

8 030 56 236

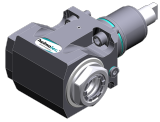

Radial drilling and milling head ER 32 AX UT IC
 Weight [kg]: 5.830
 Notation: 180° reversible
 Tool drive: Flat (~DIN 1809)
 Shank size [mm]: 55.00
 Shank type: BMT
 Tool adaption: ER 32 A - u-tec
 Gear ratio [i]: 1:1
 Torque max [Nm]: 50
 Rotation max [1/min]: 12000
 Rotating direction: opposite
 Coolant: IC/Ext
 Pressure max [bar]: 140
 Center distance [mm]: 65

8 030 56 237

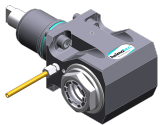

Radial drilling and milling head ER 32 AX UT
 Weight [kg]: 6.500
 Notation: 180° reversible
 Tool drive: Flat (~DIN 1809)
 Shank size [mm]: 55.00
 Shank type: BMT
 Tool adaption: ER 32 A - u-tec
 Gear ratio [i]: 1:1
 Torque max [Nm]: 50
 Rotation max [1/min]: 12000
 Rotating direction: opposite
 Coolant: EXT
 Center distance [mm]: 75

8 030 56 238



Radial drilling and milling head ER 32 AX UT IC
 Weight [kg]: 7.200
 Notation: 180° reversible
 Tool drive: Flat (~DIN 1809)
 Shank size [mm]: 55.00
 Shank type: BMT
 Tool adaption: ER 32 A - u-tec
 Gear ratio [i]: 1:1
 Torque max [Nm]: 50
 Rotation max [1/min]: 12000
 Rotating direction: opposite
 Coolant: IC/Ext
 Pressure max [bar]: 140
 Center distance [mm]: 75

8 030 56 239

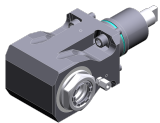

Radial drilling and milling head ER 32 AX UT
 Weight [kg]: 7.500
 Notation: 180° reversible
 Tool drive: Flat (~DIN 1809)
 Shank size [mm]: 55.00
 Shank type: BMT
 Tool adaption: ER 32 A - u-tec
 Gear ratio [i]: 1:1
 Torque max [Nm]: 50
 Rotation max [1/min]: 12000

Part-#	Name
--------	------

Rotating direction: opposite
Coolant: EXT
Please note: Check applicability!
Center distance [mm]: 95

8 030 56 240 Radial drilling and milling head ER 32 AX UT IC

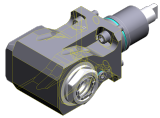

Weight [kg]: 7.960
Notation: 180° reversible
Tool drive: Flat (~DIN 1809)
Shank size [mm]: 55.00
Shank type: BMT
Tool adaption: ER 32 A - u-tec
Gear ratio [i]: 1:1
Torque max [Nm]: 50
Rotation max [1/min]: 12000
Rotating direction: opposite
Coolant: IC/Ext
Pressure max [bar]: 140
Please note: Check applicability!
Center distance [mm]: 95

8 030 56 249 Radial drilling and milling head HT 4 IC

Weight [kg]: 6.580
Notation: 180° reversible
Tool drive: Flat (~DIN 1809)
Shank size [mm]: 55.00
Shank type: BMT
Tool adaption: HT 4
Gear ratio [i]: 1:1
Torque max [Nm]: 50
Rotation max [1/min]: 12000
Rotating direction: opposite
Coolant: IC/Ext
Pressure max [bar]: 140
Center distance [mm]: 65

8 030 56 271 Radial drilling and milling head ER 32 AX UT

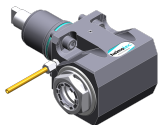

Weight [kg]: 6.380
Notation: 180° reversible
Tool drive: Flat (~DIN 1809)
Shank size [mm]: 55.00
Shank type: BMT
Tool adaption: ER 32 A - u-tec
Gear ratio [i]: 1:1
Torque max [Nm]: 50
Rotation max [1/min]: 12000
Rotating direction: opposite
Coolant: EXT
Pressure max [bar]: 140
Please note: stronger bearing
Center distance [mm]: 65

Part-#	Name
--------	------

8 030 56 275



Radial drilling and milling head ER 32 AX UT IC
 Weight [kg]: 6.700
 Notation: 180° reversible
 Tool drive: Flat (~DIN 1809)
 Shank size [mm]: 55.00
 Shank type: BMT
 Tool adaption: ER 32 A - u-tec
 Gear ratio [i]: 1:1
 Torque max [Nm]: 50
 Rotation max [1/min]: 12000
 Rotating direction: opposite
 Coolant: IC/Ext
 Pressure max [bar]: 140
 Please note: stronger bearing
 Center distance [mm]: 65

8 030 57 044

Radial drilling and milling head Weldon 25 IC
 Weight [kg]: 7.150
 Notation: 180° reversible
 Tool drive: Flat (~DIN 1809)
 Shank size [mm]: 55.00
 Shank type: BMT
 Tool adaption: Weldon (DIN 1835 b) 25
 Gear ratio [i]: 1:1
 Torque max [Nm]: 50
 Rotation max [1/min]: 6000
 Rotating direction: opposite
 Coolant: IC/Ext
 Pressure max [bar]: 140
 Please note: Combi bearing
 Center distance [mm]: 65



8 030 57 120

Radial drilling and milling head ER 40 AX UT
 Notation: 180° reversible
 Tool drive: Flat (~DIN 1809)
 Shank size [mm]: 55.00
 Shank type: BMT
 Tool adaption: ER 40 A - u-tec
 Gear ratio [i]: 1:1
 Torque max [Nm]: 50
 Rotation max [1/min]: 6000
 Rotating direction: opposite
 Coolant: EXT
 Please note: stronger bearing
 Center distance [mm]: 65

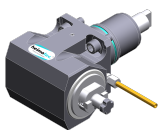
8 031 54 014



Radial milling head universal arbor 16
 Weight [kg]: 6.500
 Notation: 180° reversible
 Tool drive: Flat (~DIN 1809)
 Shank size [mm]: 55.00
 Shank type: BMT
 Tool adaption: Universal arbor 16
 Gear ratio [i]: 1:1
 Torque max [Nm]: 50
 Rotation max [1/min]: 6000
 Rotating direction: opposite

Part-#	Name	
	Coolant:	EXT
	Please note:	Combi bearing
	Center distance [mm]:	65
8 031 54 015	Radial polygon head arbor 16	
	Weight [kg]:	6.650
	Notation:	180° reversible
	Tool drive:	Flat (~DIN 1809)
	Shank size [mm]:	55.00
	Shank type:	BMT
	Tool adaption:	Polygon arbor 16
	Gear ratio [i]:	1:1
	Torque max [Nm]:	50
	Rotation max [1/min]:	6000
	Rotating direction:	opposite
	Coolant:	EXT
	Please note:	Combi bearing
	Center distance [mm]:	65
8 031 56 010	Radial polygon head arbor 27	
	Notation:	180° reversible
	Tool drive:	Flat (~DIN 1809)
	Shank size [mm]:	55.00
	Shank type:	BMT
	Tool adaption:	Polygon arbor 27
	Gear ratio [i]:	1:1
	Torque max [Nm]:	50
	Rotation max [1/min]:	6000
	Rotating direction:	opposite
	Coolant:	EXT
	Please note:	Combi bearing
	Center distance [mm]:	65
8 031 56 012	Radial milling head universal arbor 27	
	Weight [kg]:	6.560
	Notation:	180° reversible
	Tool drive:	Flat (~DIN 1809)
	Shank size [mm]:	55.00
	Shank type:	BMT
	Tool adaption:	Universal arbor 27
	Gear ratio [i]:	1:1
	Torque max [Nm]:	50
	Rotation max [1/min]:	6000
	Rotating direction:	opposite
	Coolant:	EXT
	Please note:	Combi bearing
	Center distance [mm]:	65
8 031 56 022	Radial milling head universal arbor 27	
	Notation:	180° reversible
	Tool drive:	Flat (~DIN 1809)
	Shank size [mm]:	55.00
	Shank type:	BMT
	Tool adaption:	Universal arbor 27
	Gear ratio [i]:	2:1
	Torque max [Nm]:	63
	Rotation max [1/min]:	3000

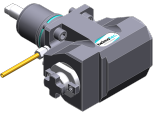
Part-#	Name	
	Rotating direction:	opposite
	Coolant:	EXT
	Please note:	Combi bearing
	Center distance [mm]:	65
8 031 56 026	Radial milling head arbor 27	
	Notation:	180° reversible
	Tool drive:	Flat (~DIN 1809)
	Shank size [mm]:	55.00
	Shank type:	BMT
	Tool adaption:	Arbor 27
	Gear ratio [i]:	2:1
	Torque max [Nm]:	63
	Rotation max [1/min]:	3000
	Rotating direction:	opposite
	Coolant:	EXT
	Please note:	Combi bearing
	Center distance [mm]:	65
8 033 56 020	Radial drilling and milling head ER 32 AX UT IC	
	Weight [kg]:	8.670
	Notation:	offset; 180° reversible
	Tool drive:	Flat (~DIN 1809)
	Shank size [mm]:	55.00
	Shank type:	BMT
	Tool adaption:	ER 32 A - u-tec
	Gear ratio [i]:	1:1
	Torque max [Nm]:	50
	Rotation max [1/min]:	6000
	Rotating direction:	same
	Coolant:	IC/Ext
	Pressure max [bar]:	140
	Please note:	Combi bearing
	Center distance [mm]:	75
8 037 52 002	Radial disk mill head arbor 10	
	Weight [kg]:	6.900
	Tool drive:	Flat (~DIN 1809)
	Shank size [mm]:	55.00
	Shank type:	BMT
	Tool adaption:	Arbor 10
	Gear ratio [i]:	2:1
	Torque max [Nm]:	32
	Rotation max [1/min]:	3000
	Rotating direction:	opposite
	Coolant:	no
	Center distance [mm]:	76
8 037 53 001	Radial disk mill head arbor 13	
	Weight [kg]:	6.960
	Tool drive:	Flat (~DIN 1809)
	Shank size [mm]:	55.00
	Shank type:	BMT
	Tool adaption:	Arbor 13
	Gear ratio [i]:	2:1
	Torque max [Nm]:	32
	Rotation max [1/min]:	3000

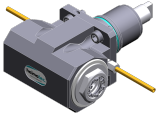
Part-#	Name	
	Rotating direction:	opposite
	Coolant:	no
	Center distance [mm]:	76
8 039 54 029	Radial milling head arbor 16	
	Weight [kg]:	9.600
	Notation:	offset; 180° reversible
	Version:	Special; ±45° turnable
	Tool drive:	Flat (~DIN 1809)
	Shank size [mm]:	55.00
	Shank type:	BMT
	Tool adaption:	Arbor 16
	Gear ratio [i]:	1:1
	Torque max [Nm]:	50
	Rotation max [1/min]:	6000
	Rotating direction:	same
	Coolant:	EXT
	Please note:	stronger bearing
	Center distance [mm]:	91
8 039 54 035	Radial drilling and milling head ER 16 AX UT IC	
	Weight [kg]:	4.980
	Notation:	180° reversible; 35° angle
	Tool drive:	Flat (~DIN 1809)
	Shank size [mm]:	55.00
	Shank type:	BMT
	Tool adaption:	ER 16 A - u-tec
	Gear ratio [i]:	1:1
	Torque max [Nm]:	40
	Rotation max [1/min]:	6000
	Rotating direction:	opposite
	Coolant:	IC/Ext
	Pressure max [bar]:	140
8 039 55 042	Radial drilling and milling head ER 25 AX UT	
	Weight [kg]:	6.480
	Notation:	180° reversible
	Employment for:	Main- and sub spindle
	Version:	double spindle
	Tool drive:	Flat (~DIN 1809)
	Shank size [mm]:	55.00
	Shank type:	BMT
	Tool adaption:	ER 25 A - u-tec
	Gear ratio [i]:	1:1
	Torque max [Nm]:	50
	Rotation max [1/min]:	12000
	Rotating direction:	same/opposite
	Coolant:	EXT
	Please note:	stronger bearing
	Center distance [mm]:	65

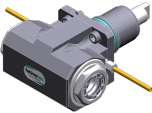
Part-#	Name	
8 039 56 009	Radial drilling and milling head HT 4	
	Weight [kg]:	6.600
	Notation:	180° reversible
	Employment for:	Main- and sub spindle
	Version:	double spindle
	Tool drive:	Flat (~DIN 1809)
	Shank size [mm]:	55.00
	Shank type:	BMT
	Tool adaption:	HT 4
	Gear ratio [i]:	1:1
	Torque max [Nm]:	50
	Rotation max [1/min]:	12000
	Rotating direction:	same/opposite
	Coolant:	EXT
	Please note:	stronger bearing
	Center distance [mm]:	65
8 039 56 016	Radial drilling and milling head ER 32 AX UT	
	Weight [kg]:	6.300
	Notation:	180° reversible
	Employment for:	Main- and sub spindle
	Version:	double spindle
	Tool drive:	Flat (~DIN 1809)
	Shank size [mm]:	55.00
	Shank type:	BMT
	Tool adaption:	ER 32 A - u-tec
	Gear ratio [i]:	1:1
	Torque max [Nm]:	50
	Rotation max [1/min]:	12000
	Rotating direction:	same/opposite
	Coolant:	EXT
	Please note:	stronger bearing
	Center distance [mm]:	65
8 039 56 038	Radial drilling and milling head ER 32 AX UT IC	
	Notation:	offset; 180° reversible
	Version:	± 45° turnable
	Tool drive:	Flat (~DIN 1809)
	Shank size [mm]:	55.00
	Shank type:	BMT
	Tool adaption:	ER 32 A - u-tec
	Gear ratio [i]:	1:1
	Torque max [Nm]:	50
	Rotation max [1/min]:	6000
	Rotating direction:	same
	Coolant:	IC/Ext
	Pressure max [bar]:	140
	Please note:	stronger bearing
	Center distance [mm]:	91
8 039 56 040	Radial drilling and milling head ER 32 AX UT	
	Weight [kg]:	9.360
	Notation:	offset; 180° reversible
	Version:	± 45° turnable
	Tool drive:	Flat (~DIN 1809)
	Shank size [mm]:	55.00
	Shank type:	BMT
	Tool adaption:	ER 32 A - u-tec

Part-#	Name	
	Gear ratio [i]:	1:1
	Torque max [Nm]:	50
	Rotation max [1/min]:	6000
	Rotating direction:	same
	Coolant:	EXT
	Please note:	stronger bearing
	Center distance [mm]:	91
8 039 56 041	Radial drilling and milling head hydro 20	
	Weight [kg]:	9.680
	Notation:	offset; 180° reversible
	Version:	± 45° turnable
	Tool drive:	Flat (~DIN 1809)
	Shank size [mm]:	55.00
	Shank type:	BMT
	Tool adaption:	Hydro clamp Ø 20
	Gear ratio [i]:	1:1
	Torque max [Nm]:	50
	Rotation max [1/min]:	6000
	Rotating direction:	same
	Coolant:	EXT
	Please note:	stronger bearing
	Center distance [mm]:	91
8 040 53 000	Universal head ± 90° adjustable ER 11 AX	
	Weight [kg]:	3.150
	Tool drive:	Flat (~DIN 1809)
	Shank size [mm]:	55.00
	Shank type:	BMT
	Tool adaption:	ER 11 A
	Gear ratio [i]:	1:1
	Torque max [Nm]:	10
	Rotation max [1/min]:	5000
	Rotating direction:	same
	Coolant:	EXT
	Center distance [mm]:	57
8 040 53 002	Universal head ± 90° adjustable ER 11 AX	
	Weight [kg]:	2.880
	Tool drive:	Flat (~DIN 1809)
	Shank size [mm]:	55.00
	Shank type:	BMT
	Tool adaption:	ER 11 A
	Gear ratio [i]:	1:1
	Torque max [Nm]:	10
	Rotation max [1/min]:	6000
	Rotating direction:	same
	Coolant:	EXT
8 040 54 012	Universal head ± 90° adjustable HT 2	
	Version:	75° position can be pinned
	Tool drive:	Flat (~DIN 1809)
	Shank size [mm]:	55.00
	Shank type:	BMT
	Tool adaption:	HT 2
	Gear ratio [i]:	1:1
	Torque max [Nm]:	10
	Rotation max [1/min]:	6000

Part-#	Name
--------	------

Rotating direction: same
Coolant: EXT
Center distance [mm]: 57

8 043 54 000 Universal head +135°/-30° adj. ER16 AX UT



Weight [kg]: 9.850
Notation: offset; 180° reversible
Tool drive: Flat (~DIN 1809)
Shank size [mm]: 55.00
Shank type: BMT
Tool adaption: ER 16 A - u-tec
Gear ratio [i]: 1:1
Torque max [Nm]: 25
Rotation max [1/min]: 6000
Rotating direction: same
Coolant: EXT
Center distance [mm]: 69
Offset [mm]: 60

8 043 54 001 Universal head +135°/-30° adj. ER16AX UTIK

Weight [kg]: 9.920
Notation: offset; 180° reversible
Tool drive: Flat (~DIN 1809)
Shank size [mm]: 55.00
Shank type: BMT
Tool adaption: ER 16 A - u-tec
Gear ratio [i]: 1:1
Torque max [Nm]: 25
Rotation max [1/min]: 6000
Rotating direction: same
Coolant: IC/Ext
Pressure max [bar]: 140
Center distance [mm]: 69
Offset [mm]: 60

8 043 54 002 Universal head +135°/-30° adj. ER16 AX UT

Weight [kg]: 9.930
Notation: offset; 180° reversible
Tool drive: Flat (~DIN 1809)
Shank size [mm]: 55.00
Shank type: BMT
Tool adaption: ER 16 A - u-tec
Gear ratio [i]: 1:2
Torque max [Nm]: 12
Rotation max [1/min]: 12000
Rotating direction: same
Coolant: EXT
Center distance [mm]: 69
Offset [mm]: 60

8 043 54 003 Universal head +135°/-30° adj. ER16AX UTIK

Weight [kg]: 9.900
Notation: offset
Tool drive: Flat (~DIN 1809)
Shank size [mm]: 55.00
Shank type: BMT
Tool adaption: ER 16 A - u-tec

Part-#	Name	
	Gear ratio [i]:	1:2
	Torque max [Nm]:	12
	Rotation max [1/min]:	12000
	Rotating direction:	same
	Coolant:	IC/Ext
	Pressure max [bar]:	140
	Please note:	180° reversible
	Center distance [mm]:	69
	Offset [mm]:	60
8 043 54 019	Universal head +160°/-20° adj. ER16 AX UT	
	Weight [kg]:	6.100
	Notation:	offset; 180° reversible
	Tool drive:	Flat (~DIN 1809)
	Shank size [mm]:	55.00
	Shank type:	BMT
	Tool adaption:	ER 16 A - u-tec
	Gear ratio [i]:	1:1
	Torque max [Nm]:	25
	Rotation max [1/min]:	6000
	Rotating direction:	same
	Coolant:	EXT
	Center distance [mm]:	35
	Offset [mm]:	65
8 043 54 034	Universal head ± 10° adjustable ER 16 AX UT IC	
	Notation:	offset; 180° reversible
	Tool drive:	Flat (~DIN 1809)
	Shank size [mm]:	55.00
	Shank type:	BMT
	Tool adaption:	ER 16 A - u-tec
	Gear ratio [i]:	1:2
	Torque max [Nm]:	25
	Rotation max [1/min]:	12000
	Rotating direction:	same
	Coolant:	IC/Ext
	Pressure max [bar]:	140
	Please note:	Check applicability! note swivel range;
	Center distance [mm]:	62
	Offset [mm]:	48,5
8 050 54 005	Multispindle drilling head ER 16 AX UT	
	Weight [kg]:	6.100
	Notation:	offset
	Version:	2-spindles
	Tool drive:	Flat (~DIN 1809)
	Shank size [mm]:	55.00
	Shank type:	BMT
	Tool adaption:	ER 16 A - u-tec
	Gear ratio [i]:	1:2
	Torque max [Nm]:	16
	Rotation max [1/min]:	12000
	Rotating direction:	same
	Coolant:	EXT
	Offset [mm]:	56

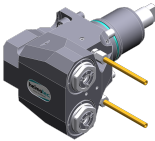

Part-#	Name	
	8 050 54 008	Multispindle drilling head ER 16 AX UT
	Weight [kg]:	5.700
	Notation:	offset
	Version:	2-spindles
	Tool drive:	Flat (~DIN 1809)
	Shank size [mm]:	55.00
	Tool adaption:	ER 16 A - u-tec
	Gear ratio [i]:	1:1
	Torque max [Nm]:	25
	Rotation max [1/min]:	6000
	Rotating direction:	same
Coolant:	EXT	
	8 050 54 014	Multispindle drilling head ER 20 AX UT IC
	Weight [kg]:	5.920
	Notation:	offset
	Version:	2-spindles
	Tool drive:	Flat (~DIN 1809)
	Shank size [mm]:	55.00
	Shank type:	BMT
	Tool adaption:	ER 20 A - u-tec
	Gear ratio [i]:	1:1
	Torque max [Nm]:	25
	Rotation max [1/min]:	6000
Rotating direction:	same	
Coolant:	IC/Ext	
Pressure max [bar]:	140	
Offset [mm]:	58	
	8 050 54 021	Multispindle drilling head ER 16 AX UT IC
	Weight [kg]:	6.110
	Notation:	offset; 180° reversible
	Version:	2-spindles
	Tool drive:	Flat (~DIN 1809)
	Shank size [mm]:	55.00
	Shank type:	BMT
	Tool adaption:	ER 16 A - u-tec
	Gear ratio [i]:	1:2
	Torque max [Nm]:	16
	Rotation max [1/min]:	12000
Rotating direction:	same	
Coolant:	IC/Ext	
Pressure max [bar]:	25	
Offset [mm]:	56	
	8 050 54 036	Multispindle drilling head ER 16 AX UT IC
	Weight [kg]:	6.040
	Notation:	offset; 180° reversible
	Version:	3-spindles
	Tool drive:	Flat (~DIN 1809)
	Shank size [mm]:	55.00
	Shank type:	BMT
	Tool adaption:	ER 16 A - u-tec
	Gear ratio [i]:	1:1
	Torque max [Nm]:	25
	Rotation max [1/min]:	6000
Rotating direction:	same	
Coolant:	IC/Ext	

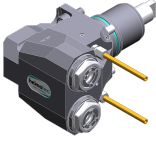
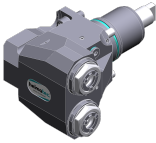

Part-#	Name	
	Pressure max [bar]:	140
	Please note:	2x ER 16 A offset, 1x centered, IC only in 2 x
	Offset [mm]:	56
8 050 54 037	Multispindle drilling head ER 16 AX UT	
	Weight [kg]:	6.900
	Notation:	offset; 180° reversible
	Employment for:	Main- and sub spindle
	Tool drive:	Flat (~DIN 1809)
	Shank size [mm]:	55.00
	Shank type:	BMT
	Tool adaption:	ER 16 A - u-tec
	Gear ratio [i]:	1:1
	Torque max [Nm]:	16/Sp.
	Rotation max [1/min]:	6000
	Rotating direction:	opposite
	Coolant:	no
	Please note:	stronger bearing
	Offset [mm]:	+38,1/-38,1
8 050 54 038	Multispindle drilling head ER 16 AX UT	
	Weight [kg]:	6.870
	Notation:	offset; 180° reversible
	Employment for:	Main- and sub spindle
	Tool drive:	Flat (~DIN 1809)
	Shank size [mm]:	55.00
	Shank type:	BMT
	Tool adaption:	ER 16 A - u-tec
	Gear ratio [i]:	1:1
	Torque max [Nm]:	16/Sp.
	Rotation max [1/min]:	6000
	Rotating direction:	opposite
	Coolant:	EXT
	Please note:	stronger bearing
	Offset [mm]:	+38,1/-38,1
8 053 54 045	Multispindle radial head ER 16 AX UT	
	Weight [kg]:	6.850
	Notation:	180° reversible
	Version:	2-spindles
	Tool drive:	Flat (~DIN 1809)
	Shank size [mm]:	55.00
	Shank type:	BMT
	Tool adaption:	ER 16 A - u-tec
	Gear ratio [i]:	1:1
	Torque max [Nm]:	32/Sp
	Rotation max [1/min]:	12000
	Rotating direction:	same
	Coolant:	EXT
	Center distance [mm]:	75

Part-#	Name	
8 053 54 046	Multispindle radial head ER 16 AX UTIK	
		<p>Notation: 180° reversible Version: 2-spindles Tool drive: Flat (~DIN 1809) Shank size [mm]: 55.00 Shank type: BMT Tool adaption: ER 16 A - u-tec Gear ratio [i]: 1:1 Torque max [Nm]: 32/Sp Rotation max [1/min]: 12000 Rotating direction: same Coolant: IC/Ext Pressure max [bar]: 140 Center distance [mm]: 75</p>
8 053 54 047	Multispindle radial head ER 20 AX UT	
		<p>Notation: 180° reversible Version: 2-spindles Tool drive: Flat (~DIN 1809) Shank size [mm]: 55.00 Shank type: BMT Tool adaption: ER 20 A - u-tec Gear ratio [i]: 1:1 Torque max [Nm]: 32/Sp Rotation max [1/min]: 12000 Rotating direction: same Coolant: EXT Center distance [mm]: 75</p>
8 053 54 048	Multispindle radial head ER 20 AX UTIK	
		<p>Notation: 180° reversible Version: 2-spindles Tool drive: Flat (~DIN 1809) Shank size [mm]: 55.00 Shank type: BMT Tool adaption: ER 20 A - u-tec Gear ratio [i]: 1:1 Torque max [Nm]: 32/Sp Rotation max [1/min]: 12000 Rotating direction: same Coolant: IC/Ext Pressure max [bar]: 140 Center distance [mm]: 75</p>
8 100 15 001	Tool holder radial ø17,1 / minus	
	Employment for:	Angle handpiece or extension CN01
	Tool drive:	Flat (~DIN 1809)
	Shank size [mm]:	55.00
	Shank type:	BMT
	Tool adaption:	Interface ø17,1 / M17x1
	Gear ratio [i]:	1:2
	Rotation max [1/min]:	12000
	Rotating direction:	same
	Coolant:	no
	Center distance [mm]:	77

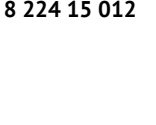
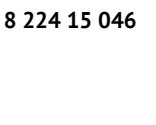

Part-#	Name	
8 102 15 000	Tool holder Ø 17	
	Weight [kg]:	1.930
	Employment for:	Angle handpiece
	Tool drive:	Flat (~DIN 1809)
	Shank size [mm]:	55.00
	Shank type:	BMT
	Tool adaption:	Interface 17
	Gear ratio [i]:	1:1
	Rotation max [1/min]:	6000
	Rotating direction:	same
	Coolant:	no
8 200 10 002	Tool blank	
	Weight [kg]:	4.190
	Notation:	180° reversible
	Shank type:	BMT
	Machine adaption:	Centering key b 20
	Please note:	Housing rigid
8 202 10 006	Basic holder longitudinal seat FN 12	
	Weight [kg]:	0.960
	Notation:	180° reversible
	Shank type:	BMT
	Machine adaption:	Centering key b 20
	Tool adaption:	Interface FN 12
	Coolant:	EXT
8 208 59 003	Test mandrel BMT 55	
	Weight [kg]:	3.080
	Shank size [mm]:	55.00
	Shank type:	BMT
8 209 19 000	Adapter 45 ° for Ecoroll WKT EG5-1-SL00	
	Weight [kg]:	2.590
	Notation:	180° reversible
	Shank type:	BMT
	Machine adaption:	Centering key b 20
	Coolant:	EXT
8 209 58 000	Adapter for sensor m&h RWP 38.41	
	Notation:	180° reversible
	Shank size [mm]:	55.00
	Shank type:	BMT
	Tool adaption:	Ø 32
	Coolant:	no
8 209 58 001	Adapter for sensor m&h IRP 40.01	
	Weight [kg]:	1.340
	Notation:	180° reversible
	Shank size [mm]:	55.00
	Shank type:	BMT
	Tool adaption:	Ø 32
	Coolant:	no

Part-#	Name	
8 209 58 002	Adapter for sensor m&h IRP 40.02	
	Weight [kg]:	1.520
	Notation:	180° reversible
	Shank size [mm]:	55.00
	Shank type:	BMT
	Coolant:	no
8 209 58 003	Adapter for sensor Renishaw RLP	
	Weight [kg]:	1.700
	Notation:	180° reversible
	Shank size [mm]:	55.00
	Shank type:	BMT
	Coolant:	no
8 224 11 003	Cut-off holder sq. 20	
	Weight [kg]:	1.040
	Employment for:	right cutting tools
	Version:	Edge on side of turret
	Shank type:	BMT
	Machine adaption:	Centering key b 20
	Tool adaption:	Sq. 20
	Coolant:	EXT
8 224 11 005	Cut-off holder sq. 20	
	Weight [kg]:	1.100
	Employment for:	left cutting tools
	Version:	Edge on center of turret
	Shank type:	BMT
	Machine adaption:	Centering key b 20
	Tool adaption:	Sq. 20
	Coolant:	EXT
8 224 11 016	Cut-off holder sq. 3/4" R 1441	
	Weight [kg]:	1.110
	Employment for:	right cutting tools
	Version:	Edge on side of turret
	Shank type:	BMT
	Machine adaption:	Centering key b 20
	Tool adaption:	Sq. 3/4" (19,05mm)
	Coolant:	EXT
8 224 11 022	Cut-off holder sq. 20	
	Weight [kg]:	1.350
	Employment for:	right cutting tools
	Version:	Edge on side of turret
	Shank type:	BMT
	Machine adaption:	Centering key b 20
	Tool adaption:	Sq. 20
	Coolant:	EXT
8 224 12 005	Cut-off holder sq. 25	
	Weight [kg]:	1.480
	Shank type:	BMT
	Machine adaption:	Centering key b 20
	Tool adaption:	Sq. 25
	Coolant:	EXT

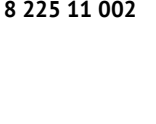
Part-#	Name	
8 224 13 004	Cut-off holder SH 32	
	Weight [kg]:	1.000
	Employment for:	Cut-off tool 32
	Version:	Clampshaft on turret center
	Shank type:	BMT
	Machine adaption:	Centering key b 20
	Tool adaption:	Clampshaft SH 32
	Coolant:	EXT
8 224 13 007	Cut-off holder SH 32	
	Weight [kg]:	1.190
	Employment for:	Cut-off tool 32
	Version:	Clampshaft on turret side
	Shank type:	BMT
	Machine adaption:	Centering key b 20
	Tool adaption:	Clampshaft SH 32
	Coolant:	EXT
8 224 13 013	Cut-off holder SH 32	
	Weight [kg]:	1.480
	Employment for:	Cut-off tool 32
	Version:	Clampshaft on turret side
	Shank type:	BMT
	Machine adaption:	Centering key b 20
	Tool adaption:	Clampshaft SH 32
	Coolant:	EXT
	Please note:	Special
8 224 13 021	Cut-off holder SH 32 IC	
	Weight [kg]:	1.030
	Employment for:	Cut-off tool 32
	Version:	Clampshaft on turret center
	Shank type:	BMT
	Machine adaption:	Centering key b 20
	Tool adaption:	Clampshaft SH 32
	Coolant:	IC/Ext
8 224 14 000	Universal turning holder sq. 20	
	Weight [kg]:	1.730
	Notation:	180° reversible
	Shank type:	BMT
	Machine adaption:	Centering key b 20
	Tool adaption:	Sq. 20
		Sq. 20
	Coolant:	EXT
	Please note:	with spacer strip
8 224 14 016	Universal turning holder sq. 20 IC	
	Weight [kg]:	2.950
	Notation:	180° reversible
	Shank type:	BMT
	Machine adaption:	Centering key b 20
	Tool adaption:	Sq. 20
	Coolant:	IC/Ext
	Pressure max [bar]:	100
	Please note:	Key rail



Part-#	Name	
8 224 15 002	Universal turning holder sq. 25/20	
		
	Weight [kg]:	2.800
	Notation:	180° reversible
	Shank type:	BMT
	Machine adaption:	Centering key b 20
	Tool adaption:	Sq. 25
		Sq. 25
	Coolant:	EXT
	Please note:	With spacer strip for sq. 20
8 224 15 012	Universal turning holder sq. 1"	
		
	Weight [kg]:	2.720
	Shank type:	BMT
	Machine adaption:	Centering key b 20
	Tool adaption:	Sq. 1" (25,4mm)
		Sq. 1" (25,4mm)
	Coolant:	EXT
8 224 15 046	Universal turning holder sq. 25/20	
		
	Weight [kg]:	5.520
	Shank type:	BMT
	Machine adaption:	Centering key b 20
	Tool adaption:	Sq. 25
		Sq. 25
	Coolant:	EXT
	Please note:	Check applicability! with spacer strip for
8 224 15 062	Universal turning holder sq. 25 IC	
		
	Weight [kg]:	3.100
	Shank type:	BMT
	Machine adaption:	Centering key b 20
	Tool adaption:	Sq. 25
		Sq. 25
	Coolant:	IC/Ext
	Pressure max [bar]:	100
	Please note:	Key rail
8 224 15 063	Universal turning holder sq. 1" IC	
		
	Weight [kg]:	3.100
	Shank type:	BMT
	Machine adaption:	Centering key b 20
	Tool adaption:	Sq. 1" (25,4mm)
		Sq. 1" (25,4mm)
	Coolant:	IC/Ext
	Pressure max [bar]:	100
	Please note:	Key rail
8 225 11 002	Cut-off holder sq. 20 R 1432	
		
	Weight [kg]:	1.120
	Employment for:	left cutting tools
	Version:	Edge on side of turret
	Shank type:	BMT
	Machine adaption:	Centering key b 20
	Tool adaption:	Sq. 20
	Coolant:	EXT

Part-#	Name	
8 225 11 005	Cut-off holder sq. 20	
	Weight [kg]:	1.170
	Employment for:	right cutting tools
	Version:	Edge on center of turret
	Shank type:	BMT
	Machine adaption:	Centering key b 20
	Tool adaption:	Sq. 20
	Coolant:	EXT
8 225 11 009	Cut-off holder sq. 3/4" R 1442	
	Weight [kg]:	1.110
	Employment for:	left cutting tools
	Version:	Edge on side of turret
	Shank type:	BMT
	Machine adaption:	Centering key b 20
	Tool adaption:	Sq. 3/4" (19,05mm)
	Coolant:	EXT
8 225 11 012	Cut-off holder sq. 3/4"	
	Weight [kg]:	1.200
	Employment for:	right cutting tools
	Version:	Edge on center of turret
	Shank type:	BMT
	Machine adaption:	Centering key b 20
	Tool adaption:	Sq. 3/4" (19,05mm)
	Coolant:	EXT
8 229 16 001	Tool holder C 4 IC	
	Weight [kg]:	2.400
	Notation:	180° reversible
	Version:	right
	Shank type:	BMT
	Machine adaption:	Centering key b 20
	Tool adaption:	heimatec Capto(TM) C 4
	Coolant:	IC/Ext
	Please note:	Check applicability; note tool length!
	Offset [mm]:	12
8 229 16 003	Tool holder C 4 IC	
	Weight [kg]:	3.330
	Notation:	180° reversible
	Version:	right
	Shank type:	BMT
	Machine adaption:	Centering key b 20
	Tool adaption:	heimatec Capto(TM) C 4
	Coolant:	IC/Ext
	Please note:	Check applicability; note tool length!
	Offset [mm]:	55
8 229 16 008	Tool holder C 4 IC	
	Weight [kg]:	3.430
	Notation:	180° reversible
	Version:	right
	Shank type:	BMT
	Machine adaption:	Centering key b 20
	Tool adaption:	heimatec Capto(TM) C 4
	Coolant:	IC
	Please note:	Check applicability; note tool length!

Part-#	Name	
	Offset [mm]:	55
8 229 16 009	Tool holder C 4 IC	
	Weight [kg]:	2.410
	Notation:	180° reversible
	Version:	right
	Shank type:	BMT
	Machine adaption:	Centering key b 20
	Tool adaption:	heimatec Capto(TM) C 4
	Coolant:	IC
	Please note:	Check applicability; note tool length!
	Offset [mm]:	12
8 229 16 011	Tool holder C 4 IC	
	Weight [kg]:	3.440
	Notation:	180° reversible
	Version:	left
	Shank type:	BMT
	Machine adaption:	Centering key b 20
	Tool adaption:	heimatec Capto(TM) C 4
	Coolant:	IC
	Please note:	Check applicability; note tool length!
	Offset [mm]:	55
8 229 17 003	Tool holder C 5 IC	
	Notation:	180° reversible
	Version:	right
	Shank type:	BMT
	Machine adaption:	Centering key b 20
	Tool adaption:	heimatec Capto(TM) C 5
	Coolant:	IC
	Please note:	Check applicability; note tool length!
	Offset [mm]:	64
8 240 14 017	Boring bar holder Ø 12 - slotted	
	Weight [kg]:	2.900
	Notation:	180° reversible
	Version:	slotted
	Shank type:	BMT
	Machine adaption:	Centering key b 20
	Tool adaption:	Ø 12
	Coolant:	EXT
	Pressure max [bar]:	100
	Center distance [mm]:	75
8 240 14 022	Boring bar holder Ø 10 - slotted	
	Weight [kg]:	2.900
	Notation:	180° reversible
	Version:	slotted
	Shank type:	BMT
	Machine adaption:	Centering key b 20
	Tool adaption:	Ø 10
	Coolant:	EXT
	Pressure max [bar]:	100
	Center distance [mm]:	75

Part-#	Name	
	8 240 15 003 Boring bar holder Ø 16 DIN 1835 E	3.020
	Weight [kg]:	BMT
	Shank type:	Centering key b 20
	Machine adaption:	Whistle-Notch (DIN 1835 E) 16
	Tool adaption:	IC/Ext
	Coolant:	75
	Center distance [mm]:	
	8 240 15 004 Tool holder C 3 IC	3.580
	Weight [kg]:	180° reversible; offset
	Notation:	BMT
	Shank type:	Centering key b 20
	Machine adaption:	heimatec Capto(TM) C 3
	Tool adaption:	IC
	Coolant:	75
Center distance [mm]:		
	8 240 15 006 Collet chuck holder ER 25	3.520
	Weight [kg]:	180° reversible
	Notation:	BMT
	Shank type:	Centering key b 20
	Machine adaption:	ER 25
	Tool adaption:	IC/Ext
	Coolant:	Insert reversible
Please note:	75	
Center distance [mm]:		
	8 240 15 007 Insert drill holder 16 IC	4.540
	Weight [kg]:	180° reversible
	Notation:	BMT
	Shank type:	Whistle-Notch (DIN 1835 E) 16
	Machine adaption:	IC
	Tool adaption:	75
	Coolant:	
Center distance [mm]:		
	8 240 15 019 Collet chuck holder ER 25 AX UT IC	3.380
	Weight [kg]:	180° reversible; offset
	Notation:	BMT
	Shank type:	Centering key b 20
	Machine adaption:	ER 25 A - u-tec
	Tool adaption:	IC/Ext
	Coolant:	75
Center distance [mm]:		
	8 240 15 039 Boring bar holder Ø 16 - slotted	3.000
	Weight [kg]:	180° reversible
	Notation:	BMT
	Shank type:	Centering key b 20
	Machine adaption:	Ø 16
	Tool adaption:	EXT
	Coolant:	75
Center distance [mm]:		

Part-#	Name	
8 240 16 004	Tool holder HT 4 IC	
	Weight [kg]:	2.890
	Notation:	180° reversible; offset
	Shank type:	BMT
	Machine adaption:	Centering key b 20
	Tool adaption:	HT 4
	Coolant:	IC/Ext
	Center distance [mm]:	75
8 240 16 009	Insert drill holder 20 IC	
	Weight [kg]:	4.480
	Notation:	180° reversible
	Shank type:	BMT
	Tool adaption:	Whistle-Notch (DIN 1835 E) 20
	Coolant:	IC
	Center distance [mm]:	75
8 240 16 030	Boring bar holder Ø 20	
	Weight [kg]:	3.940
	Notation:	180° reversible
	Shank type:	BMT
	Machine adaption:	Centering key b 20
	Tool adaption:	Ø 20
	Coolant:	IC/Ext
	Please note:	Housing rigid
	Center distance [mm]:	75
8 240 16 040	Tool holder C 4 IC	
	Weight [kg]:	3.130
	Notation:	180° reversible
	Version:	offset; right
	Shank type:	BMT
	Machine adaption:	Centering key b 20
	Tool adaption:	heimatec Capto(TM) C 4
	Coolant:	IC/Ext
	Please note:	Check applicability; note tool length!
	Center distance [mm]:	75
8 240 16 045	Tool holder C 4 IC	
	Weight [kg]:	2.960
	Notation:	180° reversible
	Version:	offset; right
	Shank type:	BMT
	Machine adaption:	Centering key b 20
	Tool adaption:	heimatec Capto(TM) C 4
	Coolant:	IC
	Please note:	Check applicability; note tool length!
	Center distance [mm]:	75
8 240 16 046	Tool holder C 4 IC	
	Weight [kg]:	3.480
	Notation:	180° reversible
	Version:	right
	Shank type:	BMT
	Machine adaption:	Centering key b 20
	Tool adaption:	heimatec Capto(TM) C 4
	Coolant:	IC

Part-#	Name	
	Please note:	Check applicability; note tool length!
	Center distance [mm]:	75
8 240 16 051	Tool holder C 4 IC	
	Weight [kg]:	3.430
	Notation:	180° reversible
	Version:	left
	Shank type:	BMT
	Machine adaption:	Centering key b 20
	Tool adaption:	heimatec Capto(TM) C 4
	Coolant:	IC
	Please note:	Check applicability; note tool length!
	Center distance [mm]:	75
8 240 16 054	Tool holder C 4 IC	
	Weight [kg]:	2.840
	Notation:	180° reversible
	Version:	left; special
	Shank type:	BMT
	Machine adaption:	Centering key b 20
	Tool adaption:	heimatec Capto(TM) C 4
	Coolant:	IC/Ext
	Please note:	Check applicability; note tool length!
	Center distance [mm]:	40
8 240 16 072	Tool holder C 4 IC	
	Weight [kg]:	4.000
	Notation:	180° reversible
	Version:	right
	Shank type:	BMT
	Machine adaption:	Centering key b 20
	Tool adaption:	heimatec Capto(TM) C 4
	Coolant:	IC
	Please note:	Check applicability; note tool length!
	Center distance [mm]:	95
8 240 16 077	Boring bar holder Ø 20 - slotted	
	Weight [kg]:	3.120
	Notation:	180° reversible
	Version:	slotted
	Shank type:	BMT
	Machine adaption:	Centering key b 20
	Tool adaption:	Ø 20
	Coolant:	EXT
	Pressure max [bar]:	100
	Center distance [mm]:	75
8 240 17 005	Boring bar holder Ø 25	
	Weight [kg]:	3.820
	Notation:	180° reversible
	Shank type:	BMT
	Machine adaption:	Centering key b 20
	Tool adaption:	Ø 25
	Coolant:	IC/Ext
	Please note:	Housing rigid
	Center distance [mm]:	75

Part-#	Name	
8 240 17 008	Boring bar holder Ø 25 DIN 1835 E	
	Weight [kg]:	3.210
	Notation:	offset; 180° reversible
	Version:	Special
	Shank type:	BMT
	Machine adaption:	Centering key b 20
	Tool adaption:	Whistle-Notch (DIN 1835 E) 25
	Coolant:	IC/Ext
	Center distance [mm]:	75
8 240 17 011	Boring bar holder Ø 25,4 (1")	
	Weight [kg]:	3.800
	Notation:	180° reversible
	Shank type:	BMT
	Machine adaption:	Centering key b 20
	Tool adaption:	Ø 1" (25,4mm)
	Coolant:	IC/Ext
	Pressure max [bar]:	140
	Please note:	Housing rigid
	Center distance [mm]:	75
8 240 17 023	Insert drill holder 25 IC	
	Weight [kg]:	4.380
	Notation:	180° reversible
	Shank type:	BMT
	Tool adaption:	Whistle-Notch (DIN 1835 E) 25
	Coolant:	IC
	Center distance [mm]:	75
8 240 17 031	Boring bar holder Ø 30	
	Notation:	180° reversible
	Version:	Special
	Shank type:	BMT
	Machine adaption:	Centering key b 20
	Tool adaption:	Ø 30
	Coolant:	EXT
	Center distance [mm]:	112
8 240 17 032	Boring bar holder Ø 30	
	Notation:	180° reversible
	Version:	Special
	Shank type:	BMT
	Machine adaption:	Centering key b 20
	Tool adaption:	Ø 30
	Coolant:	EXT
	Center distance [mm]:	105
8 240 17 049	Boring bar holder Ø 1" offset	
	Weight [kg]:	2.450
	Notation:	180° reversible
	Version:	offset
	Shank type:	BMT
	Machine adaption:	Centering key b 20
	Tool adaption:	Ø 1" (25,4mm)
	Coolant:	IC/Ext
	Please note:	Housing rigid
	Center distance [mm]:	75

Part-#	Name	
8 240 17 052	Boring bar holder Ø 25	
	Weight [kg]:	4.430
	Employment for:	Main spindle
	Version:	long; special
	Shank type:	BMT
	Machine adaption:	Centering key b 20
	Tool adaption:	Ø 25
	Coolant:	IC/Ext
	Center distance [mm]:	75
8 240 17 065	Boring bar holder Ø 25 - slotted	
	Weight [kg]:	3.670
	Notation:	180° reversible
	Shank type:	BMT
	Machine adaption:	Centering key b 20
	Tool adaption:	Ø 25
	Coolant:	EXT
	Please note:	Housing rigid
	Center distance [mm]:	75
8 240 17 078	Boring bar holder Ø 1 1/4" - slotted	
	Weight [kg]:	3.440
	Notation:	180° reversible
	Shank type:	BMT
	Machine adaption:	Centering key b 20
	Tool adaption:	Ø 1 1/4" (31,75mm)
	Coolant:	EXT
	Please note:	Housing rigid
	Center distance [mm]:	75
8 240 17 096	Tool holder C 5 IC	
	Weight [kg]:	5.030
	Notation:	180° reversible
	Version:	right
	Shank type:	BMT
	Machine adaption:	Centering key b 20
	Tool adaption:	heimatec Capto(TM) C 5
	Coolant:	IC
	Please note:	Check applicability; note tool length!
	Center distance [mm]:	75
8 240 17 106	Boring bar holder Ø 25	
	Weight [kg]:	4.800
	Notation:	180° reversible
	Shank type:	BMT
	Machine adaption:	Centering key b 20
	Tool adaption:	Ø 25
	Coolant:	IC/Ext
	Please note:	Check applicability! housing rigid
	Center distance [mm]:	95

Part-#	Name	
8 240 17 114	Boring bar holder Ø 1"	
	Weight [kg]:	4.760
	Notation:	180° reversible
	Shank type:	BMT
	Machine adaption:	Centering key b 20
	Tool adaption:	Ø 1" (25,4mm)
	Coolant:	IC/Ext
	Please note:	Check applicability! housing rigid
	Center distance [mm]:	95
8 240 17 115	Boring bar holder Ø 1 1/4"	
	Weight [kg]:	4.620
	Notation:	180° reversible
	Shank type:	BMT
	Machine adaption:	Centering key b 20
	Tool adaption:	Ø 1 1/4" (31,75mm)
	Coolant:	IC/Ext
	Please note:	Check applicability! housing rigid
	Center distance [mm]:	95
8 240 17 116	Boring bar holder Ø 1 1/4"	
	Weight [kg]:	2.440
	Notation:	180° reversible
	Shank type:	BMT
	Machine adaption:	Centering key b 20
	Tool adaption:	Ø 1 1/4" (31,75mm)
	Coolant:	IC/Ext
	Please note:	Housing rigid
	Center distance [mm]:	75
8 240 18 010	Boring bar holder Ø 32	
	Weight [kg]:	3.640
	Notation:	180° reversible
	Shank type:	BMT
	Machine adaption:	Centering key b 20
	Tool adaption:	Ø 32
	Coolant:	IC/Ext
	Pressure max [bar]:	140
	Please note:	Housing rigid
	Center distance [mm]:	75
8 240 18 012	Boring bar holder Ø 32 offset	
	Weight [kg]:	2.420
	Notation:	180° reversible
	Version:	offset
	Shank type:	BMT
	Machine adaption:	Centering key b 20
	Tool adaption:	Ø 32
	Coolant:	IC/Ext
	Please note:	Housing rigid
	Center distance [mm]:	75

Part-#	Name	
8 240 18 021	Insert drill holder 32 IC	
	Weight [kg]:	4.200
	Notation:	180° reversible
	Shank type:	BMT
	Tool adaption:	Whistle-Notch (DIN 1835 E) 32
	Coolant:	IC
	Center distance [mm]:	75
8 240 18 033	Boring bar holder Ø 1 1/4"	
	Weight [kg]:	3.630
	Notation:	180° reversible
	Shank type:	BMT
	Machine adaption:	Centering key b 20
	Tool adaption:	Ø 1 1/4" (31,75mm)
	Coolant:	IC/Ext
	Please note:	Housing rigid
	Center distance [mm]:	75
8 240 18 037	Boring bar holder Ø 1 1/2"	
	Weight [kg]:	4.540
	Notation:	180° reversible
	Shank type:	BMT
	Machine adaption:	Centering key b 20
	Tool adaption:	Ø 1 1/2" (38,1mm)
	Coolant:	IC/Ext
	Center distance [mm]:	75
8 240 18 085	Boring bar holder Ø 32	
	Weight [kg]:	4.605
	Notation:	180° reversible
	Shank type:	BMT
	Machine adaption:	Centering key b 20
	Tool adaption:	Ø 32
	Coolant:	IC/Ext
	Please note:	Check applicability! housing rigid
	Center distance [mm]:	95
8 240 18 088	Boring bar holder Ø 32 offset	
	Weight [kg]:	4.200
	Notation:	offset
	Shank type:	BMT
	Machine adaption:	Centering key b 20
	Tool adaption:	Ø 32
	Coolant:	IC/Ext
	Please note:	Front edge ø32- adapter 20mm from turret center offset
	Center distance [mm]:	75
8 240 18 098	Boring bar holder Ø 1 1/4"	
	Notation:	180° reversible
	Shank type:	BMT
	Machine adaption:	Centering key b 20
	Tool adaption:	Ø 1 1/4" (31,75mm)
	Coolant:	IC/Ext
	Please note:	Check applicability!
	Center distance [mm]:	100



Part-#	Name	
8 240 18 102	Boring bar holder Ø 32 offset	
	Weight [kg]:	6.780
	Notation:	180° reversible
	Version:	offset
	Shank type:	BMT
	Machine adaption:	Centering key b 20
	Tool adaption:	Ø 32
	Coolant:	IC
	Pressure max [bar]:	100
	Please note:	Check applicability! length
	Center distance [mm]:	80
8 240 19 009	Boring bar holder Ø 40	
	Weight [kg]:	4.480
	Notation:	180° reversible
	Shank type:	BMT
	Machine adaption:	Centering key b 20
	Tool adaption:	Ø 40
	Coolant:	IC/Ext
	Center distance [mm]:	75
8 240 19 025	Insert drill holder 40 IC	
	Weight [kg]:	4.740
	Notation:	180° reversible
	Shank type:	BMT
	Tool adaption:	Whistle-Notch (DIN 1835 E) 40
	Coolant:	IC
	Center distance [mm]:	75
8 240 19 105	Boring bar holder Ø 40	
	Weight [kg]:	2.400
	Notation:	180° reversible
	Shank type:	BMT
	Machine adaption:	Centering key b 20
	Tool adaption:	Ø 40
	Coolant:	IC/Ext
	Center distance [mm]:	35
8 240 19 139	Boring bar holder Ø 40	
	Weight [kg]:	4.760
	Notation:	180° reversible
	Shank type:	BMT
	Machine adaption:	Centering key b 20
	Tool adaption:	Ø 40
	Coolant:	IC
	Please note:	Check applicability!
	Center distance [mm]:	100
8 240 19 142	Boring bar holder Ø 40 offset	
	Weight [kg]:	5.000
	Notation:	offset
	Shank type:	BMT
	Machine adaption:	Centering key b 20
	Tool adaption:	Ø 40
	Coolant:	IC/Ext
	Please note:	Front edge Ø40- adapter 60mm from turret center offset

Part-#	Name	
	Center distance [mm]:	75
8 240 19 143	Boring bar holder Ø 40 offset	
	Weight [kg]:	4.000
	Notation:	offset
	Shank type:	BMT
	Machine adaption:	Centering key b 20
	Tool adaption:	Ø 40
	Coolant:	IC/Ext
	Please note:	Front edge Ø40- adapter 20mm from turret center offset
	Center distance [mm]:	75
8 244 11 002	Facing holder sq. 20	
	Weight [kg]:	2.340
	Notation:	180° reversible
	Shank type:	BMT
	Machine adaption:	Centering key b 20
	Tool adaption:	Sq. 20
	Coolant:	EXT
8 244 11 009	Facing holder sq. 20	
	Weight [kg]:	4.090
	Notation:	180° reversible
	Version:	Special; extended version
	Shank type:	BMT
	Machine adaption:	Centering key b 20
	Tool adaption:	Sq. 20
	Coolant:	EXT
8 244 12 005	Facing holder sq. 1"	
	Weight [kg]:	3.570
	Shank type:	BMT
	Machine adaption:	Centering key b 20
	Tool adaption:	Sq. 1" (25,4mm)
	Coolant:	EXT
8 244 12 027	Facing holder sq. 25 IC	
	Weight [kg]:	3.640
	Shank type:	BMT
	Machine adaption:	Centering key b 20
	Tool adaption:	Sq. 25
	Coolant:	IC/Ext
	Pressure max [bar]:	100
8 249 15 013	Double tool holder C 3 IC	
	Weight [kg]:	4.210
	Notation:	180° reversible
	Employment for:	Main- and sub spindle
	Version:	offset; right
	Shank type:	BMT
	Machine adaption:	Centering key b 20
	Tool adaption:	heimatec Capto(TM) C 3
		heimatec Capto(TM) C 3
	Coolant:	IC
	Please note:	Check applicability; note tool length!
	Center distance [mm]:	82,5

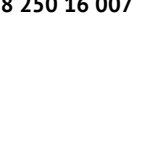

Part-#	Name	
8 249 16 013	Double tool holder C 4 IC	
	Weight [kg]:	5.290
	Notation:	180° reversible
	Employment for:	Main- and sub spindle
	Version:	right
	Shank type:	BMT
	Machine adaption:	Centering key b 20
	Tool adaption:	heimatec Capto(TM) C 4 heimatec Capto(TM) C 4
	Coolant:	IC/Ext
	Please note:	Check applicability; note tool length!
	Center distance [mm]:	75
8 249 16 015	Double tool holder C 4 IC	
	Weight [kg]:	5.370
	Notation:	180° reversible
	Employment for:	Main- and sub spindle
	Version:	right
	Shank type:	BMT
	Machine adaption:	Centering key b 20
	Tool adaption:	heimatec Capto(TM) C 4 heimatec Capto(TM) C 4
	Coolant:	IC
	Please note:	Check applicability; note tool length!
	Center distance [mm]:	75
8 249 16 027	Double tool holder C 4 IC	
	Weight [kg]:	6.280
	Notation:	180° reversible
	Employment for:	Main- and sub spindle
	Version:	right
	Shank type:	BMT
	Machine adaption:	Centering key b 20
	Tool adaption:	heimatec Capto(TM) C 4 heimatec Capto(TM) C 4
	Coolant:	IC
	Please note:	Check applicability; note tool length!
	Center distance [mm]:	95
8 249 17 003	Double boring bar holder Ø 25	
	Weight [kg]:	3.770
	Notation:	180° reversible
	Shank type:	BMT
	Machine adaption:	Centering key b 20
	Tool adaption:	Ø 25
	Coolant:	IC/Ext
	Please note:	Housing rigid
	Center distance [mm]:	75
8 249 18 003	Adapter for sensor m&h IRP 40.01	
	Weight [kg]:	5.230
	Notation:	180° reversible
	Shank type:	BMT
	Machine adaption:	Centering key b 20
	Tool adaption:	Ø 32
	Coolant:	no
	Center distance [mm]:	112

Part-#	Name	
8 249 18 008	Double boring bar holder Ø 32	
		<p>Weight [kg]: 3.800 Notation: 180° reversible Shank type: BMT Machine adaption: Centering key b 20 Tool adaption: Ø 32 Coolant: IC/Ext Please note: Housing rigid Center distance [mm]: 75</p>
8 250 15 004	Multiple tool holder C 3 IC	
		<p>Weight [kg]: 4.110 Notation: 180° reversible Employment for: Main- and sub spindle Version: right Shank type: BMT Machine adaption: Centering key b 20 Tool adaption: heimatec Capto(TM) C 3 heimatec Capto(TM) C 3 Coolant: IC Please note: Check applicability; note tool length! Offset [mm]: ±55</p>
8 250 16 003	Multiple tool holder C 4 IC	
		<p>Weight [kg]: 4.490 Employment for: Main- and sub spindle Version: right Shank type: BMT Machine adaption: Centering key b 20 Tool adaption: heimatec Capto(TM) C 4 heimatec Capto(TM) C 4 Coolant: IC/Ext Please note: Check applicability; note tool length! Offset [mm]: ±55</p>
8 250 16 005	Multiple tool holder C 4 IC	
		<p>Weight [kg]: 4.620 Employment for: Main- and sub spindle Version: right Shank type: BMT Machine adaption: Centering key b 20 Tool adaption: heimatec Capto(TM) C 4 Coolant: IC Please note: Check applicability; note tool length! Offset [mm]: ±55</p>
8 250 16 007	Double tool holder C 4 IC	
		<p>Weight [kg]: 4.630 Notation: 180° reversible Employment for: Main- and sub spindle Version: left Shank type: BMT Machine adaption: Centering key b 20 Tool adaption: heimatec Capto(TM) C 4 Coolant: IC Please note: Check applicability; note tool length! Offset [mm]: ±55</p>

Part-#	Name	
8 251 11 000	Double turning holder sq. 20	
	Weight [kg]:	2.250
	Shank type:	BMT
	Machine adaption:	Centering key b 20
	Tool adaption:	Sq. 20
	Coolant:	EXT
8 251 11 003	Double turning holder sq. 20	
	Weight [kg]:	2.420
	Notation:	180° reversible
	Employment for:	right cutting tools
	Shank type:	BMT
	Machine adaption:	Centering key b 20
	Tool adaption:	Sq. 20
		Sq. 20
	Coolant:	EXT
8 251 11 007	Double turning holder sq. 3/4"	
	Weight [kg]:	2.390
	Notation:	180° reversible
	Employment for:	right cutting tools
	Shank type:	BMT
	Machine adaption:	Centering key b 20
	Tool adaption:	Sq. 3/4" (19,05mm)
		Sq. 3/4" (19,05mm)
	Coolant:	EXT
8 251 12 006	Double turning holder sq. 25	
	Weight [kg]:	4.910
	Notation:	180° reversible
	Employment for:	right cutting tools
	Shank type:	BMT
	Machine adaption:	Centering key b 20
	Tool adaption:	Sq. 25
	Coolant:	EXT
8 251 13 005	Combi multiple holder 6x sq. 3/4" IC	
	Weight [kg]:	6.300
	Employment for:	Main- and sub spindle
	Shank type:	BMT
	Machine adaption:	Centering key b 20
	Tool adaption:	Sq. 3/4" (19,05mm)
		Sq. 3/4" (19,05mm)
		Sq. 3/4" (19,05mm)
		Sq. 3/4" (19,05mm)
	Coolant:	IC/Ext
	Pressure max [bar]:	100
	Please note:	Key rail
8 251 14 006	Combi multiple holder 6x sq. 20	
	Weight [kg]:	6.160
	Notation:	180° reversible
	Shank type:	BMT
	Machine adaption:	Centering key b 20
	Tool adaption:	Sq. 20
		Sq. 20
		Sq. 20

Part-#	Name	
	Coolant:	Sq. 20 EXT
8 251 14 012	Combi multiple holder 3x sq. 20	
	Weight [kg]:	3.800
	Shank type:	BMT
	Machine adaption:	Centering key b 20
	Tool adaption:	Sq. 20 Sq. 20
	Coolant:	EXT
8 251 14 018	Combi multiple holder 6x sq. 3/4"	
	Weight [kg]:	6.220
	Notation:	180° reversible
	Shank type:	BMT
	Machine adaption:	Centering key b 20
	Tool adaption:	Sq. 3/4" (19,05mm) Sq. 3/4" (19,05mm) Sq. 3/4" (19,05mm) Sq. 3/4" (19,05mm)
	Coolant:	EXT
8 251 14 028	Combi multiple holder 3x sq. 3/4"	
	Weight [kg]:	3.760
	Shank type:	BMT
	Machine adaption:	Centering key b 20
	Tool adaption:	Sq. 3/4" (19,05mm) Sq. 3/4" (19,05mm)
	Coolant:	EXT
8 251 14 033	Combi multiple holder 3x sq. 20	
	Weight [kg]:	3.740
	Shank type:	BMT
	Machine adaption:	Centering key b 20
	Tool adaption:	Sq. 20 Sq. 20
	Coolant:	EXT
8 251 14 074	Combi multiple holder 6x sq. 20 IC	
	Weight [kg]:	6.160
	Notation:	180° reversible
	Employment for:	Main- and sub spindle
	Shank type:	BMT
	Machine adaption:	Centering key b 20
	Tool adaption:	Sq. 20 Sq. 20 Sq. 20 Sq. 20
	Coolant:	IC/Ext
	Pressure max [bar]:	100
	Please note:	Key rail

Part-#	Name	
8 251 14 075	Combi multiple holder 3x sq. 20 IC	
	Shank type:	BMT
	Machine adaption:	Centering key b 20
	Tool adaption:	Sq. 20
		Sq. 20
	Coolant:	IC/Ext
	Pressure max [bar]:	100
	Please note:	Key rail
8 251 14 098	Combi multiple holder 3x sq. 20 IC	
	Weight [kg]:	3.480
	Shank type:	BMT
	Machine adaption:	Centering key b 20
	Tool adaption:	Sq. 20
		Sq. 20
	Coolant:	IC/Ext
	Pressure max [bar]:	100
	Please note:	Key rail
8 251 14 100	Combi double turning holder sq. 20 IC	
	Weight [kg]:	5.300
	Notation:	180° reversible
	Employment for:	Main- and sub spindle
	Shank type:	BMT
	Machine adaption:	Centering key b 20
	Tool adaption:	Sq. 20
		Sq. 20
		Sq. 20
		Sq. 20
	Coolant:	IC/Ext
	Pressure max [bar]:	100
	Please note:	Key rail
8 251 15 031	Multiple tool holder C 3 IC	
	Weight [kg]:	5.930
	Employment for:	Main- and sub spindle
	Version:	right
	Shank type:	BMT
	Machine adaption:	Centering key b 20
	Tool adaption:	heimatec Capto(TM) C 3
		heimatec Capto(TM) C 3
	Coolant:	IC
	Please note:	Check applicability; note tool length!
	Offset [mm]:	±60
8 251 15 034	Multiple tool holder C 3 IC	
	Weight [kg]:	4.290
	Version:	right
	Shank type:	BMT
	Machine adaption:	Centering key b 20
	Tool adaption:	heimatec Capto(TM) C 3
		heimatec Capto(TM) C 3 - 15°
	Coolant:	IC
	Please note:	Check applicability; note tool length!
	Offset [mm]:	60

Part-#	Name	
8 251 15 048	Combi double turning holder sq. 25 IC	
	Notation: Employment for: Shank type: Machine adaption: Tool adaption: Coolant: Pressure max [bar]: Please note:	180° reversible Main- and sub spindle BMT Centering key b 20 Sq. 25 Sq. 25 Sq. 25 Sq. 25 IC/Ext 100 Key rail
8 251 16 007	Multiple tool holder C 4 IC	
	Weight [kg]: Version: Shank type: Machine adaption: Tool adaption: Coolant: Please note: Offset [mm]:	4.490 right BMT Centering key b 20 heimatec Capto(TM) C 4 heimatec Capto(TM) C 4 - 15° IC Check applicability; note tool length! 64
8 251 16 008	Multiple tool holder C 4 IC	
	Weight [kg]: Employment for: Version: Shank type: Machine adaption: Tool adaption: Coolant: Please note: Offset [mm]:	6.420 Main- and sub spindle right BMT Centering key b 20 heimatec Capto(TM) C 4 heimatec Capto(TM) C 4 IC Check applicability; note tool length! ±64
8 253 15 003	Multiple tool holder C 3 IC	
	Version: Shank type: Machine adaption: Tool adaption: Coolant: Please note: Center distance [mm]:	offset; right BMT Centering key b 20 heimatec Capto(TM) C 3 heimatec Capto(TM) C 3 - 15° IC Check applicability; note tool length! 82,5
8 253 16 038	Multiple tool holder C 4 IC	
	Weight [kg]: Version: Shank type: Machine adaption: Tool adaption: Coolant: Please note: Center distance [mm]:	6.060 right BMT Centering key b 20 heimatec Capto(TM) C 4 heimatec Capto(TM) C 4 - 15° IC Use necessarily check; note tool length 75

Part-#	Name	
8 253 16 039	Multiple tool holder C 4 IC	
	Weight [kg]:	4.910
	Version:	offset; right
	Shank type:	BMT
	Machine adaption:	Centering key b 20
	Tool adaption:	heimatec Capto(TM) C 4 heimatec Capto(TM) C 4 - 15°
	Coolant:	IC
	Please note:	Check applicability; note tool length!
	Center distance [mm]:	75
8 253 16 040	Multiple tool holder C 4 IC	
	Weight [kg]:	6.070
	Version:	right
	Shank type:	BMT
	Machine adaption:	Centering key b 20
	Tool adaption:	heimatec Capto(TM) C 4 heimatec Capto(TM) C 4 - 15°
	Coolant:	IC
	Please note:	Check applicability; note tool length!
	Center distance [mm]:	75
8 253 16 041	Multiple tool holder C 4 IC	
	Weight [kg]:	4.900
	Version:	offset; right
	Shank type:	BMT
	Machine adaption:	Centering key b 20
	Tool adaption:	heimatec Capto(TM) C 4 heimatec Capto(TM) C 4 - 15°
	Coolant:	IC
	Please note:	Check applicability; note tool length!
	Center distance [mm]:	75
8 253 17 016	Double boring bar holder Ø 25	
	Weight [kg]:	2.660
	Notation:	180° reversible
	Shank type:	BMT
	Machine adaption:	Centering key b 20
	Tool adaption:	Ø 25 Ø 25
	Coolant:	IC/Ext
	Center distance [mm]:	47,5/82,5
8 253 17 017	Multiple boring bar holder 3x Ø 25	
	Weight [kg]:	4.900
	Notation:	180° reversible
	Employment for:	Main- and sub spindle
	Shank type:	BMT
	Machine adaption:	Centering key b 20
	Tool adaption:	Ø 25 Ø 25
	Coolant:	IC/Ext
	Center distance [mm]:	47,5/82,5

Part-#	Name	
8 253 17 034	Double boring bar holder Ø 1"	
	Weight [kg]:	2.480
	Shank type:	BMT
	Machine adaption:	Centering key b 20
	Tool adaption:	Ø 1" (25,4mm)
	Coolant:	IC/Ext
	Center distance [mm]:	47,5/82,5
8 253 17 047	Multiple boring bar holder 3x Ø 1"	
	Weight [kg]:	4.890
	Notation:	180° reversible
	Employment for:	Main- and sub spindle
	Shank type:	BMT
	Machine adaption:	Centering key b 20
	Tool adaption:	Ø 1" (25,4mm) Ø 1" (25,4mm)
	Coolant:	IC/Ext
	Center distance [mm]:	47,5/82,5
8 253 17 048	Multiple boring bar holder 2x Ø 25	
	Weight [kg]:	5.930
	Employment for:	Main spindle
	Version:	long; special
	Shank type:	BMT
	Machine adaption:	Centering key b 20
	Tool adaption:	Ø 25 Ø 25 - 15°
	Coolant:	IC/Ext
	Center distance [mm]:	75
8 254 14 002	Multiple facing holder 3x sq. 20	
	Weight [kg]:	5.860
	Employment for:	Main spindle
	Version:	long; special
	Shank type:	BMT
	Machine adaption:	Centering key b 20
	Tool adaption:	Sq. 20 Sq. 20
	Coolant:	EXT
	Center distance [mm]:	70
8 259 12 010	Multiple turning holder 2x sq. 20	
	Weight [kg]:	2.890
	Notation:	180° reversible
	Version:	Y-axes offset
	Shank type:	BMT
	Machine adaption:	Centering key b 20
	Tool adaption:	Sq. 20 Sq. 20
	Coolant:	EXT
8 259 15 001	Multiple holder C 3 and sq. 20	
	Weight [kg]:	3.960
	Notation:	180° reversible
	Shank type:	BMT
	Machine adaption:	Centering key b 20
	Tool adaption:	Sq. 20 heimatec Capto(TM) C 3

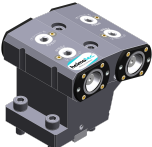
Part-#	Name	
	Coolant:	IC/Ext
	Center distance [mm]:	55
8 259 15 002	Multiple holder C 3 and sq. 20	
	Employment for:	Main- and sub spindle
	Shank type:	BMT
	Machine adaption:	Centering key b 20
	Tool adaption:	Sq. 20
		Sq. 20
		Sq. 20
		Sq. 20
	Coolant:	IC/Ext
	Please note:	note machining direction for C 3!
	Center distance [mm]:	82,5
8 259 15 003	Multiple holder C 3 and sq. 20	
	Weight [kg]:	7.040
	Employment for:	Main- and sub spindle
	Shank type:	BMT
	Machine adaption:	Centering key b 20
	Tool adaption:	Sq. 20
		Sq. 20
		Sq. 20
		Sq. 20
	Coolant:	IC/Ext
	Please note:	note machining direction for C 3!
	Center distance [mm]:	82,5
8 259 15 013	Multiple tool holder C 3 IC	
	Weight [kg]:	6.420
	Employment for:	Main- and sub spindle
	Version:	right
	Shank type:	BMT
	Machine adaption:	Centering key b 20
	Tool adaption:	heimatec Capto(TM) C 3
		heimatec Capto(TM) C 3
	Coolant:	IC
	Please note:	Check applicability; note tool length!
	Center distance [mm]:	82,5
8 259 15 014	Multiple tool holder C 3 IC	
	Weight [kg]:	6.470
	Employment for:	Main- and sub spindle
	Version:	offset; right
	Shank type:	BMT
	Machine adaption:	Centering key b 20
	Tool adaption:	heimatec Capto(TM) C 3
		heimatec Capto(TM) C 3
	Coolant:	IC
	Please note:	Check applicability; note tool length!
	Center distance [mm]:	82,5

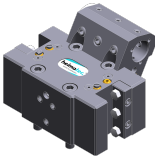
Part-#	Name	
8 259 16 007	Multiple tool holder C 4 IC	
	Weight [kg]:	9.320
	Employment for:	Main- and sub spindle
	Version:	right
	Shank type:	BMT
	Machine adaption:	Centering key b 20
	Tool adaption:	heimatec Capto(TM) C 4 heimatec Capto(TM) C 4
	Coolant:	IC
	Please note:	Check applicability; note tool length!
	Center distance [mm]:	75
8 259 17 001	Multiple holder 2x C 3 and Ø 25	
	Weight [kg]:	5.340
	Employment for:	Main- and sub spindle
	Shank type:	BMT
	Machine adaption:	Centering key b 20
	Tool adaption:	heimatec Capto(TM) C 3 heimatec Capto(TM) C 3 - 15° Ø 25
	Coolant:	IC/Ext
	Please note:	note machining direction for C 3!
	Center distance [mm]:	47,5/82,5
8 259 19 004	Multiple holder Ø 25 and sq. 20	
	Weight [kg]:	6.500
	Employment for:	Main- and sub spindle
	Shank type:	BMT
	Machine adaption:	Centering key b 20
	Tool adaption:	Sq. 20 Sq. 20 Sq. 20 Sq. 20
	Coolant:	IC/Ext
	Center distance [mm]:	82,5
8 259 19 012	Multiple holder Ø 1" and sq. 3/4"	
	Weight [kg]:	6.610
	Employment for:	Main- and sub spindle
	Shank type:	BMT
	Machine adaption:	Centering key b 20
	Tool adaption:	Sq. 3/4" (19,05mm) Sq. 3/4" (19,05mm) Sq. 3/4" (19,05mm) Sq. 3/4" (19,05mm)
	Coolant:	IC/Ext
	Pressure max [bar]:	140
	Center distance [mm]:	82,5
8 263 19 012	Tool holder with rotating centering point	
	Weight [kg]:	4.340
	Notation:	180° reversible
	Version:	Special
	Shank type:	BMT
	Machine adaption:	Centering key b 20
	Rotation max [1/min]:	6000
	Coolant:	EXT

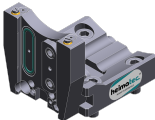
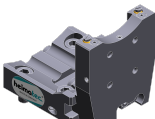
Part-#	Name	
	Please note:	Taper roller bearings
	Center distance [mm]:	75
8 263 19 013	Tool holder with rotating centering point	
	Weight [kg]:	4.290
	Notation:	180° reversible
	Version:	Special
	Shank type:	BMT
	Machine adaption:	Centering key b 20
	Rotation max [1/min]:	6000
	Coolant:	EXT
	Please note:	Taper roller bearings
	Center distance [mm]:	75
8 320 12 010	Cut-off holder, height adjustable SH 26 IC	
	Weight [kg]:	1.680
	Notation:	180° reversible
	Shank type:	BMT
	Machine adaption:	Centering key b 20
	Tool adaption:	Clampshaft SH 26
	Coolant:	IC/Ext
	Pressure max [bar]:	70
8 320 12 020	Cut-off holder, height adjustable SH 26 IC	
	Notation:	180° reversible
	Shank type:	BMT
	Machine adaption:	Centering key b 20
	Tool adaption:	Clampshaft SH 26
	Coolant:	IC/Ext
	Pressure max [bar]:	70
	Please note:	with offset cut-off tool holder
8 320 13 002	Cut-off holder, height adjustable SH 32 IC	
	Weight [kg]:	1.570
	Notation:	180° reversible
	Shank type:	BMT
	Machine adaption:	Centering key b 20
	Tool adaption:	Clampshaft SH 32
	Coolant:	IC/Ext
	Pressure max [bar]:	70
8 320 13 010	Cut-off holder, height adjustable SH 32 IC	
	Weight [kg]:	1.730
	Notation:	180° reversible
	Shank type:	BMT
	Machine adaption:	Centering key b 20
	Tool adaption:	Clampshaft SH 32
	Coolant:	IC/Ext
	Pressure max [bar]:	70
	Please note:	Clampshaft internal

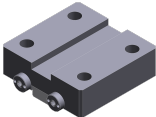
Part-#	Name	
8 320 13 015	Cut-off holder, height adjustable SH 32 IC	
	Weight [kg]:	1.830
	Notation:	180° reversible
	Shank type:	BMT
	Machine adaption:	Centering key b 20
	Tool adaption:	Clampshaft SH 32
	Coolant:	IC/Ext
	Pressure max [bar]:	70
	Please note:	with offset cut-off tool holder
8 782 16 001	Spacer plate 20mm	
	Shank type:	BMT
	Machine adaption:	Centering key b 20
	Tool adaption:	Centering key slot b 20
	Coolant:	EXT
	Please note:	Plate without fastening screws !
8 782 16 003	Spacer plate 25mm	
	Shank type:	BMT
	Machine adaption:	Centering key b 20
	Tool adaption:	Centering key slot b 20
	Coolant:	EXT
	Please note:	Plate without fastening screws !

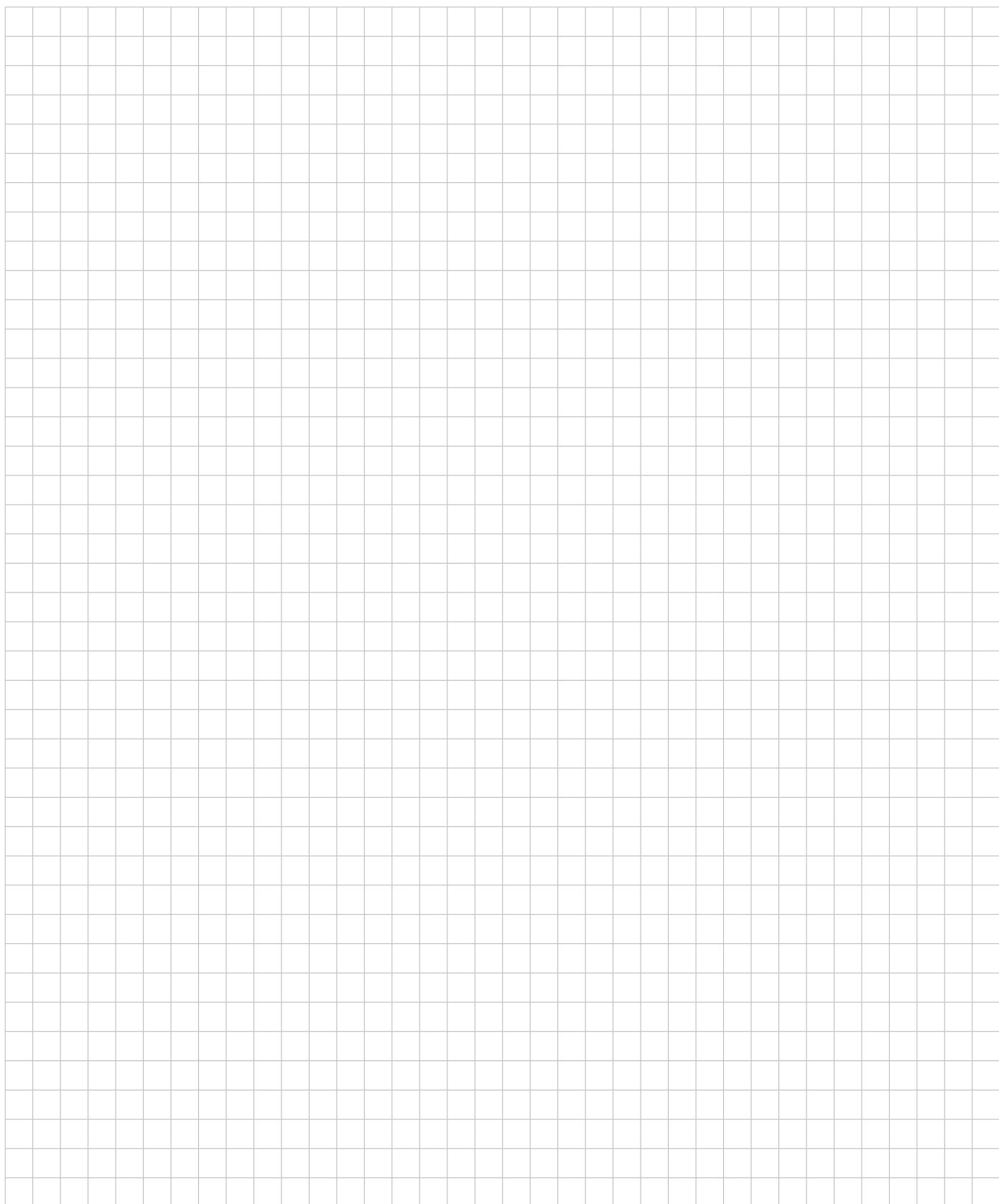

heimatec.u-tec®

heimatec.com

Products / Tool change systems /
u-tec® Tool-changing system



versions see catalog

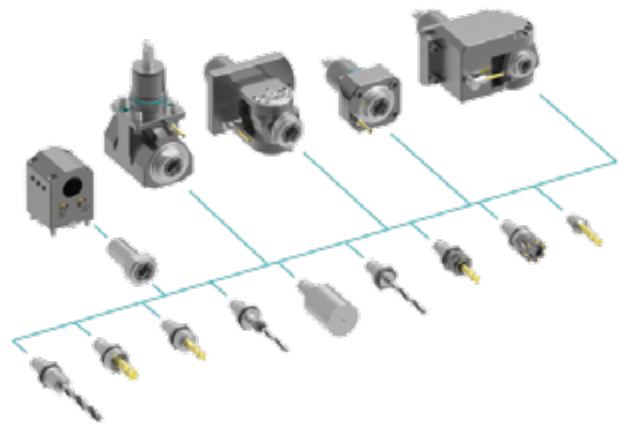

heimatec.easy-quick

heimatec.com

Products / Tool change systems /
easy-quick HT quick-changing system



versions see catalog

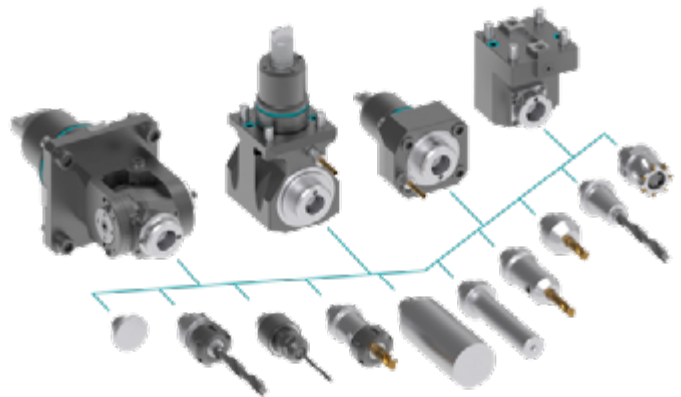

heimatec.Capto™

heimatec.com

Products / Tool change systems /
heimatec.Capto™ quick-changing system



versions see catalog

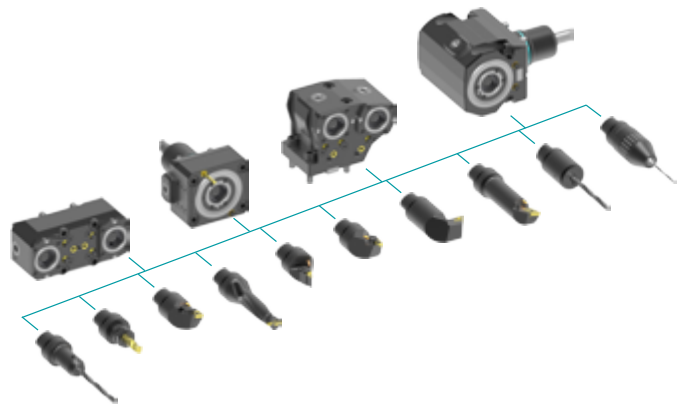

heimatec.accessories

heimatec.com

Products / Accessories



versions see catalog





● heimatec overseas branches

○ global representations of heimatec

heimatec[®]

heimatec GmbH
Präzisionswerkzeuge
Carl-Benz-Str. 4
77871 Renchen
Germany

T +49 7843 9466 0
www.heimatec.com
info@heimatec.com

Please find the contact details of our worldwide trading partners on our website:
<https://heimatec.com/business-partners>