

Nakamura
NTY 3 - 100



High-tech from heimatec - heimatec - Tools and systems for productive turning and milling

heimatec belongs to the international technology and quality leaders for precision tools and specializes in the development and production of high-precision static and live tools for all CNC lathes, CNC turn-/mill machines and CNC machining centers.

The range of products* spans from static BMT and VDI tool holders, live tools up to highly complex customer-specific individual solutions. heimatec, headquartered in Renchen, has a own subsidiary in Asia and India and numerous representatives as well as trading partners all over the world.

*OUR PRODCUTS

Static tool holders

Live tool units

Precision tools

Tools for turning and machining centres

Tools for swiss type lathes

Tool changing and uick-change systems

Tool systems for gear production

Digital tool management

This catalogue, including all its parts, is protected by copyright. Any use outside the restricted limitations of the Copyright Act without the consent of heimatec is inadmissible and liable to prosecution. This applies in particular to duplication, translation, microfilming and storage and processing in electronic systems.





heimatec GmbH reserves the right to make technical changes at any time without giving prior notice. This applies in particular to adjustments at any time to meet new or changed international standards, or in case of further developments of our products or manufacturing processes.



The current version of our General Terms and Conditions can be found on our website.

Part-#	Name	
8 010 44 055	Axial milling and drill holder ER 20 AX UT	
	Weight [kg]:	1.450
	Tool drive:	Flat (~DIN 1809)
	Shank size [mm]:	44.00
	Shank type:	BMT
	Tool adaption:	ER 20 A - u-tec
	Gear ratio [i]:	1:1
	Torque max [Nm]:	16
	Rotation max [1/min]:	6000
	Rotating direction:	same
	Coolant:	EXT
	Please note:	Combi bearing
8 010 44 056	Axial milling and drill holder ER 20 AX UT IC	
	Weight [kg]:	1.440
	Tool drive:	Flat (~DIN 1809)
	Shank size [mm]:	44.00
	Shank type:	BMT
	Tool adaption:	ER 20 A - u-tec
	Gear ratio [i]:	1:1
	Torque max [Nm]:	16
	Rotation max [1/min]:	6000
	Rotating direction:	same
	Coolant:	IC/Ext
	Pressure max [bar]:	25
	Please note:	Combi bearing
8 010 44 071	Axial drilling and milling head Weldon 14	
	Weight [kg]:	1.640
	Tool drive:	Flat (~DIN 1809)
	Shank size [mm]:	44.00
	Shank type:	BMT
	Tool adaption:	Weldon (DIN 1835 b) 14
	Gear ratio [i]:	1:1
	Torque max [Nm]:	16
	Rotation max [1/min]:	6000
	Rotating direction:	same
	Coolant:	EXT
	Please note:	Combi bearing
8 010 44 085	Axial drilling and milling head ER 20 AX UT IC	
	Weight [kg]:	1.970
	Tool drive:	Flat (~DIN 1809)
	Shank size [mm]:	44.00
	Shank type:	BMT
	Tool adaption:	ER 20 A - u-tec
	Gear ratio [i]:	1:1
	Torque max [Nm]:	16
	Rotation max [1/min]:	10000
	Rotating direction:	same
	Coolant:	IC/Ext
	Pressure max [bar]:	70
	Please note:	High pressure version

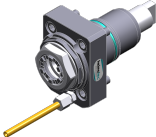
Part-#	Name	
8 010 44 091	Axial drilling and milling head ER 20 AX UT	
	Weight [kg]:	1.530
	Tool drive:	Flat (~DIN 1809)
	Shank size [mm]:	44.00
	Shank type:	BMT
	Tool adaption:	ER 20 A - u-tec
	Gear ratio [i]:	1:1
	Torque max [Nm]:	32
	Rotation max [1/min]:	12000
	Rotating direction:	same
	Coolant:	EXT
8 010 44 092	Axial drilling and milling head ER 20 AX UT IC	
	Weight [kg]:	1.560
	Tool drive:	Flat (~DIN 1809)
	Shank size [mm]:	44.00
	Shank type:	BMT
	Tool adaption:	ER 20 A - u-tec
	Gear ratio [i]:	1:1
	Torque max [Nm]:	32
	Rotation max [1/min]:	12000
	Rotating direction:	same
	Coolant:	IC/Ext
	Pressure max [bar]:	25
8 010 44 093	Axial drilling and milling head ER 20 AX UT IC	
	Weight [kg]:	2.020
	Tool drive:	Flat (~DIN 1809)
	Shank size [mm]:	44.00
	Shank type:	BMT
	Tool adaption:	ER 20 A - u-tec
	Gear ratio [i]:	1:1
	Torque max [Nm]:	32
	Rotation max [1/min]:	12000
	Rotating direction:	same
	Coolant:	IC/Ext
	Pressure max [bar]:	100
	Please note:	Dryrun possible
8 010 45 081	Axial drilling and milling head Weldon 16	
	Tool drive:	Flat (~DIN 1809)
	Shank size [mm]:	44.00
	Shank type:	BMT
	Tool adaption:	Weldon (DIN 1835 b) 16
	Gear ratio [i]:	1:1
	Torque max [Nm]:	16
	Rotation max [1/min]:	6000
	Rotating direction:	same
	Coolant:	EXT
	Please note:	Combi bearing

Part-#	Name	
8 010 45 082	Axial drilling and milling head Weldon 16 IC	
	Tool drive:	Flat (~DIN 1809)
	Shank size [mm]:	44.00
	Shank type:	BMT
	Tool adaption:	Weldon (DIN 1835 b) 16
	Gear ratio [i]:	1:1
	Torque max [Nm]:	16
	Rotation max [1/min]:	6000
	Rotating direction:	same
	Coolant:	IC/Ext
	Pressure max [bar]:	25
	Please note:	Combi bearing
8 010 45 160	Axial drilling and milling head ER 25 AX UT	
	Weight [kg]:	1.530
	Tool drive:	Flat (~DIN 1809)
	Shank size [mm]:	44.00
	Shank type:	BMT
	Tool adaption:	ER 25 A - u-tec
	Gear ratio [i]:	1:1
	Torque max [Nm]:	16
	Rotation max [1/min]:	8000
	Rotating direction:	same
	Coolant:	EXT
	Please note:	stronger bearing
8 010 45 170	Axial drilling and milling head ER 25 IC	
	Weight [kg]:	1.550
	Tool drive:	Flat (~DIN 1809)
	Shank size [mm]:	44.00
	Shank type:	BMT
	Tool adaption:	ER 25
	Gear ratio [i]:	1:1
	Torque max [Nm]:	32
	Rotation max [1/min]:	6000
	Rotating direction:	same
	Coolant:	IC/Ext
	Pressure max [bar]:	25
	Please note:	Combi bearing
8 010 45 191	Axial milling and drill holder ER 25 AX UT	
	Tool drive:	Flat (~DIN 1809)
	Shank size [mm]:	44.00
	Shank type:	BMT
	Tool adaption:	ER 25 A - u-tec
	Gear ratio [i]:	1:1
	Torque max [Nm]:	32
	Rotation max [1/min]:	8000
	Rotating direction:	same
	Coolant:	EXT
	Please note:	Combi bearing

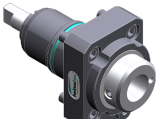
Part-#	Name	
	8 010 45 192	Axial milling and drill holder ER 25 AX UT IC
		Weight [kg]: 1.800 Tool drive: Flat (~DIN 1809) Shank size [mm]: 44.00 Shank type: BMT Tool adaption: ER 25 A - u-tec Gear ratio [i]: 1:1 Torque max [Nm]: 32 Rotation max [1/min]: 8000 Rotating direction: same Coolant: IC/Ext Pressure max [bar]: 25 Please note: Combi bearing
	8 010 45 193	Axial milling and drill holder ER 25 AX UT IC
		Weight [kg]: 2.340 Tool drive: Flat (~DIN 1809) Shank size [mm]: 44.00 Shank type: BMT Tool adaption: ER 25 A - u-tec Gear ratio [i]: 1:1 Torque max [Nm]: 32 Rotation max [1/min]: 8000 Rotating direction: same Coolant: IC/Ext Pressure max [bar]: 100 Please note: Combi bearing; dryrun possible
	8 010 45 208	Axial drilling and milling head ER 25 AX UT
		Weight [kg]: 1.500 Tool drive: Flat (~DIN 1809) Shank size [mm]: 44.00 Shank type: BMT Tool adaption: ER 25 A - u-tec Gear ratio [i]: 1:1 Torque max [Nm]: 32 Rotation max [1/min]: 12000 Rotating direction: same Coolant: EXT
	8 010 45 209	Axial drilling and milling head ER 25 AX UT IC
		Weight [kg]: 1.750 Tool drive: Flat (~DIN 1809) Shank size [mm]: 44.00 Shank type: BMT Tool adaption: ER 25 A - u-tec Gear ratio [i]: 1:1 Torque max [Nm]: 32 Rotation max [1/min]: 12000 Rotating direction: same Coolant: IC/Ext Pressure max [bar]: 25

Part-#	Name	
8 010 45 210	Axial drilling and milling head ER 25 AX UT IC	
	Weight [kg]:	1.980
	Tool drive:	Flat (~DIN 1809)
	Shank size [mm]:	44.00
	Shank type:	BMT
	Tool adaption:	ER 25 A - u-tec
	Gear ratio [i]:	1:1
	Torque max [Nm]:	32
	Rotation max [1/min]:	15000
	Rotating direction:	same
	Coolant:	IC/Ext
	Pressure max [bar]:	100
	Please note:	Dryrun possible
8 010 46 149	Axial drilling and milling head HT 4 IC	
	Tool drive:	Flat (~DIN 1809)
	Shank size [mm]:	44.00
	Shank type:	BMT
	Tool adaption:	HT 4
	Gear ratio [i]:	1:1
	Torque max [Nm]:	16
	Rotation max [1/min]:	6000
	Rotating direction:	same
	Coolant:	IC/Ext
	Pressure max [bar]:	25
	Please note:	Combi bearing
8 010 46 277	Axial drilling and milling head HT 4 IC	
	Weight [kg]:	1.400
	Tool drive:	Flat (~DIN 1809)
	Shank size [mm]:	44.00
	Shank type:	BMT
	Tool adaption:	HT 4
	Gear ratio [i]:	1:1
	Torque max [Nm]:	16
	Rotation max [1/min]:	8000
	Rotating direction:	same
	Coolant:	IC/Ext
	Pressure max [bar]:	25
	Please note:	stronger bearing
8 010 46 323	Axial drilling and milling head Weldon 20	
	Weight [kg]:	1.940
	Tool drive:	Flat (~DIN 1809)
	Shank size [mm]:	44.00
	Shank type:	BMT
	Tool adaption:	Weldon (DIN 1835 b) 20
	Gear ratio [i]:	1:1
	Torque max [Nm]:	32
	Rotation max [1/min]:	12000
	Rotating direction:	same
	Coolant:	EXT

Part-#	Name	
8 011 44 017	Axial milling head universal arbor 16	
	Weight [kg]:	1.560
	Tool drive:	Flat (~DIN 1809)
	Shank size [mm]:	44.00
	Shank type:	BMT
	Tool adaption:	Universal arbor 16
	Gear ratio [i]:	1:1
	Torque max [Nm]:	32
	Rotation max [1/min]:	6000
	Rotating direction:	same
	Coolant:	EXT
	Please note:	Combi bearing
8 011 44 018	Axial milling head universal arbor 3/4"	
	Weight [kg]:	1.480
	Tool drive:	Flat (~DIN 1809)
	Shank size [mm]:	44.00
	Shank type:	BMT
	Tool adaption:	Universal arbor 3/4" (19,05mm)
	Gear ratio [i]:	1:1
	Torque max [Nm]:	25
	Rotation max [1/min]:	8000
	Rotating direction:	same
	Coolant:	EXT
	Please note:	Combi bearing
8 011 45 024	Axial milling head universal arbor 22	
	Weight [kg]:	1.620
	Tool drive:	Flat (~DIN 1809)
	Shank size [mm]:	44.00
	Shank type:	BMT
	Tool adaption:	Universal arbor 22
	Gear ratio [i]:	1:1
	Torque max [Nm]:	32
	Rotation max [1/min]:	6000
	Rotating direction:	same
	Coolant:	EXT
	Please note:	Combi bearing
8 011 45 033	Axial milling head universal arbor 1"	
	Tool drive:	Flat (~DIN 1809)
	Shank size [mm]:	44.00
	Shank type:	BMT
	Tool adaption:	Universal arbor 1" (25,4mm)
	Gear ratio [i]:	1:1
	Torque max [Nm]:	16
	Rotation max [1/min]:	6000
	Rotating direction:	same
	Coolant:	EXT
	Please note:	Combi bearing

Part-#	Name	
8 013 43 001 	Axial drilling and milling head ER 11	
	Weight [kg]:	1.850
	Tool drive:	Flat (~DIN 1809)
	Shank size [mm]:	44.00
	Shank type:	BMT
	Tool adaption:	ER 11
	Gear ratio [i]:	1:4
	Torque max [Nm]:	2,5
	Rotation max [1/min]:	48000
	Rotating direction:	same
Coolant:	EXT	
8 013 44 002 	Axial drilling and milling head ER 16 AX UT	
	Weight [kg]:	1.850
	Tool drive:	Flat (~DIN 1809)
	Shank size [mm]:	44.00
	Shank type:	BMT
	Tool adaption:	ER 16 A - u-tec
	Gear ratio [i]:	1:4
	Torque max [Nm]:	5
	Rotation max [1/min]:	24000
	Rotating direction:	same
Coolant:	EXT	
8 013 44 003	Axial drilling and milling head ER 16 AX UT IC	
	Tool drive:	Flat (~DIN 1809)
	Shank size [mm]:	44.00
	Shank type:	BMT
	Tool adaption:	ER 16 A - u-tec
	Gear ratio [i]:	1:4
	Torque max [Nm]:	5
	Rotation max [1/min]:	24000
	Rotating direction:	same
	Coolant:	IC/Ext
Pressure max [bar]:	80	
8 019 44 014	Axial drilling and milling head ER 16	
	Weight [kg]:	3.860
	Notation:	offset; 180° reversible
	Tool drive:	Flat (~DIN 1809)
	Shank size [mm]:	44.00
	Shank type:	BMT
	Tool adaption:	ER 16
	Gear ratio [i]:	1:2
	Torque max [Nm]:	16
	Rotation max [1/min]:	12000
Rotating direction:	opposite	
Coolant:	EXT	
Please note:	Umsetzbarkeit check !	
Offset [mm]:	34,5	

Part-#	Name	
8 019 44 017	Axial drilling and milling head HT 2	
	Weight [kg]:	3.780
	Notation:	offset; 180° reversible
	Tool drive:	Flat (~DIN 1809)
	Shank size [mm]:	44.00
	Shank type:	BMT
	Tool adaption:	HT 2
	Gear ratio [i]:	1:2
	Torque max [Nm]:	16
	Rotation max [1/min]:	12000
	Rotating direction:	opposite
	Coolant:	EXT
	Please note:	Umsetzbarkeit check !
	Offset [mm]:	34,5
8 019 44 040	Axial drilling and milling head ER 16 AX UT	
	Weight [kg]:	3.780
	Notation:	offset; 180° reversible
	Tool drive:	Flat (~DIN 1809)
	Shank size [mm]:	44.00
	Shank type:	BMT
	Tool adaption:	ER 16 A - u-tec
	Gear ratio [i]:	2:1
	Torque max [Nm]:	40
	Rotation max [1/min]:	3000
	Rotating direction:	opposite
	Coolant:	EXT
	Please note:	Umsetzbarkeit check !
	Offset [mm]:	34,5
8 019 44 050	Axial drilling and milling head ER 16 AX UT	
	Weight [kg]:	3.830
	Notation:	offset; 180° reversible
	Tool drive:	Flat (~DIN 1809)
	Shank size [mm]:	44.00
	Shank type:	BMT
	Tool adaption:	ER 16 A - u-tec
	Gear ratio [i]:	1:3
	Torque max [Nm]:	8
	Rotation max [1/min]:	18000
	Rotating direction:	opposite
	Coolant:	EXT
	Please note:	Umsetzbarkeit check !
	Offset [mm]:	34,5
8 019 44 052	Axial drilling and milling head ER 16 AX UT IC	
	Weight [kg]:	4.530
	Notation:	offset
	Tool drive:	Flat (~DIN 1809)
	Shank size [mm]:	44.00
	Shank type:	BMT
	Tool adaption:	ER 16 A - u-tec
	Gear ratio [i]:	1:3
	Torque max [Nm]:	8
	Rotation max [1/min]:	18000
	Rotating direction:	opposite
	Coolant:	IC/Ext
	Pressure max [bar]:	140



Part-#	Name	
	Please note:	180° reversible
	Offset [mm]:	34,5
8 019 44 108	Axial drilling and milling head ER 16 AX UT	
	Notation:	offset; 180° reversible
	Tool drive:	Flat (~DIN 1809)
	Shank size [mm]:	44.00
	Shank type:	BMT
	Tool adaption:	ER 16 A - u-tec
	Gear ratio [i]:	1:1
	Torque max [Nm]:	16
	Rotation max [1/min]:	8000
	Rotating direction:	opposite
	Coolant:	EXT
	Please note:	Umsetzbarkeit check !
	Offset [mm]:	34,5
8 019 44 109	Axial drilling and milling head ER 16 AX UT IC	
	Weight [kg]:	4.450
	Notation:	offset
	Tool drive:	Flat (~DIN 1809)
	Shank size [mm]:	44.00
	Shank type:	BMT
	Tool adaption:	ER 16 A - u-tec
	Gear ratio [i]:	1:1
	Torque max [Nm]:	16
	Rotation max [1/min]:	8000
	Rotating direction:	opposite
	Coolant:	IC/Ext
	Pressure max [bar]:	140
	Please note:	180° reversible
	Offset [mm]:	34,5
8 019 44 124	Axial drilling and milling head ER 16 AX UT IC	
	Weight [kg]:	4.470
	Notation:	offset
	Tool drive:	Flat (~DIN 1809)
	Shank size [mm]:	44.00
	Shank type:	BMT
	Tool adaption:	ER 16 A - u-tec
	Gear ratio [i]:	2:1
	Torque max [Nm]:	40
	Rotation max [1/min]:	3000
	Rotating direction:	opposite
	Coolant:	IC/Ext
	Pressure max [bar]:	140
	Please note:	180° reversible
	Offset [mm]:	34,5
8 019 44 138	Axial drilling and milling head ER 16 AX UT	
	Weight [kg]:	3.120
	Notation:	offset; 180° reversible
	Tool drive:	Flat (~DIN 1809)
	Shank size [mm]:	44.00
	Shank type:	BMT
	Tool adaption:	ER 16 A - u-tec
	Gear ratio [i]:	1:2

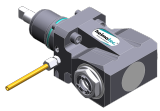

Part-#	Name	
	Torque max [Nm]:	16
	Rotation max [1/min]:	20000
	Rotating direction:	opposite
	Coolant:	EXT
	Please note:	Umsetzbarkeit check !
	Offset [mm]:	34,5
8 030 44 060	Radial drilling and milling head ER 16 AX UT IC	
	Notation:	180° reversible
	Tool drive:	Flat (~DIN 1809)
	Shank size [mm]:	44.00
	Shank type:	BMT
	Tool adaption:	ER 16 A - u-tec
	Gear ratio [i]:	1:1
	Torque max [Nm]:	16
	Rotation max [1/min]:	6000
	Rotating direction:	opposite
	Coolant:	IC/Ext
	Pressure max [bar]:	140
	Please note:	Combi bearing
	Center distance [mm]:	60
8 030 44 065	Radial drilling and milling head ER 16 AX UT	
	Weight [kg]:	4.360
	Notation:	180° reversible
	Tool drive:	Flat (~DIN 1809)
	Shank size [mm]:	44.00
	Shank type:	BMT
	Tool adaption:	ER 16 A - u-tec
	Gear ratio [i]:	1:2
	Torque max [Nm]:	8
	Rotation max [1/min]:	12000
	Rotating direction:	same
	Coolant:	EXT
	Please note:	stronger bearing
	Center distance [mm]:	68,5
8 030 44 067	Angle-mill- and drill holder ER 20 AX UT	
	Weight [kg]:	4.000
	Notation:	180° reversible
	Tool drive:	Flat (~DIN 1809)
	Shank size [mm]:	44.00
	Shank type:	BMT
	Tool adaption:	ER 20 A - u-tec
	Gear ratio [i]:	1:1
	Torque max [Nm]:	16
	Rotation max [1/min]:	8000
	Rotating direction:	opposite
	Coolant:	EXT
	Please note:	Combi bearing
	Center distance [mm]:	75

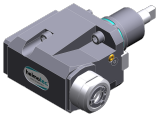

Part-#	Name	
8 030 44 068	Angle-mill- and drill holder ER 20 AX UT IC	
	Weight [kg]:	4.300
	Notation:	180° reversible
	Tool drive:	Flat (~DIN 1809)
	Shank size [mm]:	44.00
	Shank type:	BMT
	Tool adaption:	ER 20 A - u-tec
	Gear ratio [i]:	1:1
	Torque max [Nm]:	16
	Rotation max [1/min]:	6000
	Rotating direction:	opposite
	Coolant:	IC/Ext
	Pressure max [bar]:	140
	Please note:	Combi bearing
	Center distance [mm]:	75
8 030 44 069	Radial drilling and milling head ER 20 AX UT	
	Weight [kg]:	4.520
	Notation:	180° reversible
	Tool drive:	Flat (~DIN 1809)
	Shank size [mm]:	44.00
	Shank type:	BMT
	Tool adaption:	ER 20 A - u-tec
	Gear ratio [i]:	1:2
	Torque max [Nm]:	8
	Rotation max [1/min]:	12000
	Rotating direction:	same
	Coolant:	EXT
	Please note:	stronger bearing
	Center distance [mm]:	68,5
8 030 44 070	Radial drilling and milling head ER 20 AX UT IC	
	Weight [kg]:	4.570
	Notation:	180° reversible
	Tool drive:	Flat (~DIN 1809)
	Shank size [mm]:	44.00
	Shank type:	BMT
	Tool adaption:	ER 20 A - u-tec
	Gear ratio [i]:	1:2
	Torque max [Nm]:	8
	Rotation max [1/min]:	12000
	Rotating direction:	same
	Coolant:	IC/Ext
	Pressure max [bar]:	140
	Please note:	stronger bearing
	Center distance [mm]:	68,5
8 030 44 083	Radial drilling and milling head ER 16 AX UT	
	Weight [kg]:	4.580
	Notation:	180° reversible
	Tool drive:	Flat (~DIN 1809)
	Shank size [mm]:	44.00
	Shank type:	BMT
	Tool adaption:	ER 16 A - u-tec
	Gear ratio [i]:	1:2
	Torque max [Nm]:	8
	Rotation max [1/min]:	12000
	Rotating direction:	same

Part-#	Name	
	Coolant:	EXT
	Please note:	stronger bearing; Umsetzbarkeit check !
	Center distance [mm]:	75
8 030 44 172	Radial drilling and milling head ER 16 AX UT	
	Weight [kg]:	4.360
	Notation:	180° reversible
	Tool drive:	Flat (~DIN 1809)
	Shank size [mm]:	44.00
	Shank type:	BMT
	Tool adaption:	ER 16 A - u-tec
	Gear ratio [i]:	1:3
	Torque max [Nm]:	8
	Rotation max [1/min]:	18000
	Rotating direction:	same
	Coolant:	EXT
	Center distance [mm]:	68,5
8 030 44 173	Radial drilling and milling head ER 16 AX UT IC	
	Weight [kg]:	4.380
	Notation:	180° reversible
	Tool drive:	Flat (~DIN 1809)
	Shank size [mm]:	44.00
	Shank type:	BMT
	Tool adaption:	ER 16 A - u-tec
	Gear ratio [i]:	1:3
	Torque max [Nm]:	8
	Rotation max [1/min]:	18000
	Rotating direction:	same
	Coolant:	IC/Ext
	Pressure max [bar]:	140
	Center distance [mm]:	68,5
8 030 44 179	Radial drilling and milling head ER 16 AX UT	
	Weight [kg]:	4.040
	Notation:	180° reversible
	Tool drive:	Flat (~DIN 1809)
	Shank size [mm]:	44.00
	Shank type:	BMT
	Tool adaption:	ER 16 A - u-tec
	Gear ratio [i]:	1:4
	Torque max [Nm]:	5
	Rotation max [1/min]:	24000
	Rotating direction:	opposite
	Coolant:	EXT
	Center distance [mm]:	60
8 030 44 180	Radial drilling and milling head ER 16 AX UT IC	
	Weight [kg]:	4.300
	Notation:	180° reversible
	Tool drive:	Flat (~DIN 1809)
	Shank size [mm]:	44.00
	Shank type:	BMT
	Tool adaption:	ER 16 A - u-tec
	Gear ratio [i]:	1:4
	Torque max [Nm]:	5
	Rotation max [1/min]:	24000

Part-#	Name
--------	------

Rotating direction: opposite
Coolant: IC/Ext
Pressure max [bar]: 140
Center distance [mm]: 60

8 030 44 214 Radial drilling and milling head ER 20 AX UT

Weight [kg]: 4.750
Notation: 180° reversible
Tool drive: Flat (~DIN 1809)
Shank size [mm]: 44.00
Shank type: BMT
Tool adaption: ER 20 A - u-tec
Gear ratio [i]: 1:2
Torque max [Nm]: 8
Rotation max [1/min]: 12000
Rotating direction: same
Coolant: EXT
Please note: stronger bearing; check applicability !
Center distance [mm]: 75

8 030 44 225 Radial drilling and milling head ER 20 AX UT



Weight [kg]: 3.830
Notation: 180° reversible
Tool drive: Flat (~DIN 1809)
Shank size [mm]: 44.00
Shank type: BMT
Tool adaption: ER 20 A - u-tec
Gear ratio [i]: 1:1
Torque max [Nm]: 32
Rotation max [1/min]: 12000
Rotating direction: opposite
Coolant: EXT
Center distance [mm]: 60

8 030 44 226 Radial drilling and milling head ER 20 AX UT IC

Weight [kg]: 4.250
Notation: 180° reversible
Tool drive: Flat (~DIN 1809)
Shank size [mm]: 44.00
Shank type: BMT
Tool adaption: ER 20 A - u-tec
Gear ratio [i]: 1:1
Torque max [Nm]: 32
Rotation max [1/min]: 12000
Rotating direction: opposite
Coolant: IC/Ext
Pressure max [bar]: 140
Center distance [mm]: 60

8 030 44 237 Angle-mill- and drill holder ER 20 AX UT

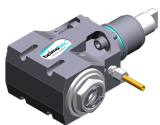

Weight [kg]: 3.880
Notation: 180° reversible
Tool drive: Flat (~DIN 1809)
Shank size [mm]: 44.00
Shank type: BMT
Tool adaption: ER 20 A - u-tec
Gear ratio [i]: 1:1

Part-#	Name	
		Torque max [Nm]: 32
		Rotation max [1/min]: 8000
		Rotating direction: opposite
		Coolant: EXT
		Please note: Combi bearing
		Center distance [mm]: 60
8 030 44 238	Angle-mill- and drill holder ER 20 AX UT IC	
	Notation:	180° reversible
	Tool drive:	Flat (~DIN 1809)
	Shank size [mm]:	44.00
	Shank type:	BMT
	Tool adaption:	ER 20 A - u-tec
	Gear ratio [i]:	1:1
	Torque max [Nm]:	32
	Rotation max [1/min]:	8000
	Rotating direction:	opposite
	Coolant:	IC/Ext
	Pressure max [bar]:	140
	Please note:	Combi bearing
	Center distance [mm]:	60
8 030 45 158	Radial drilling and milling head ER 25 AX UT	
	Weight [kg]:	4.520
	Notation:	180° reversible
	Tool drive:	Flat (~DIN 1809)
	Shank size [mm]:	44.00
	Shank type:	BMT
	Tool adaption:	ER 25 A - u-tec
	Gear ratio [i]:	2:1
	Torque max [Nm]:	32
	Rotation max [1/min]:	3000
	Rotating direction:	opposite
	Coolant:	EXT
	Please note:	Combi bearing
	Center distance [mm]:	72
8 030 45 218	Radial drilling and milling head ER 25 AX UT IC	
	Weight [kg]:	5.040
	Notation:	180° reversible
	Version:	Special
	Tool drive:	Flat (~DIN 1809)
	Shank size [mm]:	44.00
	Shank type:	BMT
	Tool adaption:	ER 25 A - u-tec
	Gear ratio [i]:	2:1
	Torque max [Nm]:	32
	Rotation max [1/min]:	3000
	Rotating direction:	opposite
	Coolant:	IC/Ext
	Pressure max [bar]:	140
	Please note:	Combi bearing
	Center distance [mm]:	72

Part-#	Name	
8 030 45 326	Radial drilling and milling head C 3 IC	
	Notation:	180° reversible
	Tool drive:	Flat (~DIN 1809)
	Shank size [mm]:	44.00
	Shank type:	BMT
	Tool adaption:	heimatec Capto(TM) C 3
	Gear ratio [i]:	1:1
	Torque max [Nm]:	25
	Rotation max [1/min]:	8000
	Rotating direction:	opposite
	Coolant:	IC/Ext
	Pressure max [bar]:	140
	Please note:	Check applicability; note tool length!
	Center distance [mm]:	58
8 030 45 328	Radial drilling and milling head ER 25 AX UT IC	
	Weight [kg]:	4.537
	Notation:	180° reversible
	Tool drive:	Flat (~DIN 1809)
	Shank size [mm]:	44.00
	Shank type:	BMT
	Tool adaption:	ER 25 A - u-tec
	Gear ratio [i]:	1:1
	Torque max [Nm]:	16
	Rotation max [1/min]:	8000
	Rotating direction:	opposite
	Coolant:	IC/Ext
	Pressure max [bar]:	140
	Please note:	stronger bearing
	Center distance [mm]:	75
8 030 45 540	Angle-mill- and drill holder ER 25 AX UT	
	Weight [kg]:	4.190
	Notation:	180° reversible
	Tool drive:	Flat (~DIN 1809)
	Shank size [mm]:	44.00
	Shank type:	BMT
	Tool adaption:	ER 25 A - u-tec
	Gear ratio [i]:	1:1
	Torque max [Nm]:	32
	Rotation max [1/min]:	8000
	Rotating direction:	opposite
	Coolant:	EXT
	Please note:	Combi bearing
	Center distance [mm]:	60
8 030 45 560	Radial drilling and milling head Weldon 3/4"	
	Weight [kg]:	4.420
	Notation:	180° reversible
	Tool drive:	Flat (~DIN 1809)
	Shank size [mm]:	44.00
	Shank type:	BMT
	Tool adaption:	Weldon (DIN 1835 b) 3/4" (19,05mm)
	Gear ratio [i]:	2:1
	Torque max [Nm]:	32
	Rotation max [1/min]:	4000
	Rotating direction:	opposite
	Coolant:	EXT

Part-#	Name
--------	------

Please note: Combi bearing
Center distance [mm]: 60

8 030 45 574



Radial drilling and milling head ER 25 AX UT
Weight [kg]: 3.740
Notation: 180° reversible
Tool drive: Flat (~DIN 1809)
Shank size [mm]: 44.00
Shank type: BMT
Tool adaption: ER 25 A - u-tec
Gear ratio [i]: 1:1
Torque max [Nm]: 32
Rotation max [1/min]: 12000
Rotating direction: opposite
Coolant: EXT
Center distance [mm]: 60

8 030 45 575



Radial drilling and milling head ER 25 AX UT IC
Weight [kg]: 4.600
Notation: 180° reversible
Tool drive: Flat (~DIN 1809)
Shank size [mm]: 44.00
Shank type: BMT
Tool adaption: ER 25 A - u-tec
Gear ratio [i]: 1:1
Torque max [Nm]: 32
Rotation max [1/min]: 12000
Rotating direction: opposite
Coolant: IC/Ext
Pressure max [bar]: 140
Center distance [mm]: 60

8 030 45 609

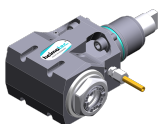



Angle-mill- and drill holder ER 25 AX UT
Weight [kg]: 3.900
Notation: 180° reversible
Tool drive: Flat (~DIN 1809)
Shank size [mm]: 44.00
Shank type: BMT
Tool adaption: ER 25 A - u-tec
Gear ratio [i]: 1:1
Torque max [Nm]: 32
Rotation max [1/min]: 8000
Rotating direction: opposite
Coolant: EXT
Please note: Combi bearing
Center distance [mm]: 60

8 030 45 610



Angle-mill- and drill holder ER 25 AX UT IC
Weight [kg]: 4.240
Notation: 180° reversible
Tool drive: Flat (~DIN 1809)
Shank size [mm]: 44.00
Shank type: BMT
Tool adaption: ER 25 A - u-tec
Gear ratio [i]: 1:1
Torque max [Nm]: 32



Part-#	Name	
	Rotation max [1/min]:	8000
	Rotating direction:	opposite
	Coolant:	IC/Ext
	Pressure max [bar]:	140
	Please note:	Combi bearing
	Center distance [mm]:	60
8 030 46 266	Radial drilling and milling head HT 4	
	Weight [kg]:	4.020
	Notation:	180° reversible
	Tool drive:	Flat (~DIN 1809)
	Shank size [mm]:	44.00
	Shank type:	BMT
	Tool adaption:	HT 4
	Gear ratio [i]:	1:1
	Torque max [Nm]:	32
	Rotation max [1/min]:	12000
	Rotating direction:	opposite
	Coolant:	EXT
	Pressure max [bar]:	140
	Center distance [mm]:	60
8 030 46 267	Radial drilling and milling head HT 4 IC	
	Weight [kg]:	4.250
	Notation:	180° reversible
	Tool drive:	Flat (~DIN 1809)
	Shank size [mm]:	44.00
	Shank type:	BMT
	Tool adaption:	HT 4
	Gear ratio [i]:	1:1
	Torque max [Nm]:	32
	Rotation max [1/min]:	12000
	Rotating direction:	opposite
	Coolant:	IC/Ext
	Pressure max [bar]:	140
	Center distance [mm]:	60
8 030 46 337	Radial drilling and milling head HT 4 IC	
	Weight [kg]:	4.310
	Notation:	180° reversible
	Tool drive:	Flat (~DIN 1809)
	Shank size [mm]:	44.00
	Shank type:	BMT
	Tool adaption:	HT 4
	Gear ratio [i]:	1:1
	Torque max [Nm]:	16
	Rotation max [1/min]:	6000
	Rotating direction:	opposite
	Coolant:	IC/Ext
	Pressure max [bar]:	140
	Please note:	Combi bearing
	Center distance [mm]:	75

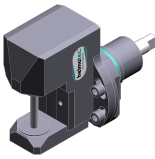

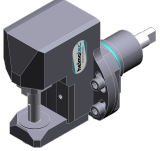
Part-#	Name	
8 030 46 503	Radial drilling and milling head HT 4	
	Weight [kg]:	3.540
	Notation:	180° reversible
	Tool drive:	Flat (~DIN 1809)
	Shank size [mm]:	44.00
	Shank type:	BMT
	Tool adaption:	HT 4
	Gear ratio [i]:	1:1
	Torque max [Nm]:	16
	Rotation max [1/min]:	8000
	Rotating direction:	opposite
	Coolant:	EXT
	Please note:	stronger bearing
	Center distance [mm]:	60
8 030 46 504	Radial drilling and milling head HT 4 IC	
	Weight [kg]:	3.790
	Notation:	180° reversible
	Tool drive:	Flat (~DIN 1809)
	Shank size [mm]:	44.00
	Shank type:	BMT
	Tool adaption:	HT 4
	Gear ratio [i]:	1:1
	Torque max [Nm]:	16
	Rotation max [1/min]:	8000
	Rotating direction:	opposite
	Coolant:	IC/Ext
	Pressure max [bar]:	140
	Please note:	stronger bearing
	Center distance [mm]:	60
8 031 40 000	Radial milling head arbor 5	
	Weight [kg]:	2.480
	Notation:	180° reversible
	Version:	Special
	Tool drive:	Flat (~DIN 1809)
	Shank size [mm]:	44.00
	Shank type:	BMT
	Tool adaption:	Arbor 5
	Gear ratio [i]:	1:1
	Torque max [Nm]:	10
	Rotation max [1/min]:	6000
	Rotating direction:	opposite
	Coolant:	EXT
	Please note:	with interchangeable arbor
	Center distance [mm]:	60
8 031 44 032	Radial polygon head arbor 16	
	Notation:	180° reversible
	Tool drive:	Flat (~DIN 1809)
	Shank size [mm]:	44.00
	Shank type:	BMT
	Tool adaption:	Polygon arbor 16
	Gear ratio [i]:	1:1
	Torque max [Nm]:	32
	Rotation max [1/min]:	8000
	Rotating direction:	opposite
	Coolant:	EXT

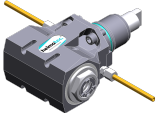
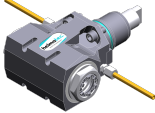

Part-#	Name	
	Please note:	Combi bearing
	Center distance [mm]:	60
8 031 44 046	Radial polygon head arbor 16	
	Weight [kg]:	5.000
	Notation:	180° reversible
	Tool drive:	Flat (~DIN 1809)
	Shank size [mm]:	44.00
	Shank type:	BMT
	Tool adaption:	Polygon arbor 16
	Gear ratio [i]:	2:1
	Torque max [Nm]:	32
	Rotation max [1/min]:	3000
	Rotating direction:	opposite
	Coolant:	EXT
	Please note:	Combi bearing
	Center distance [mm]:	72
8 031 45 040	Radial milling head universal arbor 22	
	Weight [kg]:	4.730
	Notation:	180° reversible
	Tool drive:	Flat (~DIN 1809)
	Shank size [mm]:	44.00
	Shank type:	BMT
	Tool adaption:	Universal arbor 22
	Gear ratio [i]:	2:1
	Torque max [Nm]:	32
	Rotation max [1/min]:	3000
	Rotating direction:	opposite
	Coolant:	EXT
	Please note:	Combi bearing
	Center distance [mm]:	72
8 037 41 000	Radial disk mill head arbor 8	
	Tool drive:	Flat (~DIN 1809)
	Shank size [mm]:	44.00
	Shank type:	BMT
	Tool adaption:	Arbor 8
	Gear ratio [i]:	2:1
	Torque max [Nm]:	32
	Rotation max [1/min]:	4000
	Rotating direction:	opposite
	Coolant:	no
	Center distance [mm]:	78
8 037 42 000	Radial disk mill head arbor 10	
	Weight [kg]:	5.020
	Tool drive:	Flat (~DIN 1809)
	Shank size [mm]:	44.00
	Shank type:	BMT
	Tool adaption:	Arbor 10
	Gear ratio [i]:	2:1
	Torque max [Nm]:	32
	Rotation max [1/min]:	4000
	Rotating direction:	opposite
	Coolant:	no
	Center distance [mm]:	78

Part-#	Name		
	8 037 43 003	Radial disk mill head arbor 13	
		Tool drive:	Flat (~DIN 1809)
		Shank size [mm]:	44.00
		Shank type:	BMT
		Tool adaption:	Arbor 13
		Gear ratio [i]:	2:1
		Torque max [Nm]:	32
		Rotation max [1/min]:	4000
		Rotating direction:	opposite
		Coolant:	no
	Center distance [mm]:	78	
	8 037 44 012	Radial disk mill head arbor 16	
		Weight [kg]:	5.300
		Tool drive:	Flat (~DIN 1809)
		Shank size [mm]:	44.00
		Shank type:	BMT
		Tool adaption:	Arbor 16
		Gear ratio [i]:	2:1
		Torque max [Nm]:	32
		Rotation max [1/min]:	4000
		Rotating direction:	opposite
	Coolant:	no	
	Center distance [mm]:	78	
	8 039 44 032	Radial drilling and milling head ER 16 AX UT	
		Weight [kg]:	3.780
		Notation:	180° reversible
		Version:	double spindle
		Tool drive:	Flat (~DIN 1809)
		Shank size [mm]:	44.00
		Shank type:	BMT
		Tool adaption:	ER 16 A - u-tec
		Gear ratio [i]:	1:1
		Torque max [Nm]:	16
	Rotation max [1/min]:	6000	
	Rotating direction:	same/opposite	
	Coolant:	EXT	
	Please note:	stronger bearing	
	Center distance [mm]:	60	
	8 039 44 058	Radial drilling and milling head ER 16 AX UT	
		Weight [kg]:	4.690
		Notation:	180° reversible
		Employment for:	Main- and sub spindle
		Version:	double spindle
		Tool drive:	Flat (~DIN 1809)
		Shank size [mm]:	44.00
		Shank type:	BMT
		Tool adaption:	ER 16 A - u-tec
		Gear ratio [i]:	1:2
	Torque max [Nm]:	8	
	Rotation max [1/min]:	16000	
	Rotating direction:	same/opposite	
	Coolant:	EXT	
	Please note:	stronger bearing	
	Center distance [mm]:	68,5	

Part-#	Name	
8 039 44 059	Radial drilling and milling head ER 16 AX UT	
	Weight [kg]:	4.660
	Notation:	180° reversible
	Employment for:	Main- and sub spindle
	Version:	double spindle
	Tool drive:	Flat (~DIN 1809)
	Shank size [mm]:	44.00
	Shank type:	BMT
	Tool adaption:	ER 16 A - u-tec
	Gear ratio [i]:	1:3
	Torque max [Nm]:	6
	Rotation max [1/min]:	20000
	Rotating direction:	same/opposite
	Coolant:	EXT
	Please note:	stronger bearing
	Center distance [mm]:	68,5
8 039 44 094	Radial drilling and milling head ER 20 AX UT	
	Weight [kg]:	4.140
	Notation:	180° reversible
	Version:	double spindle
	Tool drive:	Flat (~DIN 1809)
	Shank size [mm]:	44.00
	Shank type:	BMT
	Tool adaption:	ER 20 A - u-tec
	Gear ratio [i]:	1:1
	Torque max [Nm]:	32
	Rotation max [1/min]:	12000
	Rotating direction:	same/opposite
	Coolant:	EXT
	Please note:	stronger bearing
	Center distance [mm]:	60
8 039 45 009	Radial drilling and milling head ER 25 AX UT	
	Weight [kg]:	4.080
	Notation:	180° reversible
	Version:	double spindle
	Tool drive:	Flat (~DIN 1809)
	Shank size [mm]:	44.00
	Shank type:	BMT
	Tool adaption:	ER 25 A - u-tec
	Gear ratio [i]:	1:1
	Torque max [Nm]:	32
	Rotation max [1/min]:	12000
	Rotating direction:	same/opposite
	Coolant:	EXT
	Please note:	stronger bearing
	Center distance [mm]:	60
8 040 43 003	Universal head ± 90° adjustable ER 11 AX	
	Weight [kg]:	3.550
	Tool drive:	Flat (~DIN 1809)
	Shank size [mm]:	44.00
	Shank type:	BMT
	Tool adaption:	ER 11 A
	Gear ratio [i]:	1:1
	Torque max [Nm]:	10

Part-#	Name	
	Rotation max [1/min]:	6000
	Rotating direction:	same
	Coolant:	EXT
	Center distance [mm]:	67
8 040 44 025	Universal head ± 90° adjustable HT 2	
	Weight [kg]:	3.560
	Tool drive:	Flat (~DIN 1809)
	Shank size [mm]:	44.00
	Shank type:	BMT
	Tool adaption:	HT 2
	Gear ratio [i]:	1:1
	Torque max [Nm]:	10
	Rotation max [1/min]:	6000
	Rotating direction:	same
	Coolant:	EXT
	Center distance [mm]:	67
8 040 44 031	Universal head ± 90° adjustable ER 16	
	Weight [kg]:	3.580
	Tool drive:	Flat (~DIN 1809)
	Shank size [mm]:	44.00
	Shank type:	BMT
	Tool adaption:	ER 16
	Gear ratio [i]:	1:1
	Torque max [Nm]:	10
	Rotation max [1/min]:	6000
	Rotating direction:	same
	Coolant:	EXT
	Center distance [mm]:	67
8 040 44 110	Universal head ± 90° adjustable ER 16 AX UT	
	Weight [kg]:	3.800
	Tool drive:	Flat (~DIN 1809)
	Shank size [mm]:	44.00
	Shank type:	BMT
	Tool adaption:	ER 16 A - u-tec
	Gear ratio [i]:	1:1
	Torque max [Nm]:	16
	Rotation max [1/min]:	12000
	Rotating direction:	same
	Coolant:	EXT
	Center distance [mm]:	58
8 040 44 111	Universal head ± 90° adjustable ER 16 AX UT IC	
	Weight [kg]:	3.040
	Tool drive:	Flat (~DIN 1809)
	Shank size [mm]:	44.00
	Shank type:	BMT
	Tool adaption:	ER 16 A - u-tec
	Gear ratio [i]:	1:1
	Torque max [Nm]:	16
	Rotation max [1/min]:	12000
	Rotating direction:	same
	Coolant:	IC/Ext
	Pressure max [bar]:	140
	Center distance [mm]:	58

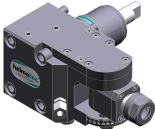
Part-#	Name	
8 040 44 116	Universal head ± 90° adjustable ER 16 AX UT	
	Tool drive:	Flat (~DIN 1809)
	Shank size [mm]:	44.00
	Shank type:	BMT
	Tool adaption:	ER 16 A - u-tec
	Gear ratio [i]:	1:2
	Torque max [Nm]:	8
	Rotation max [1/min]:	20000
	Rotating direction:	same
	Coolant:	EXT
	Pressure max [bar]:	140
	Center distance [mm]:	58
8 040 44 117	Universal head ± 90° adjustable ER 16 AX UT IC	
	Tool drive:	Flat (~DIN 1809)
	Shank size [mm]:	44.00
	Shank type:	BMT
	Tool adaption:	ER 16 A - u-tec
	Gear ratio [i]:	1:2
	Torque max [Nm]:	8
	Rotation max [1/min]:	20000
	Rotating direction:	same
	Coolant:	IC/Ext
	Pressure max [bar]:	140
	Center distance [mm]:	58
8 043 43 000	Universal head + 90° adj. ER11 AX	
	Weight [kg]:	4.040
	Notation:	offset
	Tool drive:	Flat (~DIN 1809)
	Shank size [mm]:	44.00
	Shank type:	BMT
	Tool adaption:	ER 11 A
	Gear ratio [i]:	1:1
	Torque max [Nm]:	10
	Rotation max [1/min]:	6000
	Rotating direction:	opposite
	Coolant:	EXT
	Please note:	180° reversible
	Center distance [mm]:	25
	Offset [mm]:	72
8 043 43 001	Universal head +155° adj. ER11 AX	
	Weight [kg]:	4.200
	Notation:	offset; 180° reversible
	Tool drive:	Flat (~DIN 1809)
	Shank size [mm]:	44.00
	Shank type:	BMT
	Tool adaption:	ER 11 A
	Gear ratio [i]:	1:2
	Torque max [Nm]:	5
	Rotation max [1/min]:	12000
	Rotating direction:	opposite
	Coolant:	EXT
	Center distance [mm]:	25
	Offset [mm]:	74

Part-#	Name	
8 043 43 004	Universal head +155° adj. ER11 AX IC	
	Weight [kg]:	4.500
	Notation:	offset; 180° reversible
	Tool drive:	Flat (~DIN 1809)
	Shank size [mm]:	44.00
	Shank type:	BMT
	Tool adaption:	ER 11 A
	Gear ratio [i]:	1:2
	Torque max [Nm]:	5
	Rotation max [1/min]:	12000
	Rotating direction:	opposite
	Coolant:	IC/Ext
	Pressure max [bar]:	25
	Center distance [mm]:	25
	Offset [mm]:	74
8 043 44 001	Universal head + 90° adjustable ER 16	
	Weight [kg]:	4.070
	Notation:	offset
	Tool drive:	Flat (~DIN 1809)
	Shank size [mm]:	44.00
	Shank type:	BMT
	Tool adaption:	ER 16
	Gear ratio [i]:	1:1
	Torque max [Nm]:	10
	Rotation max [1/min]:	6000
	Rotating direction:	opposite
	Coolant:	EXT
	Please note:	180° reversible
	Center distance [mm]:	25
	Offset [mm]:	72
8 043 44 051	Universal head + 60°/- 5° adj. ER16AX UT	
	Weight [kg]:	3.640
	Notation:	offset
	Tool drive:	Flat (~DIN 1809)
	Shank size [mm]:	44.00
	Shank type:	BMT
	Tool adaption:	ER 16 A - u-tec
	Gear ratio [i]:	1:1
	Torque max [Nm]:	16
	Rotation max [1/min]:	12000
	Rotating direction:	opposite
	Coolant:	EXT
	Please note:	180° reversible
	Center distance [mm]:	25
	Offset [mm]:	50
8 043 44 052	Universal head + 60°/- 5° adj. ER16AX UTIK	
	Notation:	offset
	Tool drive:	Flat (~DIN 1809)
	Shank size [mm]:	44.00
	Shank type:	BMT
	Tool adaption:	ER 16 A - u-tec
	Gear ratio [i]:	1:1
	Torque max [Nm]:	16
	Rotation max [1/min]:	12000

Part-#	Name	
	Rotating direction:	opposite
	Coolant:	IC/Ext
	Pressure max [bar]:	140
	Please note:	180° reversible
	Center distance [mm]:	25
	Offset [mm]:	50
8 050 44 010	Multispindle drilling head ER 16 AX UT	
	Notation:	offset
	Version:	3-spindles
	Tool drive:	Flat (~DIN 1809)
	Shank size [mm]:	44.00
	Shank type:	BMT
	Tool adaption:	ER 16 A - u-tec
	Gear ratio [i]:	1:1
	Torque max [Nm]:	25
	Rotation max [1/min]:	6000
	Rotating direction:	same
	Coolant:	EXT
	Please note:	2xER 16 A UT offset, 1x centered
8 050 44 011	Multispindle drilling head ER 16 AX UT	
	Weight [kg]:	3.810
	Notation:	offset; 180° reversible
	Version:	2-spindles in short version
	Tool drive:	Flat (~DIN 1809)
	Shank size [mm]:	44.00
	Shank type:	BMT
	Tool adaption:	ER 16 A - u-tec
	Gear ratio [i]:	1:1
	Torque max [Nm]:	20
	Rotation max [1/min]:	6000
	Rotating direction:	same
	Coolant:	EXT
	Offset [mm]:	50
8 050 44 018	Multispindle drilling head ER 16 AX UT	
	Weight [kg]:	4.830
	Notation:	offset; 180° reversible
	Version:	2-spindles
	Tool drive:	Flat (~DIN 1809)
	Shank size [mm]:	44.00
	Shank type:	BMT
	Tool adaption:	ER 16 A - u-tec
	Gear ratio [i]:	1:2
	Torque max [Nm]:	8
	Rotation max [1/min]:	12000
	Rotating direction:	same
	Coolant:	EXT
	Offset [mm]:	50

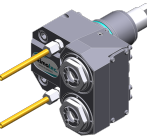
Part-#	Name		
	8 050 44 019	Multispindle drilling head ER 16 AX UT	
		Notation:	offset; 180° reversible
		Version:	2-spindles
		Tool drive:	Flat (~DIN 1809)
		Shank size [mm]:	44.00
		Shank type:	BMT
		Tool adaption:	ER 16 A - u-tec
		Gear ratio [i]:	1:1
		Torque max [Nm]:	25
		Rotation max [1/min]:	6000
		Rotating direction:	same
		Coolant:	EXT
		Offset [mm]:	50
	8 050 44 021	Multispindle drilling head ER 16 AX UT	
		Weight [kg]:	3.770
		Notation:	offset; 180° reversible
		Version:	2-spindles in short version
		Tool drive:	Flat (~DIN 1809)
		Shank size [mm]:	44.00
		Shank type:	BMT
		Tool adaption:	ER 16 A - u-tec
		Gear ratio [i]:	1:2
		Torque max [Nm]:	8
		Rotation max [1/min]:	12000
		Rotating direction:	same
		Coolant:	EXT
	Offset [mm]:	50	
	8 050 44 024	Multispindle drilling head ER 16 AX UT IC	
		Weight [kg]:	4.840
		Notation:	offset; 180° reversible
		Version:	2-spindles
		Tool drive:	Flat (~DIN 1809)
		Shank size [mm]:	44.00
		Shank type:	BMT
		Tool adaption:	ER 16 A - u-tec
		Gear ratio [i]:	1:2
		Torque max [Nm]:	8
		Rotation max [1/min]:	12000
		Rotating direction:	same
		Coolant:	IC/Ext
	Pressure max [bar]:	25	
	Offset [mm]:	50	
	8 050 44 069	Multispindle drilling head ER 16 AX UT	
		Weight [kg]:	4.060
		Notation:	offset; 180° reversible
		Version:	2-spindles
		Tool drive:	Flat (~DIN 1809)
		Shank size [mm]:	44.00
		Shank type:	BMT
		Tool adaption:	ER 16 A - u-tec
		Gear ratio [i]:	1:1
		Torque max [Nm]:	32/Sp.
		Rotation max [1/min]:	12000
		Rotating direction:	same

Part-#	Name
--------	------

Coolant: EXT
Offset [mm]: 50

8 050 44 070



Multispindle drilling head ER 16 AX UT IC
Weight [kg]: 4.150
Notation: offset; 180° reversible
Tool drive: Flat (~DIN 1809)
Shank size [mm]: 44.00
Shank type: BMT
Tool adaption: ER 16 A - u-tec
Gear ratio [i]: 1:1
Torque max [Nm]: 32/Sp.
Rotation max [1/min]: 12000
Rotating direction: same
Coolant: IC/Ext
Pressure max [bar]: 140
Offset [mm]: 50

8 050 44 071

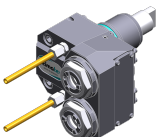

Multispindle drilling head ER 20 AX UT
Weight [kg]: 4.160
Notation: offset; 180° reversible
Tool drive: Flat (~DIN 1809)
Shank size [mm]: 44.00
Shank type: BMT
Tool adaption: ER 20 A - u-tec
Gear ratio [i]: 1:1
Torque max [Nm]: 32/Sp.
Rotation max [1/min]: 12000
Rotating direction: same
Coolant: EXT
Offset [mm]: 50

8 053 44 068



Multispindle radial head ER 16 AX UT
Notation: 180° reversible
Version: 2-spindles
Tool drive: Flat (~DIN 1809)
Shank size [mm]: 44.00
Shank type: BMT
Tool adaption: ER 16 A - u-tec
Gear ratio [i]: 1:1
Torque max [Nm]: 32/Sp
Rotation max [1/min]: 12000
Rotating direction: same
Coolant: EXT
Pressure max [bar]: 140
Center distance [mm]: 60

8 053 44 070

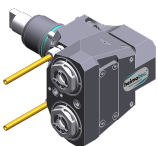



Multispindle radial head ER 16 AX UT
Weight [kg]: 5.600
Notation: 180° reversible
Version: 2-spindles
Tool drive: Flat (~DIN 1809)
Shank size [mm]: 44.00
Shank type: BMT
Tool adaption: ER 16 A - u-tec
Gear ratio [i]: 1:2

Part-#	Name	
	Torque max [Nm]:	16/Sp
	Rotation max [1/min]:	24000
	Rotating direction:	same
	Coolant:	EXT
	Center distance [mm]:	60
8 053 44 071	Multispindle radial head ER 16 AX UTIK	
	Weight [kg]:	5.600
	Notation:	180° reversible
	Version:	2-spindles
	Tool drive:	Flat (~DIN 1809)
	Shank size [mm]:	44.00
	Shank type:	BMT
	Tool adaption:	ER 16 A - u-tec
	Gear ratio [i]:	1:2
	Torque max [Nm]:	16/Sp
	Rotation max [1/min]:	24000
	Rotating direction:	same
	Coolant:	IC/Ext
	Pressure max [bar]:	140
	Center distance [mm]:	60
8 068 44 000	Radial whirling unit HW 46	
	Weight [kg]:	4.960
	Notation:	180° reversible
	Tool drive:	Flat (~DIN 1809)
	Shank size [mm]:	44.00
	Shank type:	BMT
	Tool adaption:	HW 46
	Gear ratio [i]:	1:1
	Torque max [Nm]:	16
	Rotation max [1/min]:	8000
	Rotating direction:	same
	Coolant:	no
	Please note:	without cutting inserts carrier
	Center distance [mm]:	63
8 200 03 011	Cover plate	
	Weight [kg]:	0.214
	Shank type:	BMT
8 202 10 005	Basic holder longitudinal seat FN 12	
	Weight [kg]:	0.720
	Notation:	180° reversible
	Shank type:	BMT
	Machine adaption:	Centering key b 20
	Tool adaption:	Interface FN 12
	Coolant:	EXT
8 209 48 001	Adapter for sensor Renishaw RLP	
	Weight [kg]:	0.980
	Notation:	180° reversible
	Shank size [mm]:	44.00
	Shank type:	BMT
	Coolant:	no





Part-#	Name	
8 224 11 012	Cut-off holder sq. 20	
	Weight [kg]:	0.920
	Employment for:	right cutting tools
	Version:	Edge on side of turret
	Shank type:	BMT
	Machine adaption:	Centering key b 20
	Tool adaption:	Sq. 20
	Coolant:	EXT
8 224 11 013	Cut-off holder sq. 20	
	Weight [kg]:	0.890
	Employment for:	left cutting tools
	Version:	Edge on center of turret
	Shank type:	BMT
	Machine adaption:	Centering key b 20
	Tool adaption:	Sq. 20
	Coolant:	EXT
8 224 11 014	Turning holder sq. 3/4"	
	Employment for:	left cutting tools
	Version:	Edge on center of turret
	Shank type:	BMT
	Machine adaption:	Centering key b 20
	Tool adaption:	Sq. 3/4" (19,05mm)
	Coolant:	EXT
8 224 11 015	Cut-off holder sq. 3/4"	
	Weight [kg]:	0.900
	Employment for:	right cutting tools
	Version:	Edge on side of turret
	Shank type:	BMT
	Machine adaption:	Centering key b 20
	Tool adaption:	Sq. 3/4" (19,05mm)
	Coolant:	EXT
8 224 12 008	Cut-off holder SH 26	
	Weight [kg]:	1.010
	Employment for:	Cut-off tool 26
	Version:	Clampshaft on turret center
	Shank type:	BMT
	Machine adaption:	Centering key b 20
	Tool adaption:	Clampshaft SH 26
	Coolant:	EXT
8 224 12 009	Cut-off holder SH 26	
	Weight [kg]:	1.120
	Employment for:	for cut-off tool 26
	Version:	Clampshaft on turret side
	Shank type:	BMT
	Machine adaption:	Centering key b 20
	Tool adaption:	Clampshaft SH 26
	Coolant:	EXT

Part-#	Name	
8 224 13 006	Cut-off holder SH 32	
	Weight [kg]:	0.800
	Employment for:	Cut-off tool 32
	Version:	Clampshaft on turret center
	Shank type:	BMT
	Machine adaption:	Centering key b 20
	Tool adaption:	Clampshaft SH 32
	Coolant:	EXT
8 224 14 007	Universal turning holder sq. 20	
	Weight [kg]:	2.030
	Notation:	180° reversible
	Shank type:	BMT
	Machine adaption:	Centering key b 20
	Tool adaption:	Sq. 20
		Sq. 20
	Coolant:	EXT
8 224 14 008	Universal turning holder sq. 3/4"	
	Weight [kg]:	1.970
	Notation:	180° reversible
	Shank type:	BMT
	Machine adaption:	Centering key b 20
	Tool adaption:	Sq. 3/4" (19,05mm)
		Sq. 3/4" (19,05mm)
	Coolant:	EXT
8 224 14 017	Universal turning holder sq. 20	
	Notation:	180° reversible
	Version:	short
	Shank type:	BMT
	Machine adaption:	Centering key b 20
	Tool adaption:	Sq. 20
		Sq. 20
	Coolant:	EXT
8 224 14 024	Universal turning holder sq. 20 IC	
	Weight [kg]:	1.970
	Notation:	180° reversible
	Shank type:	BMT
	Machine adaption:	Centering key b 20
	Tool adaption:	Sq. 20
		Sq. 20
	Coolant:	IC/Ext
	Pressure max [bar]:	100
	Please note:	Key rail
8 224 14 030	Universal turning holder sq. 3/4" IC	
	Weight [kg]:	1.700
	Notation:	180° reversible
	Shank type:	BMT
	Machine adaption:	Centering key b 20
	Tool adaption:	Sq. 3/4" (19,05mm)
		Sq. 3/4" (19,05mm)
	Coolant:	IC/Ext
	Pressure max [bar]:	100

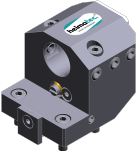

Part-#	Name	
	Please note:	Key rail
8 225 11 006	Cut-off holder sq. 20	
	Weight [kg]:	0.900
	Employment for:	left cutting tools
	Version:	Edge on side of turret
	Shank type:	BMT
	Machine adaption:	Centering key b 20
	Tool adaption:	Sq. 20
	Coolant:	EXT
8 225 11 007	Cut-off holder sq. 20	
	Weight [kg]:	0.900
	Employment for:	right cutting tools
	Version:	Edge on center of turret
	Shank type:	BMT
	Machine adaption:	Centering key b 20
	Tool adaption:	Sq. 20
	Coolant:	EXT
8 225 11 008	Cut-off holder sq. 3/4"	
	Weight [kg]:	0.910
	Employment for:	left cutting tools
	Version:	Edge on side of turret
	Shank type:	BMT
	Machine adaption:	Centering key b 20
	Tool adaption:	Sq. 3/4" (19,05mm)
	Coolant:	EXT
8 229 15 006	Tool holder C 3 IC	
	Weight [kg]:	1.880
	Notation:	180° reversible
	Version:	right
	Shank type:	BMT
	Machine adaption:	Centering key b 20
	Tool adaption:	heimatec Capto(TM) C 3
	Coolant:	IC
	Please note:	Check applicability, tool length check!
	Offset [mm]:	45
8 240 15 007	Insert drill holder 16 IC	
	Weight [kg]:	4.540
	Notation:	180° reversible
	Shank type:	BMT
	Tool adaption:	Whistle-Notch (DIN 1835 E) 16
	Coolant:	IC
	Center distance [mm]:	75
8 240 15 011	Collet chuck holder ER 25	
	Weight [kg]:	1.910
	Notation:	180° reversible
	Shank type:	BMT
	Machine adaption:	Centering key b 20
	Tool adaption:	ER 25
	Coolant:	IC/Ext
	Center distance [mm]:	60



Part-#	Name	
8 240 15 024	Collet chuck holder ER 25 AX UT	
	Notation:	180° reversible
	Shank type:	BMT
	Machine adaption:	Centering key b 20
	Tool adaption:	ER 25 A - u-tec
	Coolant:	IC/Ext
	Center distance [mm]:	75
8 240 15 025	Collet chuck holder ER 25 AX UT	
	Weight [kg]:	2.100
	Notation:	180° reversible
	Shank type:	BMT
	Machine adaption:	Centering key b 20
	Tool adaption:	ER 25 A - u-tec
	Coolant:	IC/Ext
	Center distance [mm]:	60
8 240 15 042	Tool holder C 3 IC	
	Weight [kg]:	2.300
	Notation:	180° reversible
	Version:	offset; right
	Shank type:	BMT
	Machine adaption:	Centering key b 20
	Tool adaption:	heimatec Capto(TM) C 3
	Coolant:	IC
	Please note:	Check applicability; note tool length!
	Center distance [mm]:	70
8 240 15 043	Tool holder C 3 IC	
	Weight [kg]:	2.470
	Notation:	180° reversible
	Version:	right
	Shank type:	BMT
	Machine adaption:	Centering key b 20
	Tool adaption:	heimatec Capto(TM) C 3
	Coolant:	IC
	Please note:	Check applicability; note tool length
	Center distance [mm]:	70
8 240 16 007	Boring bar holder Ø 20	
	Weight [kg]:	2.130
	Notation:	180° reversible
	Shank type:	BMT
	Machine adaption:	Centering key b 20
	Tool adaption:	Ø 20
	Coolant:	IC/Ext
	Center distance [mm]:	75
8 240 16 068	Tool holder C 4 IC	
	Notation:	180° reversible
	Version:	offset; right
	Shank type:	BMT
	Machine adaption:	Centering key b 20
	Tool adaption:	heimatec Capto(TM) C 4
	Coolant:	IC
	Pressure max [bar]:	100

Part-#	Name	
	Please note: Center distance [mm]:	Check applicability; note tool length! 75
8 240 17 009	Boring bar holder Ø 25	
	Weight [kg]: Machine adaption: Tool adaption: Coolant: Center distance [mm]:	1.740 Centering key b 20 Ø 25 IC/Ext 60
8 240 17 020	Boring bar holder Ø 25	
	Weight [kg]: Notation: Shank type: Machine adaption: Tool adaption: Coolant: Center distance [mm]:	2.050 180° reversible BMT Centering key b 20 Ø 25 IC/Ext 75
8 240 17 029	Boring bar holder Ø 1"	
	Weight [kg]: Notation: Shank type: Machine adaption: Tool adaption: Coolant: Center distance [mm]:	2.050 180° reversible BMT Centering key b 20 Ø 1" (25,4mm) IC/Ext 75
8 240 17 083	Boring bar holder Ø 25	
	Notation: Version: Shank type: Machine adaption: Tool adaption: Coolant: Please note: Center distance [mm]:	180° reversible special offset BMT Centering key b 20 Ø 25 IC/Ext Tool holder on turret center 60
8 240 17 086	Boring bar holder Ø 25	
	Weight [kg]: Notation: Version: Shank type: Machine adaption: Tool adaption: Coolant: Please note: Center distance [mm]:	3.540 180° reversible offset BMT Centering key b 20 Ø 25 IC/Ext Tool adaption on turret center 75

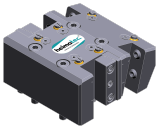

Part-#	Name	
8 240 18 025	Boring bar holder Ø 32	
	Weight [kg]:	3.610
	Notation:	180° reversible
	Version:	offset
	Shank type:	BMT
	Machine adaption:	Centering key b 20
	Tool adaption:	Ø 32
	Coolant:	IC/Ext
	Please note:	Tool adaption to turret center
	Center distance [mm]:	75
8 240 18 027	Boring bar holder Ø 32	
	Weight [kg]:	2.900
	Notation:	180° reversible
	Version:	offset
	Shank type:	BMT
	Machine adaption:	Centering key b 20
	Tool adaption:	Ø 32
	Coolant:	IC/Ext
	Please note:	Tool holder on turret center
	Center distance [mm]:	60
8 240 18 048	Boring bar holder Ø 1 1/4 "	
	Weight [kg]:	2.750
	Notation:	180° reversible
	Version:	offset
	Shank type:	BMT
	Machine adaption:	Centering key b 20
	Tool adaption:	Ø 1 1/4" (31,75mm)
	Coolant:	IC/Ext
	Please note:	Tool holder on turret center
	Center distance [mm]:	60
8 240 18 052	Boring bar holder Ø 1 1/4 "	
	Weight [kg]:	3.140
	Notation:	180° reversible
	Shank type:	BMT
	Machine adaption:	Centering key b 20
	Tool adaption:	Ø 1 1/4" (31,75mm)
	Coolant:	IC/Ext
	Center distance [mm]:	75
8 240 18 076	Boring bar holder Ø 32	
	Weight [kg]:	3.400
	Notation:	180° reversible
	Version:	offset
	Shank type:	BMT
	Machine adaption:	Centering key b 20
	Tool adaption:	Ø 32
	Coolant:	IC/Ext
	Please note:	Tool adaption on turret center
	Center distance [mm]:	75

Part-#	Name	
8 244 11 003	Facing holder sq. 20	
	Weight [kg]:	2.550
	Notation:	180° reversible
	Shank type:	BMT
	Machine adaption:	Centering key b 20
	Tool adaption:	Sq. 20
	Coolant:	EXT
8 244 11 006	Facing holder sq. 3/4"	
	Weight [kg]:	2.460
	Notation:	180° reversible
	Shank type:	BMT
	Machine adaption:	Centering key b 20
	Tool adaption:	Sq. 3/4" (19,05mm)
	Coolant:	EXT
8 249 15 008	Double collet chuck holder ER 25 AX UT	
	Weight [kg]:	3.110
	Notation:	180° reversible
	Shank type:	BMT
	Machine adaption:	Centering key b 20
	Tool adaption:	ER 25 A - u-tec
	Coolant:	IC/Ext
	Center distance [mm]:	75
8 249 15 014	Double tool holder C 3 IC	
	Weight [kg]:	3.500
	Notation:	180° reversible
	Employment for:	Main- and sub spindle
	Shank type:	BMT
	Machine adaption:	Centering key b 20
	Tool adaption:	heimatec Capto(TM) C 3 heimatec Capto(TM) C 3
	Coolant:	IC
	Please note:	Check applicability!; note tool length!
	Center distance [mm]:	70
8 251 11 004	Double turning holder sq. 20	
	Weight [kg]:	3.250
	Notation:	180° reversible
	Employment for:	right cutting tools
	Shank type:	BMT
	Machine adaption:	Centering key b 20
	Tool adaption:	Sq. 20 Sq. 20
	Coolant:	EXT
8 251 11 005	Double turning holder sq. 16	
	Weight [kg]:	3.360
	Notation:	180° reversible
	Shank type:	BMT
	Machine adaption:	Centering key b 20
	Tool adaption:	Sq. 16
	Coolant:	EXT

Part-#	Name	
8 251 11 008	Double turning holder sq. 3/4"	
	Weight [kg]:	3.240
	Notation:	180° reversible
	Employment for:	right cutting tools
	Shank type:	BMT
	Machine adaption:	Centering key b 20
	Tool adaption:	Sq. 3/4" (19,05mm)
		Sq. 3/4" (19,05mm)
	Coolant:	EXT
8 251 13 020	Combi multiple holder 3x sq. 3/4" IC	
	Weight [kg]:	2.280
	Shank type:	BMT
	Machine adaption:	Centering key b 20
	Tool adaption:	Sq. 3/4" (19,05mm)
		Sq. 3/4" (19,05mm)
	Coolant:	IC/Ext
	Pressure max [bar]:	100
	Please note:	Key rail
8 251 13 025	Combi multiple holder 3x sq. 3/4"	
	Weight [kg]:	2.100
	Employment for:	Main- and sub spindle
	Shank type:	BMT
	Machine adaption:	Centering key b 20
	Tool adaption:	Sq. 3/4" (19,05mm)
		Sq. 3/4" (19,05mm)
	Coolant:	EXT
8 251 13 026	Combi multiple holder 6x sq. 3/4" IC	
	Weight [kg]:	3.400
	Employment for:	Main- and sub spindle
	Shank type:	BMT
	Machine adaption:	Centering key b 20
	Tool adaption:	Sq. 3/4"
		Sq. 3/4"
		Sq. 3/4"
		Sq. 3/4"
	Coolant:	IC/Ext
	Pressure max [bar]:	100
	Please note:	Key rail
8 251 14 008	Combi multiple holder 6x sq. 20	
	Weight [kg]:	3.660
	Employment for:	Main- and sub spindle
	Shank type:	BMT
	Machine adaption:	Centering key b 20
	Tool adaption:	Sq. 20
		Sq. 20
		Sq. 20
		Sq. 20
	Coolant:	EXT



Part-#	Name	
8 251 14 010	Combi multiple holder 3x sq. 20	
	Weight [kg]:	2.390
	Shank type:	BMT
	Machine adaption:	Centering key b 20
	Tool adaption:	Sq. 20 Sq. 20
	Coolant:	EXT
8 251 14 014	Combi multiple holder 6x sq. 3/4"	
	Weight [kg]:	3.690
	Employment for:	Main- and sub spindle
	Shank type:	BMT
	Machine adaption:	Centering key b 20
	Tool adaption:	Sq. 3/4" (19,05mm) Sq. 3/4" (19,05mm) Sq. 3/4" (19,05mm) Sq. 3/4" (19,05mm)
	Coolant:	EXT
8 251 14 076	Combi multiple holder 6x sq. 20 IC	
	Weight [kg]:	3.620
	Employment for:	Main- and sub spindle
	Shank type:	BMT
	Machine adaption:	Centering key b 20
	Tool adaption:	Sq. 20 Sq. 20 Sq. 20 Sq. 20
	Coolant:	IC/Ext
	Pressure max [bar]:	100
	Please note:	Key rail
8 251 14 077	Combi multiple holder 3x sq. 20 IC	
	Weight [kg]:	2.270
	Shank type:	BMT
	Machine adaption:	Centering key b 20
	Tool adaption:	Sq. 20 Sq. 20
	Coolant:	IC/Ext
	Pressure max [bar]:	100
	Please note:	Key rail
8 251 14 099	Combi double turning holder sq. 20 IC	
	Weight [kg]:	3.140
	Notation:	180° reversible
	Shank type:	BMT
	Machine adaption:	Centering key b 20
	Tool adaption:	Sq. 20 Sq. 20 Sq. 20 Sq. 20
	Coolant:	IC/Ext
	Pressure max [bar]:	100
	Please note:	Key rail

Part-#	Name	
8 251 14 106	Combi multiple holder 3x sq. 20 IC	
	Weight [kg]:	2.160
	Shank type:	BMT
	Machine adaption:	Centering key b 20
	Tool adaption:	Sq. 20
		Sq. 20
	Coolant:	IC/Ext
	Pressure max [bar]:	100
	Please note:	Key rail
8 251 14 107	Combi multiple holder 6x sq. 20 IC	
	Weight [kg]:	3.280
	Employment for:	Main- and sub spindle
	Shank type:	BMT
	Machine adaption:	Centering key b 20
	Tool adaption:	Sq. 20
		Sq. 20
		Sq. 20
		Sq. 20
	Coolant:	IC/Ext
	Pressure max [bar]:	100
	Please note:	Key rail
8 251 15 036	Multiple tool holder C 3 IC	
	Weight [kg]:	2.340
	Version:	right
	Shank type:	BMT
	Machine adaption:	Centering key b 20
	Tool adaption:	heimatec Capto(TM) C 3
		heimatec Capto(TM) C 3 - 15°
	Coolant:	IC
	Please note:	Check applicability; note tool length
	Offset [mm]:	45
8 253 14 005	Multiple collet chuck holder ER 16 AX UT	
	Weight [kg]:	3.800
	Notation:	180° reversible
	Employment for:	Main- and sub spindle
	Shank type:	BMT
	Machine adaption:	Centering key b 20
	Tool adaption:	ER 16 A - u-tec/2x ER 16 A - u-tec - 15°
		ER 16 A - u-tec/2x ER 16 A - u-tec - 15°
	Coolant:	IC/Ext
	Center distance [mm]:	75
8 253 15 002	Multiple tool holder C 3 IC	
	Weight [kg]:	3.680
	Version:	right
	Shank type:	BMT
	Machine adaption:	Centering key b 20
	Tool adaption:	heimatec Capto(TM) C 3
	Coolant:	IC
	Please note:	Check applicability, note tool length!
	Center distance [mm]:	70

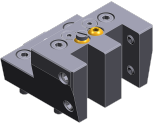
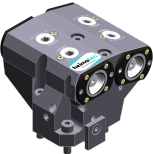
Part-#	Name	
8 253 15 004	Multiple boring bar holder 3x Ø 16	
	Weight [kg]:	3.330
	Notation:	180° reversible
	Shank type:	BMT
	Machine adaption:	Centering key b 20
	Tool adaption:	Ø 16
		Ø 16
	Coolant:	IC/Ext
	Center distance [mm]:	56/80
8 253 15 020	Multiple tool holder C 3 IC	
	Weight [kg]:	3.450
	Version:	offset, right
	Shank type:	BMT
	Machine adaption:	Centering key b 20
	Tool adaption:	heimatec Capto(TM) C 3
	Coolant:	IC
	Please note:	Check applicability, note tool length!
	Center distance [mm]:	70
8 253 17 020	Multiple boring bar holder 2x Ø 25	
	Weight [kg]:	3.290
	Notation:	180° reversible
	Shank type:	BMT
	Machine adaption:	Centering key b 20
	Tool adaption:	Ø 25
		Ø 25 - 15°
	Coolant:	IC/Ext
	Center distance [mm]:	75
8 253 17 033	Multiple boring bar holder 2x Ø 1"	
	Weight [kg]:	3.270
	Notation:	180° reversible
	Shank type:	BMT
	Machine adaption:	Centering key b 20
	Tool adaption:	Ø 1" (25,4mm)
		Ø 1" (25,4mm) - 15°
	Coolant:	IC/Ext
	Center distance [mm]:	75
8 253 17 037	Multiple boring bar holder 2x Ø 25	
	Weight [kg]:	3.590
	Version:	Special
	Shank type:	BMT
	Machine adaption:	Centering key b 20
	Tool adaption:	Ø 25
		Ø 25 - 15°
	Coolant:	IC/Ext
	Center distance [mm]:	80

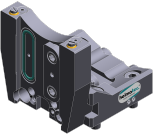
Part-#	Name	
8 254 11 000	Multiple facing holder 3x sq. 20	
	Weight [kg]:	3.370
	Employment for:	Main- and sub spindle
	Shank type:	BMT
	Machine adaption:	Centering key b 20
	Tool adaption:	Sq. 20 Sq. 20 - 15° Sq. 20 - 15°
	Coolant:	EXT
	Center distance [mm]:	70
8 254 11 001	Multiple facing holder 3x sq. 12	
	Weight [kg]:	3.820
	Employment for:	Main- and sub spindle
	Version:	Special
	Shank type:	BMT
	Machine adaption:	Centering key b 20
	Tool adaption:	Sq. 12 Sq. 12
	Coolant:	EXT
	Center distance [mm]:	78
8 254 14 000	Multiple facing holder 3x sq. 20	
	Weight [kg]:	3.580
	Employment for:	Main- and sub spindle
	Shank type:	BMT
	Machine adaption:	Centering key b 20
	Tool adaption:	Sq. 20 Sq. 20
	Coolant:	EXT
	Center distance [mm]:	70
8 259 11 002	Multiple turning holder 2x sq. 20	
	Weight [kg]:	2.080
	Notation:	180° reversible
	Version:	Y-axes offset
	Shank type:	BMT
	Machine adaption:	Centering key b 20
	Tool adaption:	Sq. 20 Sq. 20
	Coolant:	EXT
8 259 15 015	Multiple tool holder C 3 IC	
	Weight [kg]:	5.880
	Employment for:	Main- and sub spindle
	Version:	right
	Shank type:	BMT
	Machine adaption:	Centering key b 20
	Tool adaption:	heimatec Capto(TM) C 3 heimatec Capto(TM) C 3
	Coolant:	IC
	Please note:	Check applicability, note tool length!
	Center distance [mm]:	70

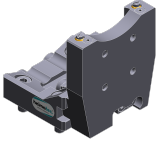
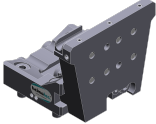
Part-#	Name	
8 259 19 005	Multiple holder Ø 25 and sq. 20	
	Weight [kg]:	3.980
	Notation:	180° reversible
	Employment for:	Main- and sub spindle
	Shank type:	BMT
	Machine adaption:	Centering key b 20
	Tool adaption:	Sq. 20
		Sq. 20
		Sq. 20
		Sq. 20
	Coolant:	IC/Ext
	Center distance [mm]:	75
8 261 18 006	Tool holder for centering insert	
	Weight [kg]:	2.600
	Notation:	180° reversible
	Shank type:	BMT
	Machine adaption:	Centering key slot b 20
	Tool adaption:	Ø 32
	Coolant:	EXT
	Please note:	Price without centering point
	Center distance [mm]:	60
8 320 12 007	Cut-off holder, height adjustable SH 26 IC	
	Weight [kg]:	1.230
	Notation:	180° reversible
	Shank type:	BMT
	Machine adaption:	Centering key b 20
	Tool adaption:	Clampshaft SH 26
	Coolant:	IC/Ext
	Pressure max [bar]:	70
8 320 12 008	Cut-off holder, height adjustable SH 26 IC	
	Weight [kg]:	1.380
	Notation:	180° reversible
	Shank type:	BMT
	Machine adaption:	Centering key b 20
	Tool adaption:	Clampshaft SH 26
	Coolant:	IC/Ext
	Pressure max [bar]:	70
	Please note:	Clampshaft internal
8 320 13 003	Cut-off holder, height adjustable SH 32 IC	
	Weight [kg]:	1.300
	Notation:	180° reversible
	Shank type:	BMT
	Machine adaption:	Centering key b 20
	Tool adaption:	Clampshaft SH 32
	Coolant:	IC/Ext
	Pressure max [bar]:	70

Part-#	Name	
8 320 13 013	Cut-off holder, height adjustable SH 32 IC	
	Weight [kg]:	1.580
	Notation:	180° reversible
	Shank type:	BMT
	Machine adaption:	Centering key b 20
	Tool adaption:	Clampshaft SH 32
	Coolant:	IC/Ext
	Pressure max [bar]:	70
	Please note:	with offset cut-off tool holder; use
8 320 13 014	Cut-off holder, height adjustable SH 32 IC	
	Weight [kg]:	1.490
	Notation:	180° reversible
	Shank type:	BMT
	Machine adaption:	Centering key b 20
	Tool adaption:	Clampshaft SH 32
	Coolant:	IC/Ext
	Pressure max [bar]:	70
	Please note:	Clampshaft internal
8 320 19 008	Cut-off holder, height adjustable 845 IC	
	Weight [kg]:	1.500
	Notation:	180° reversible
	Shank type:	BMT
	Machine adaption:	Centering key b 20
	Tool adaption:	 System 845
	Coolant:	IC
	Pressure max [bar]:	70
	Please note:	Clampshaft internal



heimatec.u-tec®

heimatec.com

Products / Tool change systems /
u-tec® Tool-changing system



versions see catalog

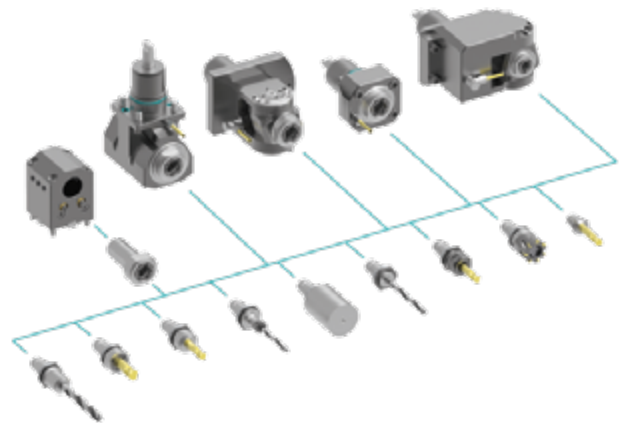

heimatec.easy-quick

heimatec.com

Products / Tool change systems /
easy-quick HT quick-changing system



versions see catalog

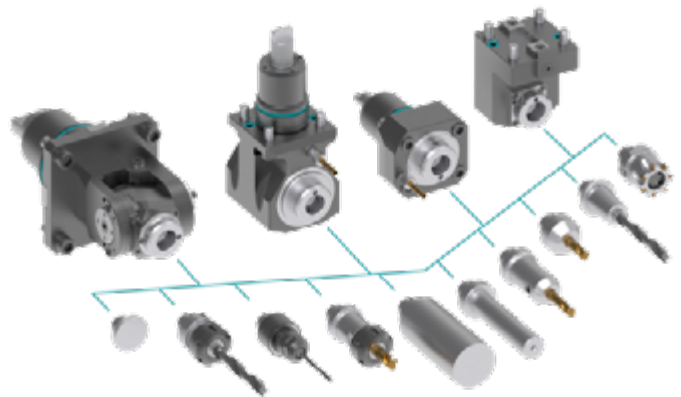

heimatec.Capto™

heimatec.com

Products / Tool change systems /
heimatec.Capto™ quick-changing system



versions see catalog

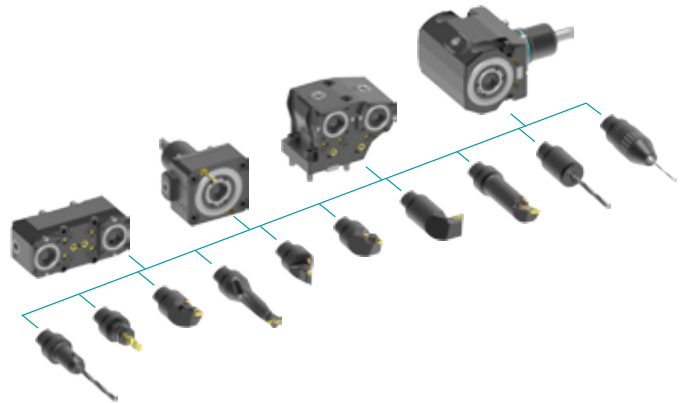

heimatec.accessories

heimatec.com

Products / Accessories



versions see catalog





● heimatec overseas branches

○ global representations of heimatec

heimatec[®]

heimatec GmbH
Präzisionswerkzeuge
Carl-Benz-Str. 4
77871 Renchen
Germany

T +49 7843 9466 0
www.heimatec.com
info@heimatec.com

Please find the contact details of our worldwide trading partners on our website:
<https://heimatec.com/business-partners>