

Doosan
Puma 5100
M/LY BMT 75



High-tech from heimatec - heimatec - Tools and systems for productive turning and milling

heimatec belongs to the international technology and quality leaders for precision tools and specializes in the development and production of high-precision static and live tools for all CNC lathes, CNC turn-/mill machines and CNC machining centers.

The range of products* spans from static BMT and VDI tool holders, live tools up to highly complex customer-specific individual solutions. heimatec, headquartered in Renchen, has a own subsidiary in Asia and India and numerous representatives as well as trading partners all over the world.

*OUR PRODCUTS

Static tool holders

Live tool units

Precision tools

Tools for turning and machining centres

Tools for swiss type lathes

Tool changing and uick-change systems

Tool systems for gear production

Digital tool management



This catalogue, including all its parts, is protected by copyright. Any use outside the restricted limitations of the Copyright Act without the consent of heimatec is inadmissible and liable to prosecution. This applies in particular to duplication, translation, microfilming and storage and processing in electronic systems.

heimatec GmbH reserves the right to make technical changes at any time without giving prior notice. This applies in particular to adjustments at any time to meet new or changed international standards, or in case of further developments of our products or manufacturing processes.

The current version of our General Terms and Conditions can be found on our website.

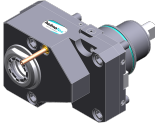

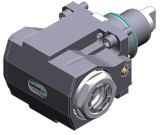
Part-#	Name	
8 010 67 039	Axial drilling and milling head ER 40 AX UT IC	
	Weight [kg]:	6.000
	Tool drive:	Flat (~DIN 1809)
	Shank size [mm]:	75.00
	Tool adaption:	ER 40 A - u-tec
	Gear ratio [i]:	1:1
	Torque max [Nm]:	100
	Rotation max [1/min]:	4000
	Rotating direction:	same
	Coolant:	IC/Ext
	Pressure max [bar]:	25
	Please note:	Combi bearing
8 010 67 049	Axial drilling and milling head C 5	
	Weight [kg]:	9.020
	Tool drive:	Flat (~DIN 1809)
	Shank size [mm]:	75.00
	Shank type:	BMT
	Tool adaption:	heimatec Capto(TM) C 5
	Gear ratio [i]:	1:1
	Torque max [Nm]:	100
	Rotation max [1/min]:	4000
	Rotating direction:	same
	Coolant:	EXT
8 010 67 059	Axial drilling and milling head ER 40 AX UT	
	Weight [kg]:	5.880
	Tool drive:	Flat (~DIN 1809)
	Shank size [mm]:	75.00
	Shank type:	BMT
	Tool adaption:	ER 40 A - u-tec
	Gear ratio [i]:	1:1
	Torque max [Nm]:	100
	Rotation max [1/min]:	4000
	Rotating direction:	same
	Coolant:	EXT
	Please note:	Combi bearing
8 010 67 099	Axial drilling and milling head ER 40 AX UT	
	Weight [kg]:	5.770
	Tool drive:	Flat (~DIN 1809)
	Shank size [mm]:	75.00
	Shank type:	BMT
	Tool adaption:	ER 40 A - u-tec
	Gear ratio [i]:	1:1
	Torque max [Nm]:	100
	Rotation max [1/min]:	6000
	Rotating direction:	same
	Coolant:	EXT
8 019 66 005	Axial drilling and milling head ER 32 AX UT	
	Weight [kg]:	9.440
	Notation:	offset; 180° reversible
	Tool drive:	Flat (~DIN 1809)
	Shank size [mm]:	75.00
	Shank type:	BMT
	Tool adaption:	ER 32 A - u-tec

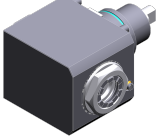
Part-#	Name	
		Gear ratio [i]: 1:2 Torque max [Nm]: 50 Rotation max [1/min]: 10000 Rotating direction: opposite Coolant: EXT Please note: stronger bearing Offset [mm]: 60
8 019 66 013	Axial drilling and milling head ER 32 AX UT	
		Weight [kg]: 9.550 Notation: offset; 180° reversible Tool drive: Flat (~DIN 1809) Shank size [mm]: 75.00 Shank type: BMT Tool adaption: ER 32 A - u-tec Gear ratio [i]: 1:1 Torque max [Nm]: 63 Rotation max [1/min]: 6000 Rotating direction: opposite Coolant: EXT Please note: stronger bearing Offset [mm]: 60
8 019 66 077	Axial drilling and milling head ER 32 AX UT IC	
		Notation: offset; 180° reversible Tool drive: Flat (~DIN 1809) Shank size [mm]: 75.00 Shank type: BMT Tool adaption: ER 32 A - u-tec Gear ratio [i]: 1:2 Torque max [Nm]: 50 Rotation max [1/min]: 10000 Rotating direction: opposite Coolant: IC/Ext Pressure max [bar]: 140 Please note: stronger bearing Offset [mm]: 60
8 030 65 086	Radial drilling and milling head ER 25 AX UT	
		Weight [kg]: 9.190 Notation: 180° reversible Tool drive: Flat (~DIN 1809) Shank size [mm]: 75.00 Shank type: BMT Tool adaption: ER 25 A - u-tec Gear ratio [i]: 1:2 Torque max [Nm]: 16 Rotation max [1/min]: 12000 Rotating direction: same Coolant: EXT Please note: stronger bearing Center distance [mm]: 100

Part-#	Name	
8 030 67 071	Radial drilling and milling head ER 40 AX UT IC	
	Weight [kg]:	14.160
	Notation:	180° reversible
	Tool drive:	Flat (~DIN 1809)
	Shank size [mm]:	75.00
	Shank type:	BMT
	Tool adaption:	ER 40 A - u-tec
	Gear ratio [i]:	1:1
	Torque max [Nm]:	100
	Rotation max [1/min]:	4000
	Rotating direction:	same
	Coolant:	IC/Ext
	Pressure max [bar]:	140
	Please note:	Combi bearing
	Center distance [mm]:	90
8 030 67 074	Radial drilling and milling head ER 40 AX UT	
	Weight [kg]:	13.920
	Notation:	180° reversible
	Tool drive:	Flat (~DIN 1809)
	Shank size [mm]:	75.00
	Shank type:	BMT
	Tool adaption:	ER 40 A - u-tec
	Gear ratio [i]:	1:1
	Torque max [Nm]:	100
	Rotation max [1/min]:	4000
	Rotating direction:	same
	Coolant:	EXT
	Please note:	Combi bearing
	Center distance [mm]:	90
8 030 67 105	Radial drilling and milling head ER 40 AX UT	
	Notation:	180° reversible
	Tool drive:	Flat (~DIN 1809)
	Shank size [mm]:	75.00
	Shank type:	BMT
	Tool adaption:	ER 40 A - u-tec
	Gear ratio [i]:	1:1
	Torque max [Nm]:	100
	Rotation max [1/min]:	6000
	Rotating direction:	same
	Coolant:	EXT
	Please note:	stronger bearing
	Center distance [mm]:	60
8 030 67 106	Radial drilling and milling head ER 40 AX UT IC	
	Weight [kg]:	14.040
	Notation:	180° reversible
	Tool drive:	Flat (~DIN 1809)
	Shank size [mm]:	75.00
	Shank type:	BMT
	Tool adaption:	ER 40 A - u-tec
	Gear ratio [i]:	1:1
	Torque max [Nm]:	100
	Rotation max [1/min]:	4000
	Rotating direction:	same
	Coolant:	IC/Ext

Part-#	Name	
	Pressure max [bar]:	140
	Please note:	stronger bearing
	Center distance [mm]:	60
8 030 68 048	Radial drilling and milling head HT 6 IC	
	Weight [kg]:	14.080
	Notation:	180° reversible
	Tool drive:	Flat (~DIN 1809)
	Shank size [mm]:	75.00
	Shank type:	BMT
	Tool adaption:	HT 6
	Gear ratio [i]:	1:1
	Torque max [Nm]:	100
	Rotation max [1/min]:	6000
	Rotating direction:	same
	Coolant:	IC/Ext
	Pressure max [bar]:	140
	Please note:	stronger bearing
	Center distance [mm]:	60
8 037 66 002	Radial disk mill head arbor 27	
	Weight [kg]:	16.610
	Version:	± 45° turnable; at 0° position can be pinned
	Tool drive:	Flat (~DIN 1809)
	Shank size [mm]:	75.00
	Shank type:	BMT
	Tool adaption:	Arbor 27
	Gear ratio [i]:	2:1
	Torque max [Nm]:	63
	Rotation max [1/min]:	3000
	Rotating direction:	same
	Coolant:	no
	Please note:	strong version; stronger bearing
	Center distance [mm]:	120
8 040 65 024	Universal head ± 90° adjustable ER 25 AX UT	
	Weight [kg]:	7.840
	Tool drive:	Flat (~DIN 1809)
	Shank size [mm]:	75.00
	Shank type:	BMT
	Tool adaption:	ER 25 u-tec
	Gear ratio [i]:	1:1
	Torque max [Nm]:	25
	Rotation max [1/min]:	6000
	Rotating direction:	opposite
	Coolant:	EXT
	Please note:	Note swivel range! ; stronger bearing
	Center distance [mm]:	90
8 202 20 014	Basic holder longitudinal seat FN 12	
	Weight [kg]:	2.700
	Notation:	180° reversible
	Shank type:	BMT
	Machine adaption:	Centering key b 25
	Tool adaption:	Interface FN 12
	Coolant:	EXT
	Center distance [mm]:	25

Part-#	Name	
8 224 26 002	Universal turning holder sq. 32/25	
	Shank type:	BMT
	Machine adaption:	Centering key b 25
	Tool adaption:	Sq. 32
	Coolant:	EXT
8 224 26 008	Universal turning holder sq. 1 1/4"/1"	
	Weight [kg]:	7.010
	Shank type:	BMT
	Machine adaption:	Centering key b 25
	Tool adaption:	Sq. 1 1/4" (31,75mm)
		1" (25,4mm)
	Coolant:	EXT
8 240 29 008	Boring bar holder Ø 60	
	Weight [kg]:	7.800
	Notation:	180° reversible
	Employment for:	Main- and sub spindle
	Shank type:	BMT
	Machine adaption:	Centering key slot b 25
	Tool adaption:	Ø 60
	Coolant:	IC/Ext
	Center distance [mm]:	60
8 240 29 020	Boring bar holder Ø 60	
	Weight [kg]:	14.520
	Notation:	180° reversible
	Shank type:	BMT
	Machine adaption:	Centering key b 25
	Tool adaption:	Ø 60
	Coolant:	IC/Ext
	Center distance [mm]:	110
8 240 29 026	Boring bar holder Ø 50	
	Weight [kg]:	15.380
	Notation:	180° reversible
	Employment for:	Main- and sub spindle
	Shank type:	BMT
	Machine adaption:	Centering key b 25
	Tool adaption:	Ø 50
	Coolant:	IC/Ext
	Center distance [mm]:	110
8 240 29 036	Boring bar holder Ø 2 1/2"	
	Weight [kg]:	14.080
	Notation:	180° reversible
	Shank type:	BMT
	Machine adaption:	Centering key b 25
	Tool adaption:	Ø 2 1/2" (63,5mm)
	Coolant:	IC/Ext
	Center distance [mm]:	110

Part-#	Name	
8 240 29 051	Boring bar holder Ø 2"	
	Weight [kg]:	15.460
	Notation:	180° reversible
	Shank type:	BMT
	Machine adaption:	Centering key b 25
	Tool adaption:	Ø 2" (50,8mm)
	Coolant:	IC/Ext
	Center distance [mm]:	110
8 244 25 002	Combi facing holder sq. 25	
	Weight [kg]:	4.100
	Shank type:	BMT
	Machine adaption:	Centering key slot b 25
	Tool adaption:	Sq. 25
		Sq. 25
	Coolant:	EXT
8 244 26 002	Combi facing holder sq. 32/25	
	Weight [kg]:	14.750
	Notation:	180° reversible
	Shank type:	BMT
	Machine adaption:	Centering key b 25
	Tool adaption:	Sq. 32/25
	Coolant:	EXT
	Please note:	with spacer strip for sq. 25
	Center distance [mm]:	105
8 244 26 005	Combi facing holder sq. 1 1/4"/1"	
	Weight [kg]:	14.780
	Notation:	180° reversible
	Shank type:	BMT
	Machine adaption:	Centering key b 25
	Tool adaption:	Sq. 1 1/4" (31,75mm) / sq. 1" (25,4mm)
	Coolant:	EXT
	Please note:	with spacer strip for sq. 1" (25,4mm)
	Center distance [mm]:	105
8 320 23 011	Cut-off holder, height adjustable SH 32 IC	
	Weight [kg]:	3.290
	Notation:	180° reversible
	Shank type:	BMT
	Machine adaption:	Centering key b 25
	Tool adaption:	Clampshaft SH 32
	Coolant:	IC/Ext
	Pressure max [bar]:	70
8 320 23 025	Cut-off holder, height adjustable SH 32 IC	
	Weight [kg]:	3.460
	Notation:	180° reversible
	Shank type:	BMT
	Machine adaption:	Centering key b 25
	Tool adaption:	Clampshaft SH 32
	Coolant:	IC/Ext
	Pressure max [bar]:	70
	Please note:	Clampshaft internal



heimatec.u-tec®

heimatec.com

Products / Tool change systems /
u-tec® Tool-changing system



versions see catalog

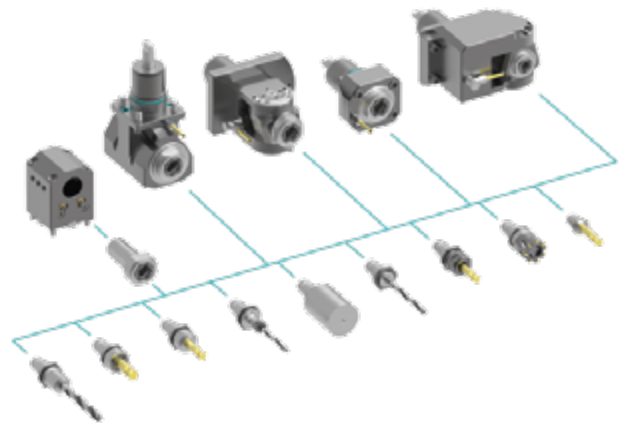

heimatec.easy-quick

heimatec.com

Products / Tool change systems /
easy-quick HT quick-changing system



versions see catalog

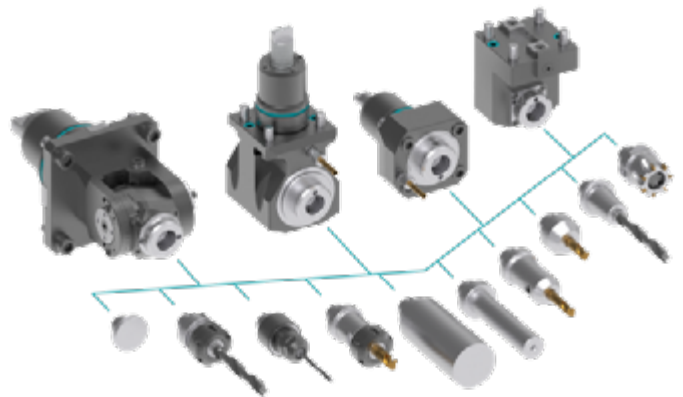

heimatec.Capto™

heimatec.com

Products / Tool change systems /
heimatec.Capto™ quick-changing system



versions see catalog

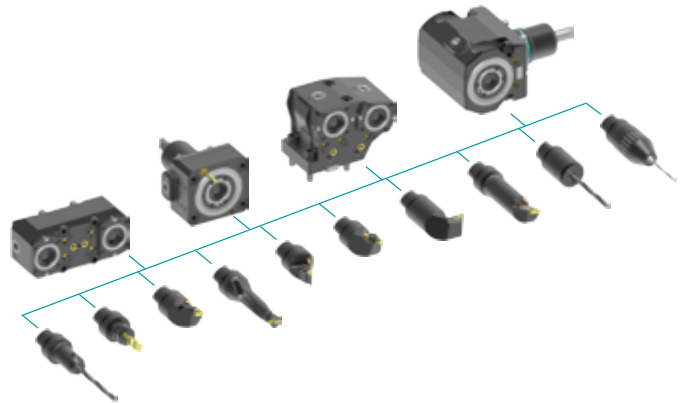

heimatec.accessories

heimatec.com

Products / Accessories



versions see catalog





● heimatec overseas branches

○ global representations of heimatec

heimatec[®]

heimatec GmbH
Präzisionswerkzeuge
Carl-Benz-Str. 4
77871 Renchen
Germany

T +49 7843 9466 0
www.heimatec.com
info@heimatec.com

Please find the contact details of our worldwide trading partners on our website:
<https://heimatec.com/business-partners>