

Victor  
**Q 200 T3Y3 -  
BMT 55**



# High-tech from heimatec - heimatec - Tools and systems for productive turning and milling

heimatec belongs to the international technology and quality leaders for precision tools and specializes in the development and production of high-precision static and live tools for all CNC lathes, CNC turn-/mill machines and CNC machining centers.

The range of products\* spans from static BMT and VDI tool holders, live tools up to highly complex customer-specific individual solutions. heimatec, headquartered in Renchen, has a own subsidiary in Asia and India and numerous representatives as well as trading partners all over the world.

## \*OUR PRODCUTS

Static tool holders

Live tool units

Precision tools

Tools for turning and machining centres

Tools for swiss type lathes

Tool changing and uick-change systems



Tool systems for gear production

Digital tool management

This catalogue, including all its parts, is protected by copyright. Any use outside the restricted limitations of the Copyright Act without the consent of heimatec is inadmissible and liable to prosecution. This applies in particular to duplication, translation, microfilming and storage and processing in electronic systems.



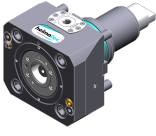

**heimatec GmbH** reserves the right to make technical changes at any time without giving prior notice. This applies in particular to adjustments at any time to meet new or changed international standards, or in case of further developments of our products or manufacturing processes.



The current version of our General Terms and Conditions can be found on our website.



Part-#	Name	
<b>8 010 55 038</b>	<b>Axial drilling and milling head ER 25 AX UT IC</b>	
	Weight [kg]:	3.050
	Tool drive:	Flat (~DIN 1809)
	Shank size [mm]:	55.00
	Shank type:	BMT
	Tool adaption:	ER 25 A - u-tec
	Gear ratio [i]:	1:1
	Torque max [Nm]:	50
	Rotation max [1/min]:	6000
	Rotating direction:	same
	Coolant:	IC/Ext
	Pressure max [bar]:	25
	Please note:	Combi bearing
<b>8 010 55 039</b>	<b>Axial drilling and milling head ER 25 AX UT</b>	
	Notation:	180° reversible
	Tool drive:	Flat (~DIN 1809)
	Shank size [mm]:	55.00
	Shank type:	BMT
	Tool adaption:	ER 25 A - u-tec
	Gear ratio [i]:	1:1
	Torque max [Nm]:	50
	Rotation max [1/min]:	12000
	Rotating direction:	same
	Coolant:	EXT
	Pressure max [bar]:	140
<b>8 010 55 051</b>	<b>Axial drilling and milling head Weldon 3/4"</b>	
	Weight [kg]:	3.390
	Tool drive:	Flat (~DIN 1809)
	Shank size [mm]:	55.00
	Shank type:	BMT
	Tool adaption:	Weldon (DIN 1835 b) 3/4" (19,05mm)
	Gear ratio [i]:	1:1
	Torque max [Nm]:	50
	Rotation max [1/min]:	6000
	Rotating direction:	same
	Coolant:	EXT
	Please note:	Combi bearing
<b>8 010 55 080</b>	<b>Axial drilling and milling head C 3</b>	
	Weight [kg]:	4.240
	Notation:	180° reversible
	Tool drive:	Flat (~DIN 1809)
	Shank size [mm]:	55.00
	Shank type:	BMT
	Tool adaption:	heimatec Capto(TM) C 3
	Gear ratio [i]:	1:1
	Torque max [Nm]:	50
	Rotation max [1/min]:	6000
	Rotating direction:	same
	Coolant:	EXT
	Please note:	Check applicability; tool length check !

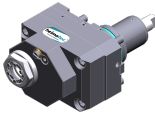

Part-#	Name	
<b>8 010 55 120</b>	<b>Axial drilling and milling head ER 25 AX UT</b>	
	Weight [kg]:	3.190
	Tool drive:	Flat (~DIN 1809)
	Shank size [mm]:	55.00
	Shank type:	BMT
	Tool adaption:	ER 25 A - u-tec
	Gear ratio [i]:	1:1
	Torque max [Nm]:	50
	Rotation max [1/min]:	8000
	Rotating direction:	same
	Coolant:	EXT
<b>8 010 56 035</b>	<b>Axial drilling and milling head HT 4 IC</b>	
	Tool drive:	Flat (~DIN 1809)
	Shank size [mm]:	55.00
	Shank type:	BMT
	Tool adaption:	HT 4
	Gear ratio [i]:	1:1
	Torque max [Nm]:	50
	Rotation max [1/min]:	6000
	Rotating direction:	same
	Coolant:	IC/Ext
	Pressure max [bar]:	25
	Please note:	stronger bearing
<b>8 010 56 039</b>	<b>Axial drilling and milling head ER 32 AX UT</b>	
	Weight [kg]:	3.200
	Tool drive:	Flat (~DIN 1809)
	Shank size [mm]:	55.00
	Shank type:	BMT
	Tool adaption:	ER 32 A - u-tec
	Gear ratio [i]:	1:1
	Torque max [Nm]:	50
	Rotation max [1/min]:	6000
	Rotating direction:	same
	Coolant:	EXT
	Please note:	Combi bearing
<b>8 010 56 040</b>	<b>Axial drilling and milling head ER 32 AX UT IC</b>	
	Weight [kg]:	3.220
	Tool drive:	Flat (~DIN 1809)
	Shank size [mm]:	55.00
	Shank type:	BMT
	Tool adaption:	ER 32 A - u-tec
	Gear ratio [i]:	1:1
	Torque max [Nm]:	50
	Rotation max [1/min]:	6000
	Rotating direction:	same
	Coolant:	IC/Ext
	Pressure max [bar]:	25
	Please note:	Combi bearing



Part-#	Name	
<b>8 010 56 047</b>	<b>Axial drilling and milling head HT 4 IC</b>	
	Tool drive:	Flat (~DIN 1809)
	Shank size [mm]:	55.00
	Shank type:	BMT
	Tool adaption:	HT 4
	Gear ratio [i]:	1:1
	Torque max [Nm]:	50
	Rotation max [1/min]:	6000
	Rotating direction:	same
	Coolant:	IC/Ext
	Pressure max [bar]:	25
	Please note:	Combi bearing
<b>8 010 56 119</b>	<b>Axial drilling and milling head C 4 IC</b>	
	Notation:	180° reversible
	Tool drive:	Flat (~DIN 1809)
	Shank size [mm]:	55.00
	Shank type:	BMT
	Tool adaption:	heimatec Capto(TM) C 4
	Gear ratio [i]:	1:1
	Torque max [Nm]:	50
	Rotation max [1/min]:	6000
	Rotating direction:	same
	Coolant:	IC/Ext
	Pressure max [bar]:	100
	Please note:	Check applicability; tool length check !;
<b>8 013 54 008</b>	<b>Axial drilling and milling head ER 16 AX UT</b>	
	Weight [kg]:	2.480
	Tool drive:	Flat (~DIN 1809)
	Shank size [mm]:	55.00
	Shank type:	BMT
	Tool adaption:	ER 16 A - u-tec
	Gear ratio [i]:	1:4
	Torque max [Nm]:	5
	Rotation max [1/min]:	24000
	Rotating direction:	same
	Coolant:	EXT
<b>8 013 54 009</b>	<b>Axial drilling and milling head ER 16 AX UT IC</b>	
	Tool drive:	Flat (~DIN 1809)
	Shank size [mm]:	55.00
	Shank type:	BMT
	Tool adaption:	ER 16 A - u-tec
	Gear ratio [i]:	1:4
	Torque max [Nm]:	5
	Rotation max [1/min]:	24000
	Rotating direction:	same
	Coolant:	IC/Ext
	Pressure max [bar]:	100

Part-#	Name	
<b>8 019 55 050</b>	<b>Axial drilling and milling head ER 25 AX UT</b>	
	Weight [kg]:	5.000
	Notation:	offset; 180° reversible
	Tool drive:	Flat (~DIN 1809)
	Shank size [mm]:	55.00
	Shank type:	BMT
	Tool adaption:	ER 25 A - u-tec
	Gear ratio [i]:	1:1
	Torque max [Nm]:	40
	Rotation max [1/min]:	8000
	Rotating direction:	opposite
	Coolant:	EXT
	Please note:	stronger bearing
	Offset [mm]:	42
<b>8 019 55 051</b>	<b>Axial drilling and milling head ER 25 AX UT</b>	
	Weight [kg]:	5.010
	Notation:	offset; 180° reversible
	Tool drive:	Flat (~DIN 1809)
	Shank size [mm]:	55.00
	Shank type:	BMT
	Tool adaption:	ER 25 A - u-tec
	Gear ratio [i]:	2:1
	Torque max [Nm]:	50
	Rotation max [1/min]:	3000
	Rotating direction:	opposite
	Coolant:	EXT
	Please note:	stronger bearing
	Offset [mm]:	42
<b>8 019 55 052</b>	<b>Axial drilling and milling head ER 25 AX UT</b>	
	Weight [kg]:	5.020
	Notation:	offset; 180° reversible
	Tool drive:	Flat (~DIN 1809)
	Shank size [mm]:	55.00
	Shank type:	BMT
	Tool adaption:	ER 25 A - u-tec
	Gear ratio [i]:	1:3
	Torque max [Nm]:	16
	Rotation max [1/min]:	18000
	Rotating direction:	opposite
	Coolant:	EXT
	Please note:	stronger bearing
	Offset [mm]:	42
<b>8 019 55 053</b>	<b>Axial drilling and milling head ER 25 AX UT</b>	
	Weight [kg]:	4.980
	Notation:	offset; 180° reversible
	Tool drive:	Flat (~DIN 1809)
	Shank size [mm]:	55.00
	Shank type:	BMT
	Tool adaption:	ER 25 A - u-tec
	Gear ratio [i]:	1:2
	Torque max [Nm]:	25
	Rotation max [1/min]:	16000
	Rotating direction:	opposite

Part-#	Name	
	Coolant:	EXT
	Please note:	stronger bearing
	Offset [mm]:	42
<b>8 019 55 054</b>	<b>Axial drilling and milling head ER 25 AX UT IC</b>	
	Notation:	offset; 180° reversible
	Tool drive:	Flat (~DIN 1809)
	Shank size [mm]:	55.00
	Shank type:	BMT
	Tool adaption:	ER 25 A - u-tec
	Gear ratio [i]:	1:1
	Torque max [Nm]:	40
	Rotation max [1/min]:	6000
	Rotating direction:	opposite
	Coolant:	IC/Ext
	Pressure max [bar]:	140
	Please note:	stronger bearing
	Offset [mm]:	42
<b>8 019 55 056</b>	<b>Axial drilling and milling head ER 25 AX UT IC</b>	
	Weight [kg]:	6.130
	Notation:	offset; 180° reversible
	Tool drive:	Flat (~DIN 1809)
	Shank size [mm]:	55.00
	Shank type:	BMT
	Tool adaption:	ER 25 A - u-tec
	Gear ratio [i]:	1:3
	Torque max [Nm]:	16
	Rotation max [1/min]:	18000
	Rotating direction:	opposite
	Coolant:	IC/Ext
	Pressure max [bar]:	140
	Please note:	stronger bearing
	Offset [mm]:	42
<b>8 019 55 057</b>	<b>Axial drilling and milling head ER 25 AX UT IC</b>	
	Weight [kg]:	6.060
	Notation:	offset; 180° reversible
	Tool drive:	Flat (~DIN 1809)
	Shank size [mm]:	55.00
	Shank type:	BMT
	Tool adaption:	ER 25 A - u-tec
	Gear ratio [i]:	1:2
	Torque max [Nm]:	25
	Rotation max [1/min]:	16000
	Rotating direction:	opposite
	Coolant:	IC/Ext
	Pressure max [bar]:	140
	Please note:	stronger bearing
	Offset [mm]:	42

Part-#	Name	
<b>8 030 54 053</b>	<b>Radial drilling and milling head ER 16 AX UT IC</b>	
	Weight [kg]:	7.290
	Notation:	180° reversible
	Tool drive:	Flat (~DIN 1809)
	Shank size [mm]:	55.00
	Shank type:	BMT
	Tool adaption:	ER 16 A - u-tec
	Gear ratio [i]:	1:4
	Torque max [Nm]:	5
	Rotation max [1/min]:	24000
	Rotating direction:	opposite
	Coolant:	IC/Ext
	Pressure max [bar]:	140
	Center distance [mm]:	70
<b>8 030 55 058</b>	<b>Radial drilling and milling head C 3</b>	
	Weight [kg]:	7.560
	Notation:	180° reversible
	Tool drive:	Flat (~DIN 1809)
	Shank size [mm]:	55.00
	Shank type:	BMT
	Tool adaption:	heimatec Capto(TM) C 3
	Gear ratio [i]:	1:1
	Torque max [Nm]:	25
	Rotation max [1/min]:	8000
	Rotating direction:	opposite
	Coolant:	EXT
	Please note:	Check applicability; note tool length!
	Center distance [mm]:	70
<b>8 030 55 067</b>	<b>Radial drilling and milling head ER 25 AX UT IC</b>	
	Notation:	180° reversible
	Tool drive:	Flat (~DIN 1809)
	Shank size [mm]:	55.00
	Shank type:	BMT
	Tool adaption:	ER 25 A - u-tec
	Gear ratio [i]:	1:3
	Torque max [Nm]:	12
	Rotation max [1/min]:	18000
	Rotating direction:	same
	Coolant:	IC/Ext
	Pressure max [bar]:	140
	Please note:	stronger bearing
	Center distance [mm]:	80
<b>8 030 55 102</b>	<b>Radial drilling and milling head ER 25 AX UT</b>	
	Weight [kg]:	6.900
	Notation:	180° reversible
	Tool drive:	Flat (~DIN 1809)
	Shank size [mm]:	55.00
	Shank type:	BMT
	Tool adaption:	ER 25 A - u-tec
	Gear ratio [i]:	1:1
	Torque max [Nm]:	50
	Rotation max [1/min]:	12000
	Rotating direction:	same
	Coolant:	EXT

Part-#	Name	
	Center distance [mm]:	70
<b>8 030 55 120</b>	<b>Radial drilling and milling head ER 25 AX UT IC</b>	
	Tool drive:	Flat (~DIN 1809)
	Shank size [mm]:	55.00
	Tool adaption:	ER 25 A - u-tec
	Gear ratio [i]:	1:1
	Torque max [Nm]:	50
	Rotation max [1/min]:	12000
	Rotating direction:	same
	Coolant:	IC/Ext
	Pressure max [bar]:	140
	Center distance [mm]:	70
<b>8 030 55 175</b>	<b>Radial drilling and milling head ER 25 AX UT</b>	
	Notation:	180° reversible
	Tool drive:	Flat (~DIN 1809)
	Shank size [mm]:	55.00
	Shank type:	BMT
	Tool adaption:	ER 25 A - u-tec
	Gear ratio [i]:	1:1
	Torque max [Nm]:	50
	Rotation max [1/min]:	12000
	Rotating direction:	same
	Coolant:	EXT
	Please note:	stronger bearing
	Center distance [mm]:	60
<b>8 030 55 176</b>	<b>Radial drilling and milling head ER 25 AX UT IC</b>	
	Weight [kg]:	6.500
	Notation:	180° reversible
	Tool drive:	Flat (~DIN 1809)
	Shank size [mm]:	55.00
	Shank type:	BMT
	Tool adaption:	ER 25 A - u-tec
	Gear ratio [i]:	1:1
	Torque max [Nm]:	50
	Rotation max [1/min]:	12000
	Rotating direction:	same
	Coolant:	IC/Ext
	Pressure max [bar]:	140
	Please note:	stronger bearing
	Center distance [mm]:	60
<b>8 030 56 052</b>	<b>Radial drilling and milling head ER 32 AX UT</b>	
	Tool drive:	Flat (~DIN 1809)
	Shank size [mm]:	55.00
	Shank type:	BMT
	Tool adaption:	ER 32 A - u-tec
	Gear ratio [i]:	1:1
	Torque max [Nm]:	50
	Rotation max [1/min]:	6000
	Rotating direction:	same
	Coolant:	EXT
	Please note:	stronger bearing
	Center distance [mm]:	70

Part-#	Name
<b>8 030 56 056</b>	<b>Radial drilling and milling head ER 32 AX UT IC</b>
	Weight [kg]: 7.150 Notation: 180° reversible Tool drive: Flat (~DIN 1809) Shank size [mm]: 55.00 Shank type: BMT Tool adaption: ER 32 A - u-tec Gear ratio [i]: 1:1 Torque max [Nm]: 50 Rotation max [1/min]: 12000 Rotating direction: same Coolant: IC/Ext Pressure max [bar]: 140 Center distance [mm]: 70
<b>8 030 56 172</b>	<b>Radial drilling and milling head ER 32 AX UT IC</b>
	Weight [kg]: 6.830 Notation: 180° reversible Tool drive: Flat (~DIN 1809) Shank size [mm]: 55.00 Shank type: BMT Tool adaption: ER 32 A - u-tec Gear ratio [i]: 2:1 Torque max [Nm]: 63 Rotation max [1/min]: 3000 Rotating direction: opposite Coolant: IC/Ext Pressure max [bar]: 140 Please note: Combi bearing Center distance [mm]: 70
<b>8 030 56 274</b>	<b>Radial drilling and milling head ER 32 AX UT</b>
	Weight [kg]: 6.720 Notation: 180° reversible Tool drive: Flat (~DIN 1809) Shank size [mm]: 55.00 Shank type: BMT Tool adaption: ER 32 A - u-tec Gear ratio [i]: 1:1 Torque max [Nm]: 50 Rotation max [1/min]: 12000 Rotating direction: same Coolant: EXT Center distance [mm]: 70
<b>8 039 55 036</b>	<b>Radial drilling and milling head ER 25 AX UT</b>
	Weight [kg]: 7.110 Notation: 180° reversible Employment for: Main- and sub spindle Version: double spindle Tool drive: Flat (~DIN 1809) Shank size [mm]: 55.00 Shank type: BMT Tool adaption: ER 25 A - u-tec Gear ratio [i]: 1:1 Torque max [Nm]: 50 Rotation max [1/min]: 6000

Part-#	Name	
	Rotating direction:	same/opposite
	Coolant:	EXT
	Please note:	stronger bearing
	Center distance [mm]:	70
<b>8 039 55 051</b>	<b>Radial drilling and milling head ER 25 AX UT</b>	
	Weight [kg]:	7.000
	Version:	double spindle
	Tool drive:	Flat (~DIN 1809)
	Shank size [mm]:	55.00
	Shank type:	BMT
	Tool adaption:	ER 25 A - u-tec
	Gear ratio [i]:	1:1
	Torque max [Nm]:	50
	Rotation max [1/min]:	12000
	Rotating direction:	same/opposite
	Coolant:	EXT
	Center distance [mm]:	60
<b>8 039 56 022</b>	<b>Radial drilling and milling head ER 32 AX UT</b>	
	Weight [kg]:	7.000
	Notation:	180° reversible
	Employment for:	Main- and sub spindle
	Version:	double spindle
	Tool drive:	Flat (~DIN 1809)
	Shank size [mm]:	55.00
	Shank type:	BMT
	Tool adaption:	ER 32 A - u-tec
	Gear ratio [i]:	1:1
	Torque max [Nm]:	50
	Rotation max [1/min]:	6000
	Rotating direction:	same/opposite
	Coolant:	EXT
	Please note:	stronger bearing
	Center distance [mm]:	70
<b>8 039 56 035</b>	<b>Radial drilling and milling head ER 32 AX UT</b>	
	Weight [kg]:	6.970
	Notation:	180° reversible
	Employment for:	Main- and sub spindle
	Version:	double spindle, special
	Tool drive:	Flat (~DIN 1809)
	Shank size [mm]:	55.00
	Shank type:	BMT
	Tool adaption:	ER 32 A - u-tec
	Gear ratio [i]:	1:1
	Torque max [Nm]:	50
	Rotation max [1/min]:	6000
	Rotating direction:	same/opposite
	Coolant:	no
	Please note:	Operation only with air purge, no coolant
	Center distance [mm]:	70

Part-#	Name	
<b>8 043 54 006</b>	<b>Universal head +110°/-20° adj. ER16 AX UT</b>	
	Weight [kg]:	5.940
	Notation:	offset; 180° reversible
	Tool drive:	Flat (~DIN 1809)
	Shank size [mm]:	55.00
	Shank type:	BMT
	Tool adaption:	ER 16 A - u-tec
	Gear ratio [i]:	1:1
	Torque max [Nm]:	25
	Rotation max [1/min]:	6000
	Rotating direction:	opposite
	Coolant:	EXT
	Center distance [mm]:	50
	Offset [mm]:	35
<b>8 043 54 013</b>	<b>Universal head +110°/-20° adj. ER16 AX UT</b>	
	Weight [kg]:	6.320
	Notation:	offset; 180° reversible
	Tool drive:	Flat (~DIN 1809)
	Shank size [mm]:	55.00
	Shank type:	BMT
	Tool adaption:	ER 16 A - u-tec
	Gear ratio [i]:	1:2
	Torque max [Nm]:	12
	Rotation max [1/min]:	12000
	Rotating direction:	opposite
	Coolant:	EXT
	Center distance [mm]:	50
	Offset [mm]:	35
<b>8 043 55 005</b>	<b>Universal head +110°/-20° adj. ER25 AX UT</b>	
	Weight [kg]:	6.170
	Notation:	offset, 180° reversible
	Tool drive:	Flat (~DIN 1809)
	Shank size [mm]:	55.00
	Shank type:	BMT
	Tool adaption:	ER 25 A - u-tec
	Gear ratio [i]:	1:1
	Torque max [Nm]:	25
	Rotation max [1/min]:	6000
	Rotating direction:	opposite
	Coolant:	EXT
	Please note:	stronger bearing
	Center distance [mm]:	50
	Offset [mm]:	35
<b>8 043 55 009</b>	<b>Universal head +110°/-20° adj. ER25AX UTIK</b>	
	Weight [kg]:	6.320
	Notation:	offset, 180° reversible
	Tool drive:	Flat (~DIN 1809)
	Shank size [mm]:	55.00
	Shank type:	BMT
	Tool adaption:	ER 25 A - u-tec
	Gear ratio [i]:	1:1
	Torque max [Nm]:	25
	Rotation max [1/min]:	6000

Victor

## Q 200 T3Y3 - BMT 55

heimatec®

Part-#

Name

Rotating direction: opposite  
Coolant: IC/Ext  
Pressure max [bar]: 25  
Please note: stronger bearing  
Center distance [mm]: 50  
Offset [mm]: 35

8 043 55 027

**Universal head +110°/-20° adj. ER25 AX UT**

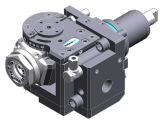

Weight [kg]: 6.180  
Notation: offset, 180° reversible  
Version: at 45° position can be pinned  
Tool drive: Flat (~DIN 1809)  
Shank size [mm]: 55.00  
Shank type: BMT  
Tool adaption: ER 25 A - u-tec  
Gear ratio [i]: 1:1  
Torque max [Nm]: 25  
Rotation max [1/min]: 6000  
Rotating direction: opposite  
Coolant: EXT  
Please note: stronger bearing  
Center distance [mm]: 50  
Offset [mm]: 35

8 053 54 030

**Multispindle radial head ER 16 AXUT IC**

Weight [kg]: 6.880  
Notation: 180° reversible  
Version: 2-spindles  
Tool drive: Flat (~DIN 1809)  
Shank size [mm]: 55.00  
Shank type: BMT  
Tool adaption: ER 16 A - u-tec  
Gear ratio [i]: 1:2  
Torque max [Nm]: 8  
Rotation max [1/min]: 12000  
Rotating direction: same  
Coolant: IC/Ext  
Pressure max [bar]: 25  
Center distance [mm]: 70

8 200 02 003

**Cover plate**

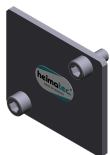

Weight [kg]: 0.361  
Shank size [mm]: 55.00  
Shank type: BMT

8 224 03 003

**Cut-off holder SH 32**

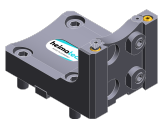

Weight [kg]: 1.810  
Notation: 180° reversible  
Employment for: Cut-off tool 32  
Version: Clampshaft on turret side  
Shank type: BMT  
Machine adaption: Centering key b 15  
Tool adaption: Clampshaft SH 32  
Coolant: EXT



Part-#	Name	
<b>8 224 04 002</b>	<b>Universal turning holder sq. 20</b>	
	Weight [kg]:	3.460
	Shank type:	BMT
	Machine adaption:	Centering key b 15
	Tool adaption:	Sq. 20
	Coolant:	EXT
<b>8 224 04 062</b>	<b>Universal turning holder sq. 20 IC</b>	
	Weight [kg]:	3.020
	Shank type:	BMT
	Machine adaption:	Centering key b 15
	Tool adaption:	Sq. 20
		Sq. 20
	Coolant:	IC/Ext
	Pressure max [bar]:	100
	Please note:	Key rail
<b>8 224 05 003</b>	<b>Universal turning holder sq. 25</b>	
	Weight [kg]:	3.620
	Notation:	180° reversible
	Shank type:	BMT
	Machine adaption:	Centering key b 15
	Tool adaption:	Sq. 25
	Coolant:	EXT
<b>8 224 05 005</b>	<b>Universal turning holder sq. 1"</b>	
	Weight [kg]:	3.560
	Shank type:	BMT
	Machine adaption:	Centering key b 15
	Tool adaption:	Sq. 1" (25,4mm)
	Coolant:	EXT
<b>8 224 05 015</b>	<b>Universal turning holder sq. 25/20</b>	
	Weight [kg]:	3.780
	Notation:	180° reversible
	Shank type:	BMT
	Machine adaption:	Centering key b 15
	Tool adaption:	Sq. 25/20
	Coolant:	EXT
	Pressure max [bar]:	80
	Please note:	with spacer strip for sq. 20
<b>8 224 05 023</b>	<b>Universal turning holder sq. 25/20</b>	
	Weight [kg]:	3.150
	Notation:	180° reversible
	Shank type:	BMT
	Machine adaption:	Centering key b 15
	Tool adaption:	Sq. 25/20
	Coolant:	EXT
	Please note:	with spacer strip for sq. 20

Part-#	Name	
8 240 07 069	<b>Boring bar holder Ø 25</b>	
	Notation:	180° reversible
	Employment for:	Main- and sub spindle
	Shank type:	BMT
	Machine adaption:	Centering key b 15
	Tool adaption:	Ø 25
	Coolant:	IC/Ext
	Center distance [mm]:	70
8 240 08 009	<b>Boring bar holder Ø 1 1/2"</b>	
	Weight [kg]:	5.470
	Notation:	180° reversible
	Employment for:	Main- and sub spindle
	Shank type:	BMT
	Machine adaption:	Centering key b 15
	Tool adaption:	Ø 1 1/2" (38,1mm)
	Coolant:	IC/Ext
	Center distance [mm]:	70
8 240 09 009	<b>Boring bar holder Ø 40</b>	
	Weight [kg]:	5.640
	Notation:	180° reversible
	Employment for:	Main- and sub spindle
	Shank type:	BMT
	Machine adaption:	Centering key b 15
	Tool adaption:	Ø 40
	Coolant:	IC/Ext
	Pressure max [bar]:	80
	Center distance [mm]:	70
8 244 05 003	<b>Combi facing holder sq. 25</b>	
	Weight [kg]:	5.340
	Notation:	180° reversible
	Employment for:	Main- and sub spindle
	Shank type:	BMT
	Machine adaption:	Centering key b 15
	Tool adaption:	Sq. 25
	Coolant:	EXT
	Pressure max [bar]:	80
8 244 05 006	<b>Combi facing holder sq. 1"</b>	
	Weight [kg]:	5.310
	Notation:	180° reversible
	Employment for:	Main- and sub spindle
	Shank type:	BMT
	Machine adaption:	Centering key b 15
	Tool adaption:	Sq. 1" (25,4mm)
	Coolant:	EXT
8 251 05 001	<b>Combi double turning holder sq. 25</b>	
	Weight [kg]:	7.700
	Employment for:	Main- and sub spindle
	Shank type:	BMT
	Machine adaption:	Centering key b 15
	Tool adaption:	Sq. 25
		Sq. 25

Part-#

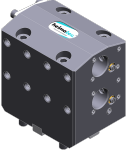
Name

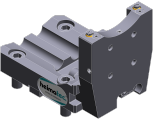
		Sq. 25 Sq. 25 EXT 80
	Coolant: Pressure max [bar]:	
<b>8 253 07 011</b>	<b>Double boring bar holder Ø 25</b>	
	Weight [kg]: Notation: Employment for: Shank type: Machine adaption: Tool adaption:	6.770 180° reversible Main- and sub spindle BMT Centering key b 15 Ø 25 Ø 25
	Coolant: Pressure max [bar]: Please note: Center distance [mm]:	IC/Ext 80 Check applicability; note tool length 52/97
<b>8 253 07 031</b>	<b>Double boring bar holder Ø 1"</b>	
	Weight [kg]: Notation: Employment for: Shank type: Machine adaption: Tool adaption:	7.620 180° reversible Main- and sub spindle BMT Centering key b 15 Ø 1" (25,4mm) Ø 1" (25,4mm)
	Coolant: Center distance [mm]:	IC/Ext 52/97
<b>8 253 07 047</b>	<b>Double boring bar holder Ø 25</b>	
	Weight [kg]: Notation: Employment for: Shank type: Machine adaption: Tool adaption:	6.940 180° reversible Main- and sub spindle BMT Centering key b 15 Ø 25 Ø 25
	Coolant: Center distance [mm]:	IC/Ext 44/87
<b>8 253 08 002</b>	<b>Double boring bar holder Ø 32</b>	
	Weight [kg]: Notation: Employment for: Shank type: Machine adaption: Tool adaption:	6.340 180° reversible Main- and sub spindle BMT Centering key b 15 Ø 32 Ø 32
	Coolant: Center distance [mm]:	IC/Ext 44/87

Part-#	Name	
<b>8 259 04 007</b>	<b>Multiple turning holder sq. 20</b>	
	Weight [kg]:	8.180
	Notation:	180° reversible
	Employment for:	Main- and sub spindle
	Version:	Special
	Shank type:	BMT
	Machine adaption:	Centering key b 15
	Tool adaption:	Sq. 20
		Sq. 20
		Sq. 20
	Coolant:	IC/Ext
<b>8 320 03 025</b>	<b>Cut-off holder, height adjustable SH 32 IC</b>	
	Weight [kg]:	1.910
	Notation:	180° reversible
	Shank type:	BMT
	Machine adaption:	Centering key b 15
	Tool adaption:	Clampshaft SH 32
	Coolant:	IC/Ext
	Pressure max [bar]:	70
	Please note:	Clampshaft internal
<b>8 320 09 001</b>	<b>Cut-off holder, height adjustable 845 IC</b>	
	Weight [kg]:	1.730
	Notation:	180° reversible
	Shank type:	BMT
	Machine adaption:	Centering key b 15
	Tool adaption:	 System 845
	Coolant:	IC
	Pressure max [bar]:	70

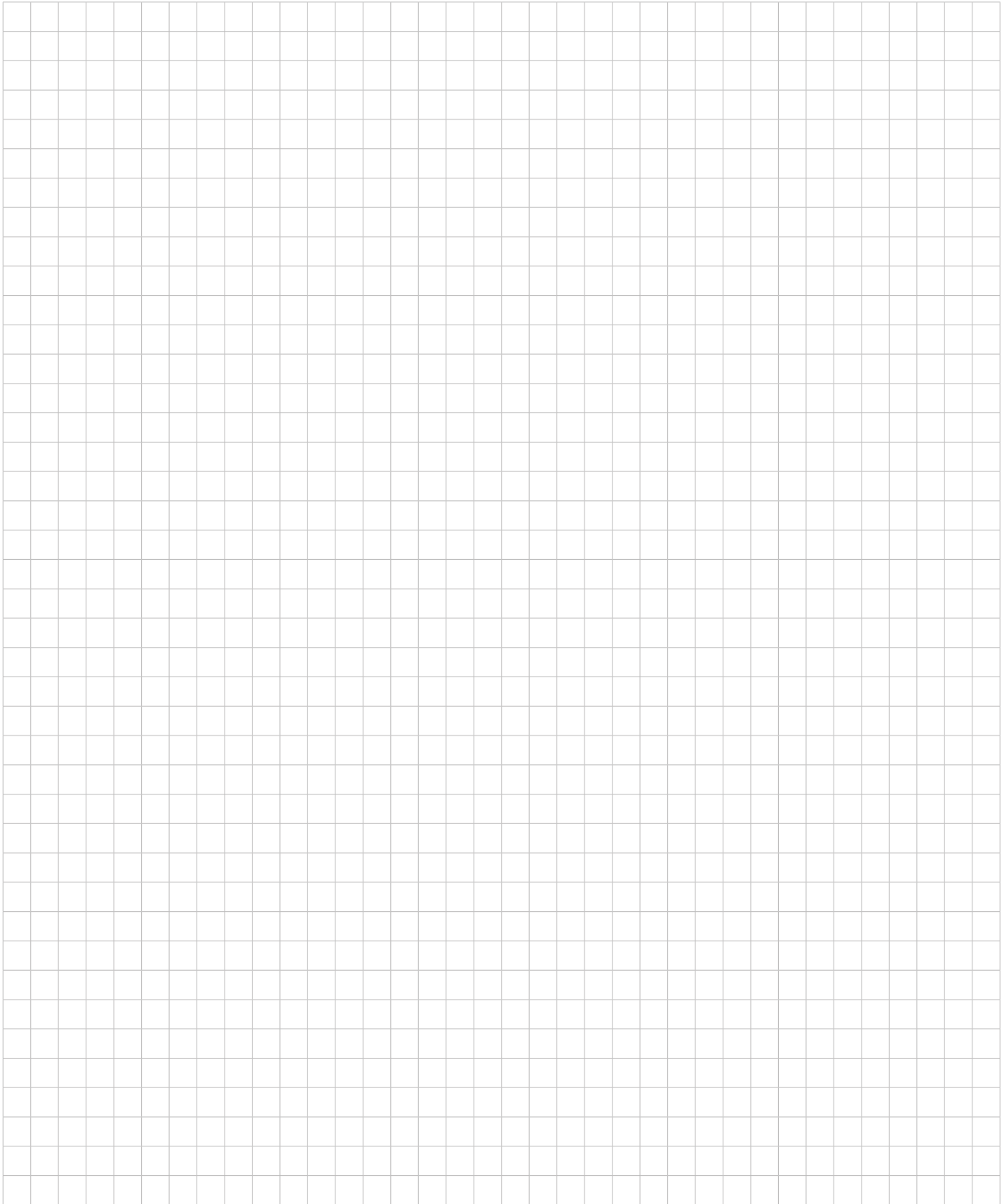

## heimatec.u-tec®

heimatec.com

Products / Tool change systems /  
u-tec® Tool-changing system



versions see catalog

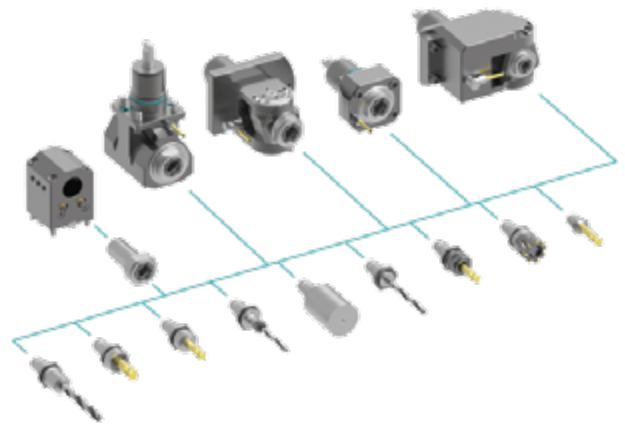

## heimatec.easy-quick

heimatec.com

Products / Tool change systems /  
easy-quick HT quick-changing system



versions see catalog

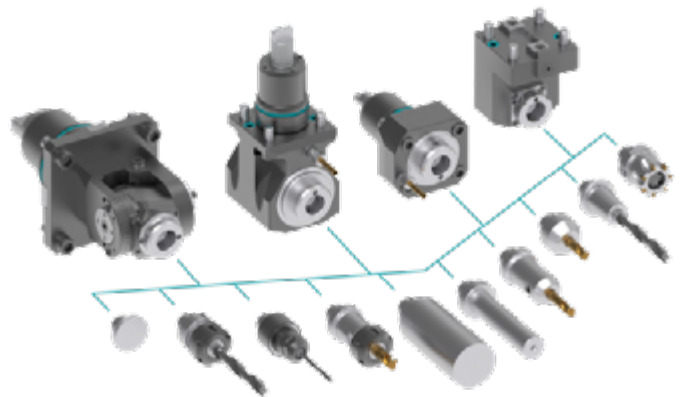

## heimatec.Capto™

heimatec.com

Products / Tool change systems /  
heimatec.Capto™ quick-changing system



versions see catalog

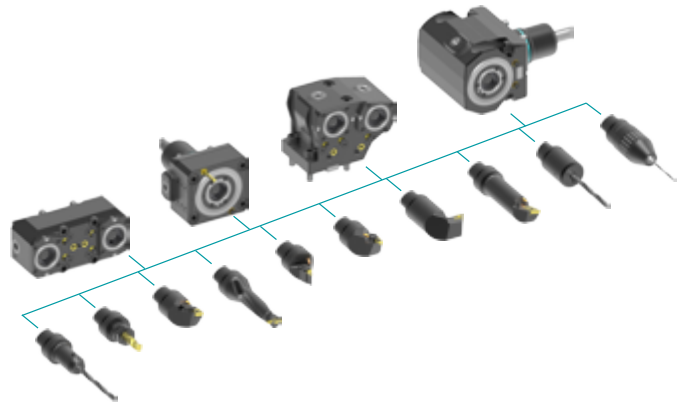

## heimatec.accessories

heimatec.com

Products / Accessories



versions see catalog





● heimatec overseas branches

○ global representations of heimatec

**heimatec**<sup>®</sup>

**heimatec GmbH**  
Präzisionswerkzeuge  
Carl-Benz-Str. 4  
77871 Renchen  
Germany

T +49 7843 9466 0  
[www.heimatec.com](http://www.heimatec.com)  
[info@heimatec.com](mailto:info@heimatec.com)

Please find the contact details of our worldwide trading partners on our website:  
<https://heimatec.com/business-partners>