

Victor
Vturn A 20
SCV/YSCV



High-tech from heimatec - heimatec - Tools and systems for productive turning and milling

heimatec belongs to the international technology and quality leaders for precision tools and specializes in the development and production of high-precision static and live tools for all CNC lathes, CNC turn-/mill machines and CNC machining centers.

The range of products* spans from static BMT and VDI tool holders, live tools up to highly complex customer-specific individual solutions. heimatec, headquartered in Renchen, has a own subsidiary in Asia and India and numerous representatives as well as trading partners all over the world.

*OUR PRODCUTS

Static tool holders

Live tool units

Precision tools

Tools for turning and machining centres

Tools for swiss type lathes

Tool changing and uick-change systems

Tool systems for gear production

Digital tool management

This catalogue, including all its parts, is protected by copyright. Any use outside the restricted limitations of the Copyright Act without the consent of heimatec is inadmissible and liable to prosecution. This applies in particular to duplication, translation, microfilming and storage and processing in electronic systems.





heimatec GmbH reserves the right to make technical changes at any time without giving prior notice. This applies in particular to adjustments at any time to meet new or changed international standards, or in case of further developments of our products or manufacturing processes.

The current version of our General Terms and Conditions can be found on our website.

Victor

Vturn A 20 SCV/YSCV

heimatec®

Part-#	Name	
8 010 25 090	Axial drilling and milling head ER 25	
	Weight [kg]:	1.580
	Tool drive:	DIN 5480
	Shank size [mm]:	30.00
	Shank type:	VDI
	Tool adaption:	ER 25
	Gear ratio [i]:	1:1
	Torque max [Nm]:	25
	Rotation max [1/min]:	6000
	Rotating direction:	same
	Coolant:	EXT
	Please note:	round housing ø 68
8 010 25 091	Axial drilling and milling head ER 25 IC	
	Weight [kg]:	1.830
	Tool drive:	DIN 5480
	Shank size [mm]:	30.00
	Shank type:	VDI
	Tool adaption:	ER 25
	Gear ratio [i]:	1:1
	Torque max [Nm]:	25
	Rotation max [1/min]:	6000
	Rotating direction:	same
	Coolant:	IC/Ext
	Pressure max [bar]:	25
	Please note:	round housing ø 68
8 010 25 118	Axial drilling and milling head ER 25 AX UT	
	Weight [kg]:	1.780
	Tool drive:	DIN 5480
	Shank size [mm]:	30.00
	Shank type:	VDI
	Tool adaption:	ER 25 A - u-tec
	Gear ratio [i]:	1:1
	Torque max [Nm]:	25
	Rotation max [1/min]:	12000
	Rotating direction:	same
	Coolant:	EXT
	Please note:	stronger bearing
8 010 25 119	Axial drilling and milling head ER 25 AX UT IC	
	Weight [kg]:	1.780
	Tool drive:	DIN 5480
	Shank size [mm]:	30.00
	Shank type:	VDI
	Tool adaption:	ER 25 A - u-tec
	Gear ratio [i]:	1:1
	Torque max [Nm]:	25
	Rotation max [1/min]:	6000
	Rotating direction:	same
	Coolant:	IC/Ext
	Pressure max [bar]:	25
	Please note:	round housing ø 68

Part-#	Name	
8 013 22 000	Axial drilling and milling head Weldon 6	
	Version:	left
	Tool drive:	DIN 5480
	Shank size [mm]:	30.00
	Shank type:	VDI
	Tool adaption:	Weldon (DIN 1835 b) 6
	Gear ratio [i]:	1:2
	Torque max [Nm]:	8
	Rotation max [1/min]:	8000
	Rotating direction:	same
	Coolant:	EXT
8 013 24 014	Axial drilling and milling head Weldon 10	
	Version:	left
	Tool drive:	DIN 5480
	Shank size [mm]:	30.00
	Shank type:	VDI
	Tool adaption:	Weldon (DIN 1835 b) 10
	Gear ratio [i]:	1:2
	Torque max [Nm]:	8
	Rotation max [1/min]:	8000
	Rotating direction:	same
	Coolant:	EXT
8 013 25 004	Axial drilling and milling head ER 25	
	Weight [kg]:	4.440
	Version:	left
	Tool drive:	DIN 5480
	Shank size [mm]:	30.00
	Shank type:	VDI
	Tool adaption:	ER 25
	Gear ratio [i]:	2:1
	Torque max [Nm]:	40
	Rotation max [1/min]:	3000
	Rotating direction:	same
	Coolant:	EXT
	Please note:	stronger bearing
8 013 25 007	Axial drilling and milling head Weldon 16	
	Weight [kg]:	4.320
	Version:	left
	Tool drive:	DIN 5480
	Shank size [mm]:	30.00
	Shank type:	VDI
	Tool adaption:	Weldon (DIN 1835 b) 16
	Gear ratio [i]:	1:2
	Torque max [Nm]:	8
	Rotation max [1/min]:	8000
	Rotating direction:	same
	Coolant:	EXT
	Please note:	stronger bearing

Victor

Vturn A 20 SCV/YSCV

heimatec®

Part-#	Name	
8 014 25 002	Axial milling head universal arbor 22	
	Tool drive:	DIN 5480
	Shank size [mm]:	30.00
	Shank type:	VDI
	Tool adaption:	Universal arbor 22
	Gear ratio [i]:	2:1
	Torque max [Nm]:	40
	Rotation max [1/min]:	3000
	Rotating direction:	same
	Coolant:	EXT
	Please note:	stronger bearing
8 018 24 002	Axial drilling and milling head ER 16 AX	
	Weight [kg]:	2.800
	Notation:	Y-axes adjustable ± 21 mm
	Tool drive:	DIN 5480
	Shank size [mm]:	30.00
	Shank type:	VDI
	Tool adaption:	ER 16 A
	Gear ratio [i]:	1:1
	Torque max [Nm]:	16
	Rotation max [1/min]:	6000
	Rotating direction:	opposite
	Coolant:	EXT
8 019 25 008	Axial milling head universal arbor 1"	
	Weight [kg]:	5.300
	Notation:	offset
	Version:	left
	Tool drive:	DIN 5480
	Shank size [mm]:	30.00
	Shank type:	VDI
	Tool adaption:	Universal arbor 1" (25,4mm)
	Gear ratio [i]:	2:1
	Torque max [Nm]:	40
	Rotation max [1/min]:	4000
	Rotating direction:	opposite
	Coolant:	EXT
	Please note:	stronger bearing
	Offset [mm]:	34,5
8 019 25 021	Axial drilling and milling head ER 25	
	Weight [kg]:	4.320
	Notation:	offset
	Version:	left
	Tool drive:	DIN 5480
	Shank size [mm]:	30.00
	Shank type:	VDI
	Tool adaption:	ER 25
	Gear ratio [i]:	1:2
	Torque max [Nm]:	12
	Rotation max [1/min]:	12000
	Rotating direction:	opposite
	Coolant:	EXT
	Please note:	stronger bearing
	Offset [mm]:	34,5

Part-#	Name	
8 019 25 025	Axial milling head universal arbor 22	
	Notation:	offset
	Version:	left
	Tool drive:	DIN 5480
	Shank size [mm]:	30.00
	Shank type:	VDI
	Tool adaption:	Universal arbor 22
	Gear ratio [i]:	2:1
	Torque max [Nm]:	40
	Rotation max [1/min]:	4000
	Rotating direction:	opposite
	Coolant:	EXT
	Please note:	stronger bearing
	Offset [mm]:	34,5
8 019 25 027	Axial drilling and milling head ER 25 IC	
	Weight [kg]:	4.360
	Notation:	offset
	Version:	left
	Tool drive:	DIN 5480
	Shank size [mm]:	30.00
	Shank type:	VDI
	Tool adaption:	ER 25
	Gear ratio [i]:	1:3
	Torque max [Nm]:	6
	Rotation max [1/min]:	15000
	Rotating direction:	opposite
	Coolant:	IC/Ext
	Pressure max [bar]:	25
	Please note:	stronger bearing
	Offset [mm]:	34,5
8 019 26 002	Axial drilling and milling head HT 4 IC	
	Weight [kg]:	4.300
	Notation:	offset
	Version:	right
	Tool drive:	DIN 5480
	Shank size [mm]:	30.00
	Shank type:	VDI
	Tool adaption:	HT 4
	Gear ratio [i]:	1:2
	Torque max [Nm]:	12
	Rotation max [1/min]:	12000
	Rotating direction:	opposite
	Coolant:	IC/Ext
	Pressure max [bar]:	25
	Offset [mm]:	34,5
8 030 25 087	Radial drilling and milling head ER 25	
	Weight [kg]:	3.580
	Version:	left
	Tool drive:	DIN 5480
	Shank size [mm]:	30.00
	Shank type:	VDI
	Tool adaption:	ER 25
	Gear ratio [i]:	1:1
	Torque max [Nm]:	25
	Rotation max [1/min]:	6000

Victor

Vturn A 20 SCV/YSCV

heimatec®

Part-#	Name	
	Rotating direction:	opposite
	Coolant:	EXT
	Center distance [mm]:	85
8 030 25 092	Radial drilling and milling head ER 25	
	Weight [kg]:	3.520
	Version:	right
	Tool drive:	DIN 5480
	Shank size [mm]:	30.00
	Shank type:	VDI
	Tool adaption:	ER 25
	Gear ratio [i]:	1:1
	Torque max [Nm]:	25
	Rotation max [1/min]:	6000
	Rotating direction:	opposite
	Coolant:	EXT
	Center distance [mm]:	85
8 030 25 113	Radial drilling and milling head ER 25	
	Weight [kg]:	4.440
	Version:	right
	Tool drive:	DIN 5480
	Shank size [mm]:	30.00
	Shank type:	VDI
	Tool adaption:	ER 25
	Gear ratio [i]:	1:2
	Torque max [Nm]:	16
	Rotation max [1/min]:	12000
	Rotating direction:	opposite
	Coolant:	EXT
	Center distance [mm]:	85
8 030 25 118	Radial drilling and milling head ER 25 AS IC	
	Version:	left
	Tool drive:	DIN 5480
	Shank size [mm]:	30.00
	Shank type:	VDI
	Tool adaption:	ER 25 A
	Gear ratio [i]:	1:1
	Torque max [Nm]:	32
	Rotation max [1/min]:	6000
	Rotating direction:	opposite
	Coolant:	IC/Ext
	Center distance [mm]:	85
8 030 25 126	Radial drilling and milling head ER 25 IC	
	Weight [kg]:	3.980
	Version:	right
	Tool drive:	DIN 5480
	Shank size [mm]:	30.00
	Shank type:	VDI
	Tool adaption:	ER 25
	Gear ratio [i]:	1:1
	Torque max [Nm]:	25
	Rotation max [1/min]:	6000
	Rotating direction:	opposite
	Coolant:	IC/Ext
	Pressure max [bar]:	140

Part-#	Name	
	Center distance [mm]:	85
8 030 25 136	Radial drilling and milling head ER 25 IC	
	Version:	left
	Tool drive:	DIN 5480
	Shank size [mm]:	30.00
	Shank type:	VDI
	Tool adaption:	ER 25
	Gear ratio [i]:	1:1
	Torque max [Nm]:	25
	Rotation max [1/min]:	6000
	Rotating direction:	opposite
	Coolant:	IC/Ext
	Pressure max [bar]:	140
	Center distance [mm]:	85
8 030 25 242	Radial drilling and milling head ER 25 AX UT	
	Weight [kg]:	3.760
	Version:	right
	Tool drive:	DIN 5480
	Shank size [mm]:	30.00
	Shank type:	VDI
	Tool adaption:	ER 25 A - u-tec
	Gear ratio [i]:	1:1
	Torque max [Nm]:	25
	Rotation max [1/min]:	6000
	Rotating direction:	opposite
	Coolant:	EXT
	Please note:	stronger bearing
	Center distance [mm]:	85
8 030 25 267	Radial drilling and milling head ER 25 AX UT IC	
	Weight [kg]:	4.150
	Version:	right
	Tool drive:	DIN 5480
	Shank size [mm]:	30.00
	Shank type:	VDI
	Tool adaption:	ER 25 A - u-tec
	Gear ratio [i]:	1:1
	Torque max [Nm]:	25
	Rotation max [1/min]:	6000
	Rotating direction:	opposite
	Coolant:	IC/Ext
	Pressure max [bar]:	140
	Please note:	stronger bearing
	Center distance [mm]:	85
8 030 25 323	Radial drilling and milling head ER 25 AX UT	
	Weight [kg]:	3.750
	Version:	left
	Tool drive:	DIN 5480
	Shank size [mm]:	30.00
	Shank type:	VDI
	Tool adaption:	ER 25 A - u-tec
	Gear ratio [i]:	1:1
	Torque max [Nm]:	25
	Rotation max [1/min]:	6000
	Rotating direction:	opposite

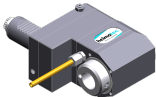
Part-#	Name	
	Coolant:	EXT
	Please note:	stronger bearing
	Center distance [mm]:	85
8 033 26 008	Radial drilling and milling head HT 4	
	Weight [kg]:	4.020
	Notation:	offset
	Version:	left
	Tool drive:	DIN 5480
	Shank size [mm]:	30.00
	Shank type:	VDI
	Tool adaption:	HT 4
	Gear ratio [i]:	1:1
	Torque max [Nm]:	25
	Rotation max [1/min]:	6000
	Rotating direction:	same
	Coolant:	EXT
	Center distance [mm]:	85
8 033 26 015	Radial drilling and milling head HT 4 IC air	
	Weight [kg]:	4.280
	Notation:	offset
	Version:	left
	Tool drive:	DIN 5480
	Shank size [mm]:	30.00
	Shank type:	VDI
	Tool adaption:	HT 4
	Gear ratio [i]:	1:2
	Torque max [Nm]:	8
	Rotation max [1/min]:	10000
	Rotating direction:	same
	Coolant:	IC air
	Pressure max [bar]:	10
	Center distance [mm]:	85
8 036 25 008	Radial drilling and milling head ER 25	
	Weight [kg]:	3.540
	Version:	doubletoothed
	Tool drive:	DIN 5480
	Shank size [mm]:	30.00
	Shank type:	VDI
	Tool adaption:	ER 25
	Gear ratio [i]:	1:1
	Torque max [Nm]:	25
	Rotation max [1/min]:	6000
	Rotating direction:	opposite
	Coolant:	EXT
	Center distance [mm]:	85
8 036 25 038	Radial drilling and milling head ER 25 IC	
	Weight [kg]:	3.940
	Version:	doubletoothed
	Tool drive:	DIN 5480
	Shank size [mm]:	30.00
	Shank type:	VDI
	Tool adaption:	ER 25
	Gear ratio [i]:	1:1

Part-#	Name	
	Torque max [Nm]:	25
	Rotation max [1/min]:	6000
	Rotating direction:	opposite
	Coolant:	IC/Ext
	Pressure max [bar]:	140
	Center distance [mm]:	85
8 036 26 038	Radial drilling and milling head HT 4 IC	
	Notation:	180° reversible
	Version:	doubletoothed
	Tool drive:	DIN 5480
	Shank size [mm]:	30.00
	Shank type:	VDI
	Tool adaption:	HT 4
	Gear ratio [i]:	1:1
	Torque max [Nm]:	25
	Rotation max [1/min]:	6000
	Rotating direction:	opposite
	Coolant:	IC/Ext
	Pressure max [bar]:	140
	Center distance [mm]:	85
8 039 25 054	Radial drilling and milling head ER 25	
	Weight [kg]:	4.070
	Version:	double spindle; doubletoothed
	Tool drive:	DIN 5480
	Shank size [mm]:	30.00
	Shank type:	VDI
	Tool adaption:	ER 25
	Gear ratio [i]:	1:1
	Torque max [Nm]:	25
	Rotation max [1/min]:	6000
	Rotating direction:	same/opposite
	Coolant:	EXT
	Please note:	stronger bearing
	Center distance [mm]:	85
8 039 25 070	Radial drilling and milling head ER 25	
	Weight [kg]:	4.330
	Version:	360° turnable
	Tool drive:	DIN 5480
	Shank size [mm]:	30.00
	Shank type:	VDI
	Tool adaption:	ER 25
	Gear ratio [i]:	1:1
	Torque max [Nm]:	16
	Rotation max [1/min]:	6000
	Rotating direction:	opposite
	Coolant:	EXT
	Please note:	stronger bearing
	Center distance [mm]:	85

Victor

Vturn A 20 SCV/YSCV

heimatec®

Part-#	Name	
8 039 26 025	Radial drilling and milling head HT 4	
	Version:	double spindle; doubletoothed
	Tool drive:	DIN 5480
	Shank size [mm]:	30.00
	Shank type:	VDI
	Tool adaption:	HT 4
	Gear ratio [i]:	1:1
	Torque max [Nm]:	25
	Rotation max [1/min]:	6000
	Rotating direction:	same/opposite
	Coolant:	EXT
	Please note:	stronger bearing
	Center distance [mm]:	85
8 040 24 012	Universal head ± 90° adjustable ER 20	
	Weight [kg]:	2.470
	Version:	right
	Tool drive:	DIN 5480
	Shank size [mm]:	30.00
	Shank type:	VDI
	Tool adaption:	ER 20
	Gear ratio [i]:	1:1
	Torque max [Nm]:	10
	Rotation max [1/min]:	6000
	Rotating direction:	same
	Coolant:	EXT
	Please note:	Fixation 180° reversible
	Center distance [mm]:	64
8 040 24 035	Universal head ± 90° adjustable ER 16	
	Weight [kg]:	2.320
	Version:	right
	Tool drive:	DIN 5480
	Shank size [mm]:	30.00
	Shank type:	VDI
	Tool adaption:	ER 16
	Gear ratio [i]:	1:1
	Torque max [Nm]:	10
	Rotation max [1/min]:	6000
	Rotating direction:	same
	Coolant:	EXT
	Please note:	Fixation 180° reversible
	Center distance [mm]:	64
8 040 24 059	Universal head ± 90° adjustable ER 16 AX UT	
	Weight [kg]:	4.430
	Version:	left
	Tool drive:	DIN 5480
	Shank size [mm]:	30.00
	Shank type:	VDI
	Tool adaption:	ER 16 A - u-tec
	Gear ratio [i]:	1:2
	Torque max [Nm]:	12
	Rotation max [1/min]:	12000
	Rotating direction:	opposite
	Coolant:	EXT
	Center distance [mm]:	88

Part-#	Name
8 040 24 075	Universal head $\pm 90^\circ$ adjustable ER 16 AX UT IC
	Weight [kg]: 4.450
	Version: left
	Tool drive: DIN 5480
	Shank size [mm]: 30.00
	Shank type: VDI
	Tool adaption: ER 16 A - u-tec
	Gear ratio [i]: 1:1
	Torque max [Nm]: 25
	Rotation max [1/min]: 6000
	Rotating direction: opposite
	Coolant: IC/Ext
	Pressure max [bar]: 140
	Center distance [mm]: 88
8 040 24 077	Universal head $\pm 90^\circ$ adjustable ER 16 AX UT
	Version: left
	Tool drive: DIN 5480
	Shank size [mm]: 30.00
	Shank type: VDI
	Tool adaption: ER 16 A - u-tec
	Gear ratio [i]: 1:1
	Torque max [Nm]: 25
	Rotation max [1/min]: 6000
	Rotating direction: opposite
	Coolant: EXT
	Center distance [mm]: 88
8 040 24 078	Universal head $\pm 90^\circ$ adjustable ER 16 AX UT IC
	Version: left
	Tool drive: DIN 5480
	Shank size [mm]: 30.00
	Shank type: VDI
	Tool adaption: ER 16 A - u-tec
	Gear ratio [i]: 1:2
	Torque max [Nm]: 12
	Rotation max [1/min]: 12000
	Rotating direction: opposite
	Coolant: IC/Ext
	Pressure max [bar]: 140
	Center distance [mm]: 88
8 040 24 079	Universal head $\pm 90^\circ$ adjustable ER 16 AX UT
	Version: right
	Tool drive: DIN 5480
	Shank size [mm]: 30.00
	Shank type: VDI
	Tool adaption: ER 16 A - u-tec
	Gear ratio [i]: 1:1
	Torque max [Nm]: 25
	Rotation max [1/min]: 6000
	Rotating direction: opposite
	Coolant: EXT
	Center distance [mm]: 88

Part-#	Name
8 040 24 081	Universal head $\pm 90^\circ$ adjustable ER 16 AX UT IC
	Weight [kg]: 4.450
	Version: right
	Tool drive: DIN 5480
	Shank size [mm]: 30.00
	Shank type: VDI
	Tool adaption: ER 16 A - u-tec
	Gear ratio [i]: 1:1
	Torque max [Nm]: 25
	Rotation max [1/min]: 6000
	Rotating direction: opposite
	Coolant: IC/Ext
	Pressure max [bar]: 140
	Center distance [mm]: 88
8 040 24 084	Universal head $\pm 90^\circ$ adjustable ER 16 AX UT
	Weight [kg]: 4.440
	Version: right
	Tool drive: DIN 5480
	Shank size [mm]: 30.00
	Shank type: VDI
	Tool adaption: ER 16 A - u-tec
	Gear ratio [i]: 1:2
	Torque max [Nm]: 12
	Rotation max [1/min]: 12000
	Rotating direction: opposite
	Coolant: EXT
	Center distance [mm]: 88
8 040 24 087	Universal head $\pm 90^\circ$ adjustable ER 16 AX UT IC
	Version: right
	Tool drive: DIN 5480
	Shank size [mm]: 30.00
	Shank type: VDI
	Tool adaption: ER 16 A - u-tec
	Gear ratio [i]: 1:2
	Torque max [Nm]: 12
	Rotation max [1/min]: 12000
	Rotating direction: opposite
	Coolant: IC/Ext
	Pressure max [bar]: 140
	Center distance [mm]: 88
8 040 24 108	Universal head $\pm 90^\circ$ adjustable ER 16 AX UT
	Weight [kg]: 4.470
	Version: left, at $+45^\circ$ position can be pinned
	Tool drive: DIN 5480
	Shank size [mm]: 30.00
	Shank type: VDI
	Tool adaption: ER 16 A - u-tec
	Gear ratio [i]: 1:2
	Torque max [Nm]: 12
	Rotation max [1/min]: 12000
	Rotating direction: opposite
	Coolant: EXT
	Center distance [mm]: 88

Part-#	Name
8 040 25 021	Universal head $\pm 90^\circ$ adjustable ER 25 AX UT
	Weight [kg]: 4.630
	Version: left
	Tool drive: DIN 5480
	Shank size [mm]: 30.00
	Shank type: VDI
	Tool adaption: ER 25 A - u-tec
	Gear ratio [i]: 1:1
	Torque max [Nm]: 25
	Rotation max [1/min]: 6000
	Rotating direction: opposite
	Coolant: EXT
	Please note: stronger bearing
	Center distance [mm]: 88
8 040 25 022	Universal head $\pm 90^\circ$ adjustable ER 25 AX UT IC
	Weight [kg]: 4.650
	Version: left
	Tool drive: DIN 5480
	Shank size [mm]: 30.00
	Shank type: VDI
	Tool adaption: ER 25 A - u-tec
	Gear ratio [i]: 1:1
	Torque max [Nm]: 25
	Rotation max [1/min]: 6000
	Rotating direction: opposite
	Coolant: IC/Ext
	Pressure max [bar]: 140
	Please note: stronger bearing
	Center distance [mm]: 88
8 040 25 032	Universal head $\pm 90^\circ$ adjustable ER 25 AX UT
	Weight [kg]: 4.660
	Version: right
	Tool drive: DIN 5480
	Shank size [mm]: 30.00
	Shank type: VDI
	Tool adaption: ER 25 A - u-tec
	Gear ratio [i]: 1:1
	Torque max [Nm]: 25
	Rotation max [1/min]: 6000
	Rotating direction: opposite
	Coolant: EXT
	Please note: stronger bearing
	Center distance [mm]: 88
8 040 25 038	Universal head $\pm 90^\circ$ adjustable ER 25 AX UT
	Weight [kg]: 4.890
	Version: right
	Tool drive: DIN 5480
	Shank size [mm]: 30.00
	Shank type: VDI
	Tool adaption: ER 25 A - u-tec
	Gear ratio [i]: 1:1
	Torque max [Nm]: 25
	Rotation max [1/min]: 6000
	Rotating direction: opposite
	Coolant: EXT

Victor

Vturn A 20 SCV/YSCV

heimatec®

Part-#	Name
	Please note: stronger bearing
	Center distance [mm]: 88
8 040 25 040	Universal head ± 90° adjustable ER 25 AX UT IC
	Weight [kg]: 3.500
	Version: right
	Tool drive: DIN 5480
	Shank size [mm]: 30.00
	Shank type: VDI
	Tool adaption: ER 25 A - u-tec
	Gear ratio [i]: 1:1
	Torque max [Nm]: 25
	Rotation max [1/min]: 6000
	Rotating direction: opposite
	Coolant: IC/Ext
	Pressure max [bar]: 140
	Please note: stronger bearing
	Center distance [mm]: 88
8 200 20 000	Plug Z2-30 K
	Weight [kg]: 0.060
	Shank size [mm]: 30.00
	Shank type: VDI
8 200 20 005	Plug Z2-30 S
	Weight [kg]: 0.740
	Shank size [mm]: 30.00
	Shank type: VDI
8 202 20 012	Basic holder longitudinal seat FN 12
	Weight [kg]: 1.160
	Version: universal
	Shank size [mm]: 30.00
	Shank type: VDI
	Tool adaption: Interface FN 12
	Coolant: EXT
8 209 22 000	Adapter for VDI 30
	Weight [kg]: 4.000
	Version: doubletoothed
	Shank size [mm]: 30.00
	Shank type: VDI
	Tool adaption: DIN 69880 - 30
	Coolant: EXT
	Center distance [mm]: 85
8 209 22 006	Adapter for VDI 30
	Weight [kg]: 4.000
	Version: left
	Shank size [mm]: 30.00
	Shank type: VDI
	Tool adaption: DIN 69880 - 30
	Coolant: EXT
	Please note: demountable in right version
	Center distance [mm]: 85

Part-#	Name	
8 210 26 011	Tool holder HT 4 IC	
	Weight [kg]:	1.270
	Version:	right
	Shank size [mm]:	30.00
	Shank type:	VDI
	Tool adaption:	HT 4
	Coolant:	IC/Ext
8 210 26 012	Tool holder HT 4 IC	
	Version:	left
	Shank size [mm]:	30.00
	Shank type:	VDI
	Tool adaption:	HT 4
	Coolant:	IC/Ext
8 214 22 000	Tool holder C1-30x20/16	
	Employment for:	VDI 30
	Version:	right
	Shank size [mm]:	30.00
	Shank type:	VDI
	Tool adaption:	Sq. 20/16
	Coolant:	EXT
8 214 22 001	Tool holder C3-30x20/16	
	Employment for:	VDI 30
	Version:	right
	Shank size [mm]:	30.00
	Shank type:	VDI
	Tool adaption:	Sq. 20/16
	Coolant:	EXT
8 215 22 000	Tool holder C2-30x20	
	Weight [kg]:	1.980
	Employment for:	VDI 30
	Version:	left
	Shank size [mm]:	30.00
	Shank type:	VDI
	Tool adaption:	Sq. 20/16
	Coolant:	EXT
8 215 22 001	Tool holder C4-30x20	
	Employment for:	VDI 30
	Version:	left
	Shank type:	VDI
	Tool adaption:	Sq. 20/16
	Coolant:	EXT
8 230 25 005	Collet chuck holder ER 25	
	Version:	right
	Shank size [mm]:	30.00
	Shank type:	VDI
	Tool adaption:	ER 25
	Coolant:	IC/Ext
	Please note:	demountable in left version
	Center distance [mm]:	85

Part-#	Name	
8 230 25 016	Boring bar holder Ø 16	
	Employment for:	Main- and sub spindle
	Version:	right / left
	Shank size [mm]:	30.00
	Shank type:	VDI
	Tool adaption:	Ø 16
	Coolant:	IC/Ext
	Please note:	demountable in left version
	Center distance [mm]:	85
8 230 25 020	Collet chuck holder ER 25	
	Employment for:	Heavy duty cutting
	Version:	right
	Shank size [mm]:	30.00
	Shank type:	VDI
	Tool adaption:	ER 25
	Coolant:	IC/Ext
	Please note:	demountable in left version
	Center distance [mm]:	85
8 230 26 027	Boring bar holder Ø 20	
	Version:	right
	Shank size [mm]:	30.00
	Shank type:	VDI
	Tool adaption:	Ø 20
	Coolant:	IC/Ext
	Please note:	demountable in left version
	Center distance [mm]:	85
8 230 26 030	Tool holder HT 4	
	Version:	right
	Shank size [mm]:	30.00
	Shank type:	VDI
	Tool adaption:	HT 4
	Coolant:	IC/Ext
	Please note:	demountable in left version
	Center distance [mm]:	85
8 230 26 033	Collet chuck holder ER 32	
	Employment for:	Heavy duty cutting
	Version:	right
	Shank size [mm]:	30.00
	Shank type:	VDI
	Tool adaption:	ER 32
	Coolant:	IC/Ext
	Please note:	demountable in left version
	Center distance [mm]:	85
8 230 26 037	Tool holder HT 4	
	Employment for:	Heavy duty cutting
	Version:	right
	Shank size [mm]:	30.00
	Shank type:	VDI
	Tool adaption:	HT 4
	Coolant:	IC/Ext
	Please note:	demountable in left version
	Center distance [mm]:	85

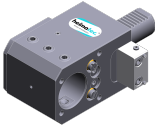
Part-#	Name	
8 230 27 032	Boring bar holder Ø 25	
	Employment for:	Heavy duty cutting
	Version:	right
	Shank size [mm]:	30.00
	Shank type:	VDI
	Tool adaption:	Ø 25
	Coolant:	IC/Ext
	Please note:	demountable in left version
	Center distance [mm]:	85
8 230 27 057	Boring bar holder Ø 25	
	Weight [kg]:	4.110
	Version:	right
	Shank size [mm]:	30.00
	Shank type:	VDI
	Tool adaption:	Ø 25
	Coolant:	IC/Ext
	Please note:	demountable in left version
	Center distance [mm]:	85
8 230 28 022	Boring bar holder Ø 32	
	Version:	right
	Shank size [mm]:	30.00
	Shank type:	VDI
	Tool adaption:	Ø 32
	Coolant:	IC/Ext
	Please note:	demountable in left version
	Center distance [mm]:	85
8 230 28 030	Boring bar holder Ø 32	
	Weight [kg]:	3.710
	Employment for:	Heavy duty cutting
	Version:	right
	Shank size [mm]:	30.00
	Shank type:	VDI
	Tool adaption:	Ø 32
	Coolant:	IC/Ext
	Please note:	demountable in left version
	Center distance [mm]:	85
8 230 29 003	Boring bar holder Ø 40	
	Weight [kg]:	3.900
	Version:	right
	Shank size [mm]:	30.00
	Shank type:	VDI
	Tool adaption:	Ø 40
	Coolant:	IC/Ext
	Please note:	demountable in left version
	Center distance [mm]:	85
8 231 26 016	Tool holder HT 4	
	Weight [kg]:	3.480
	Version:	left
	Shank size [mm]:	30.00
	Shank type:	VDI
	Tool adaption:	HT 4
	Coolant:	IC/Ext

Victor

Vturn A 20 SCV/YSCV

heimatec®

Part-#	Name	
	Please note:	demountable in right version
	Center distance [mm]:	85
8 231 26 019	Collet chuck holder ER 32	
	Employment for:	Heavy duty cutting
	Version:	left
	Shank size [mm]:	30.00
	Shank type:	VDI
	Tool adaption:	ER 32
	Coolant:	IC/Ext
	Please note:	demountable in right version
	Center distance [mm]:	85
8 231 26 023	Tool holder HT 4	
	Employment for:	Heavy duty cutting
	Version:	left
	Shank size [mm]:	30.00
	Shank type:	VDI
	Tool adaption:	HT 4
	Coolant:	IC/Ext
	Please note:	demountable in right version
	Center distance [mm]:	85
8 231 27 004	Boring bar holder Ø 25	
	Weight [kg]:	3.400
	Version:	left
	Shank size [mm]:	30.00
	Shank type:	VDI
	Tool adaption:	Ø 25
	Coolant:	IC/Ext
	Please note:	demountable in right version
	Center distance [mm]:	85
8 231 27 009	Boring bar holder Ø 25	
	Employment for:	Heavy duty cutting
	Version:	left
	Shank size [mm]:	30.00
	Shank type:	VDI
	Tool adaption:	Ø 25
	Coolant:	IC/Ext
	Please note:	demountable in right version
	Center distance [mm]:	85
8 231 28 010	Boring bar holder Ø 32	
	Employment for:	Heavy duty cutting
	Version:	left
	Shank size [mm]:	30.00
	Shank type:	VDI
	Tool adaption:	Ø 32
	Coolant:	IC/Ext
	Please note:	demountable in right version
	Center distance [mm]:	85

Part-#	Name	
8 231 28 023	Boring bar holder Ø 32	
	Weight [kg]:	3.720
	Employment for:	Heavy duty cutting
	Version:	left
	Shank size [mm]:	30.00
	Shank type:	VDI
	Tool adaption:	Ø 32
	Coolant:	IC/Ext
	Please note:	demountable in right version
	Center distance [mm]:	85
8 231 29 009	Boring bar holder Ø 40	
	Employment for:	Heavy duty cutting
	Version:	left
	Shank size [mm]:	30.00
	Shank type:	VDI
	Tool adaption:	Ø 40
	Coolant:	IC/Ext
	Please note:	demountable in right version
	Center distance [mm]:	85
8 234 22 000	Tool holder B3-30x20x40	
	Employment for:	VDI 30
	Shank size [mm]:	30.00
	Shank type:	VDI
	Tool adaption:	Sq. 20/16
	Coolant:	EXT
8 234 22 001	Tool holder B1-30x20x40	
	Employment for:	VDI 30
	Version:	right
	Shank size [mm]:	30.00
	Shank type:	VDI
	Tool adaption:	Sq. 20/16
	Coolant:	EXT
8 234 22 002	Tool holder B5-30x20x40	
	Weight [kg]:	1.790
	Shank size [mm]:	30.00
	Shank type:	VDI
	Tool adaption:	Sq. 20/16
	Coolant:	EXT
8 234 22 003	Tool holder B1-30x20x60	
	Employment for:	VDI 30
	Version:	right
	Shank size [mm]:	30.00
	Shank type:	VDI
	Tool adaption:	Sq. 20/16
	Coolant:	EXT
8 234 22 004	Tool holder B3-30x20x60	
	Employment for:	VDI 30
	Shank size [mm]:	30.00
	Shank type:	VDI
	Tool adaption:	Sq. 20/16
	Coolant:	EXT

Victor

Vturn A 20 SCV/YSCV

heimatec®

Part-#	Name	
8 234 22 005	Tool holder B5-30x20x60	
	Shank size [mm]:	30.00
	Shank type:	VDI
	Tool adaption:	Sq. 20/16
	Coolant:	EXT
8 234 22 006	Tool holder B7-30x20x40	
	Weight [kg]:	1.960
	Shank size [mm]:	30.00
	Shank type:	VDI
	Tool adaption:	Sq. 20/16
	Coolant:	EXT
8 234 22 007	Tool holder B7-30x20x60	
	Weight [kg]:	2.880
	Employment for:	VDI 30
	Shank size [mm]:	30.00
	Shank type:	VDI
	Tool adaption:	Sq. 20/16
	Coolant:	EXT
8 234 22 014	Tool holder B1-30x20x80 special	
	Shank size [mm]:	30.00
	Shank type:	VDI
	Tool adaption:	Sq. 20/16
	Coolant:	EXT
8 234 22 015	Tool holder B1-30x20x90 special	
	Shank size [mm]:	30.00
	Shank type:	VDI
	Tool adaption:	Sq. 20/16
	Coolant:	EXT
8 234 24 003	Combi facing holder 30x20x 92	
	Weight [kg]:	4.750
	Shank size [mm]:	30.00
	Shank type:	VDI
	Tool adaption:	Sq. 20
	Coolant:	EXT
8 235 22 000	Tool holder B2-30x20x40	
	Employment for:	VDI 30
	Version:	left
	Shank size [mm]:	30.00
	Shank type:	VDI
	Tool adaption:	Sq. 20/16
	Coolant:	EXT
8 235 22 001	Tool holder B2-30x20x60	
	Employment for:	VDI 30
	Version:	left
	Shank size [mm]:	30.00
	Shank type:	VDI
	Tool adaption:	Sq. 20/16
	Coolant:	EXT

Victor

Vturn A 20 SCV/YSCV

heimatec®

Part-#	Name	
8 235 22 002	Tool holder B4-30x20x40	
	Weight [kg]:	1.360
	Employment for:	VDI 30
	Version:	left
	Shank size [mm]:	30.00
	Shank type:	VDI
	Tool adaption:	Sq. 20/16
	Coolant:	EXT
8 235 22 003	Tool holder B4-30x20x60	
	Employment for:	VDI 30
	Version:	left
	Shank size [mm]:	30.00
	Shank type:	VDI
	Tool adaption:	Sq. 20/16
	Coolant:	EXT
8 235 22 004	Tool holder B6-30x20x40	
	Weight [kg]:	1.860
	Version:	Left
	Shank size [mm]:	30.00
	Shank type:	VDI
	Tool adaption:	Sq. 20/16
	Coolant:	EXT
8 235 22 005	Tool holder B6-30x20x60	
	Weight [kg]:	2.450
	Version:	Left
	Shank size [mm]:	30.00
	Shank type:	VDI
	Tool adaption:	Sq. 20/16
	Coolant:	EXT
8 235 22 006	Tool holder B8-30x20x40	
	Weight [kg]:	1.880
	Version:	Left
	Shank size [mm]:	30.00
	Shank type:	VDI
	Tool adaption:	Sq. 20/16
	Coolant:	EXT
8 235 22 007	Tool holder B8-30x20x60	
	Version:	Left
	Shank size [mm]:	30.00
	Shank type:	VDI
	Tool adaption:	Sq. 20/16
	Coolant:	EXT
8 239 25 014	Double collet chuck holder ER 25	
	Shank size [mm]:	30.00
	Shank type:	VDI
	Tool adaption:	ER 25
	Coolant:	IC/Ext
	Center distance [mm]:	85

Part-#	Name	
8 239 25 019	Double collet chuck holder ER 25	
	Employment for:	Heavy duty cutting
	Shank size [mm]:	30.00
	Shank type:	VDI
	Tool adaption:	ER 25
	Coolant:	IC/Ext
	Center distance [mm]:	85
8 239 26 017	Double tool holder HT 4	
	Shank size [mm]:	30.00
	Shank type:	VDI
	Tool adaption:	HT 4
	Coolant:	IC/Ext
	Center distance [mm]:	85
8 239 26 023	Double tool holder HT 4	
	Employment for:	Heavy duty cutting
	Shank size [mm]:	30.00
	Shank type:	VDI
	Tool adaption:	HT 4
	Coolant:	IC/Ext
	Center distance [mm]:	85
8 239 27 012	Double boring bar holder Ø 25	
	Weight [kg]:	5.500
	Employment for:	Heavy duty cutting
	Shank size [mm]:	30.00
	Shank type:	VDI
	Tool adaption:	Ø 25
	Coolant:	IC/Ext
	Center distance [mm]:	85
8 239 28 002	Double boring bar holder Ø 32	
	Weight [kg]:	5.570
	Shank size [mm]:	30.00
	Shank type:	VDI
	Tool adaption:	Ø 32
	Coolant:	IC/Ext
	Center distance [mm]:	85
8 239 28 010	Double boring bar holder Ø 32	
	Employment for:	Heavy duty cutting
	Shank size [mm]:	30.00
	Shank type:	VDI
	Tool adaption:	Ø 32
	Coolant:	IC/Ext
	Center distance [mm]:	85
8 251 24 002	Combi double turning holder sq. 20	
	Weight [kg]:	4.600
	Shank size [mm]:	30.00
	Shank type:	VDI
	Tool adaption:	Sq. 20
	Coolant:	EXT

Part-#	Name	
8 253 28 005	Double boring bar holder Ø 32	
	Weight [kg]:	4.660
	Shank size [mm]:	30.00
	Shank type:	VDI
	Tool adaption:	Ø 32
		Ø 32
	Coolant:	IC/Ext
	Center distance [mm]:	60/102
8 262 29 011	Stock stop VDI 30 - Ø 60 OD turret	
	Weight [kg]:	4.540
	Notation:	rotating
	Version:	right
	Shank size [mm]:	30.00
	Shank type:	VDI
	Please note:	Length adjustable
	Center distance [mm]:	85
8 274 22 000	Tool holder D2-30x20	
	Weight [kg]:	2.220
	Shank size [mm]:	30.00
	Shank type:	VDI
	Tool adaption:	Sq. 20/16
	Coolant:	EXT
8 274 22 001	Tool holder D1-30x20	
	Weight [kg]:	2.040
	Shank size [mm]:	30.00
	Shank type:	VDI
	Tool adaption:	Sq. 20/16
	Coolant:	EXT
8 320 22 019	Cut-off holder, height adjustable SH 26 IC	
	Weight [kg]:	1.510
	Version:	universal
	Shank size [mm]:	30.00
	Shank type:	VDI
	Tool adaption:	Clampshaft SH 26
	Coolant:	IC/Ext
	Pressure max [bar]:	70
8 320 23 013	Cut-off holder, height adjustable SH 32 IC	
	Weight [kg]:	1.720
	Version:	universal
	Shank size [mm]:	30.00
	Shank type:	VDI
	Tool adaption:	Clampshaft SH 32
	Coolant:	IC/Ext
	Pressure max [bar]:	70
8 320 23 018	Cut-off holder, height adjustable SH 32 IC	
	Weight [kg]:	1.910
	Version:	universal
	Shank size [mm]:	30.00
	Shank type:	VDI
	Tool adaption:	Clampshaft SH 32
	Coolant:	IC/Ext

Victor

Vturn A 20 SCV/YSCV

heimatec®

Part-#	Name	
	Pressure max [bar]:	70
	Please note:	Clampshaft internal
8 320 23 038	Cut-off holder, height adjustable SH 32 IC	
	Weight [kg]:	1.900
	Version:	universal
	Shank size [mm]:	30.00
	Shank type:	VDI
	Tool adaption:	Clampshaft SH 32
	Coolant:	IC/Ext
	Pressure max [bar]:	70
	Please note:	Clampshaft internal, check applicability!
8 320 29 002	Cut-off holder, height adjustable 845 IC	
	Weight [kg]:	1.630
	Version:	universal
	Shank size [mm]:	30.00
	Shank type:	VDI
	Tool adaption:	 System 845
	Coolant:	IC
	Pressure max [bar]:	70

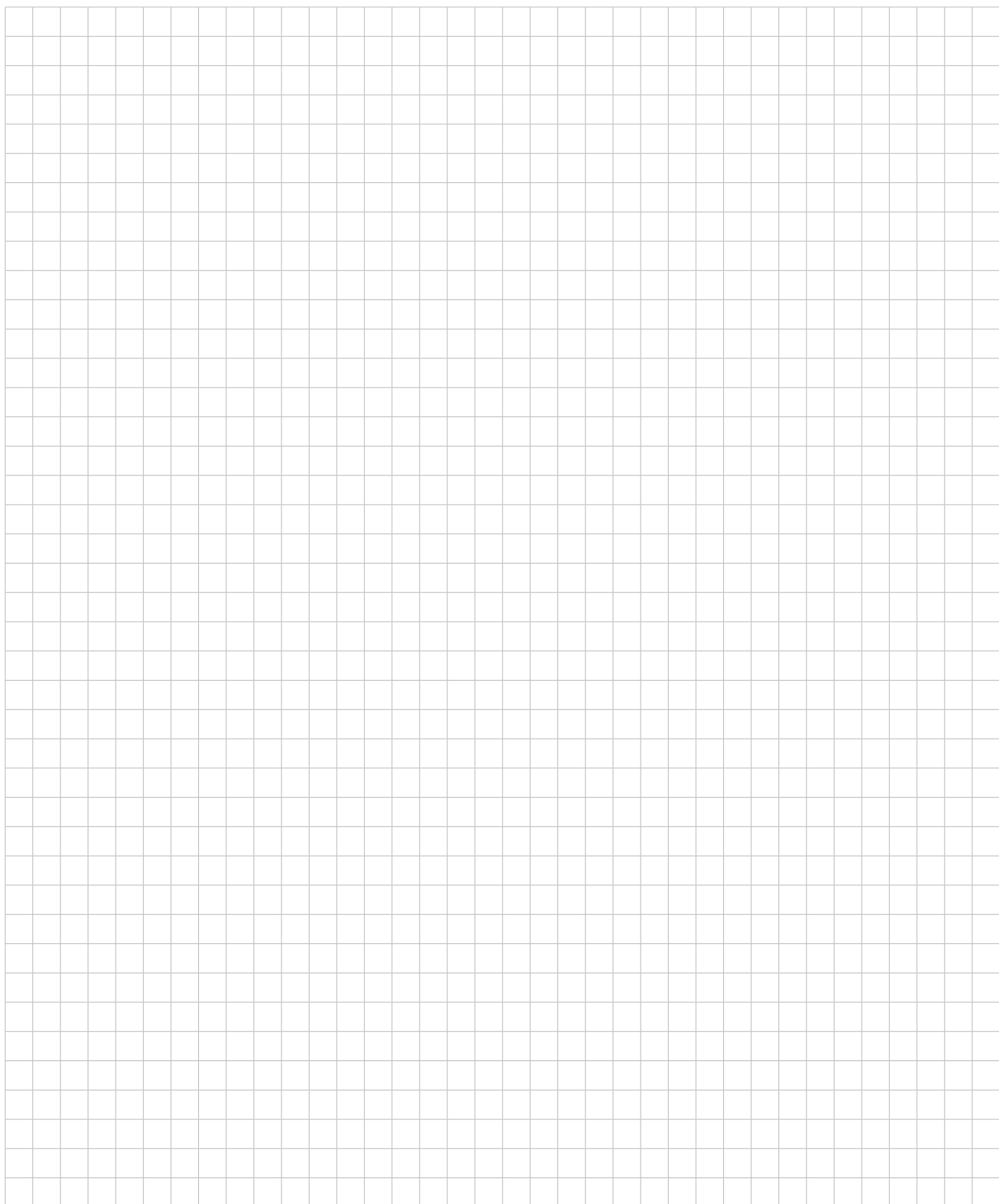

heimatec.u-tec®

heimatec.com

Products / Tool change systems /
u-tec® Tool-changing system



versions see catalog

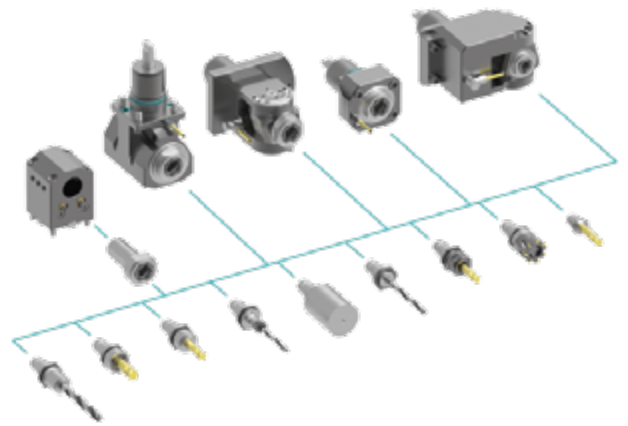

heimatec.easy-quick

heimatec.com

Products / Tool change systems /
easy-quick HT quick-changing system



versions see catalog

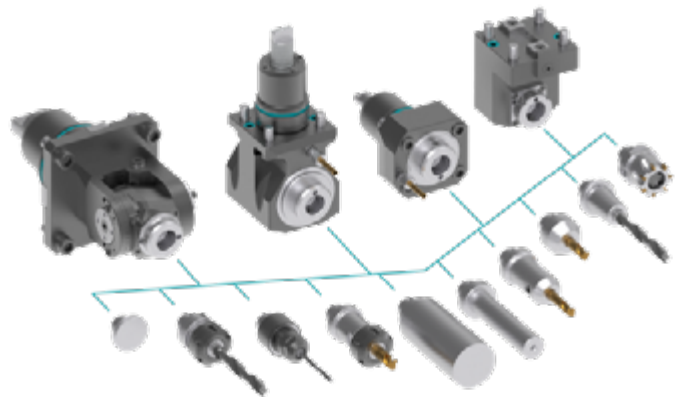

heimatec.Capto™

heimatec.com

Products / Tool change systems /
heimatec.Capto™ quick-changing system



versions see catalog

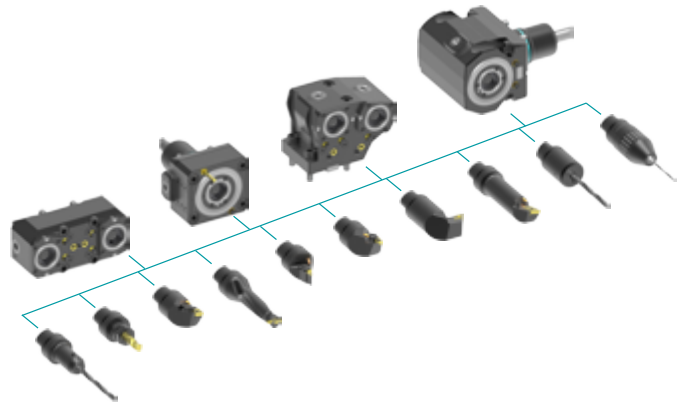

heimatec.accessories

heimatec.com

Products / Accessories



versions see catalog





● heimatec overseas branches

○ global representations of heimatec

heimatec[®]

heimatec GmbH
Präzisionswerkzeuge
Carl-Benz-Str. 4
77871 Renchen
Germany

T +49 7843 9466 0
www.heimatec.com
info@heimatec.com

Please find the contact details of our worldwide trading partners on our website:
<https://heimatec.com/business-partners>