

SPINNER

TTS 65 - BMT 45



High-tech from heimatec - heimatec - Tools and systems for productive turning and milling

heimatec belongs to the international technology and quality leaders for precision tools and specializes in the development and production of high-precision static and live tools for all CNC lathes, CNC turn-/mill machines and CNC machining centers.

The range of products* spans from static BMT and VDI tool holders, live tools up to highly complex customer-specific individual solutions. heimatec, headquartered in Renchen, has a own subsidiary in Asia and India and numerous representatives as well as trading partners all over the world.

*OUR PRODCUTS

Static tool holders

Live tool units

Precision tools

Tools for turning and machining centres

Tools for swiss type lathes

Tool changing and uick-change systems

Tool systems for gear production

Digital tool management

This catalogue, including all its parts, is protected by copyright. Any use outside the restricted limitations of the Copyright Act without the consent of heimatec is inadmissible and liable to prosecution. This applies in particular to duplication, translation, microfilming and storage and processing in electronic systems.

heimatec GmbH reserves the right to make technical changes at any time without giving prior notice. This applies in particular to adjustments at any time to meet new or changed international standards, or in case of further developments of our products or manufacturing processes.

The current version of our General Terms and Conditions can be found on our website.

SPINNER

TTS 65 - BMT 45

Part-#	Name
--------	------

8 010 45 126



Axial milling and drill holder ER 25 AX UT

Weight [kg]: 1.680
 Tool drive: Flat (~DIN 1809)
 Shank size [mm]: 45.00
 Shank type: BMT
 Tool adaption: ER 25 A - u-tec
 Gear ratio [i]: 1:1
 Torque max [Nm]: 32
 Rotation max [1/min]: 6000
 Rotating direction: same
 Coolant: EXT
 Pressure max [bar]: 140
 Please note: Combi bearing

8 010 45 135



Axial drilling and milling head ER 25 AX UT

Weight [kg]: 1.710
 Tool drive: Flat (~DIN 1809)
 Shank size [mm]: 45.00
 Shank type: BMT
 Tool adaption: ER 25 A - u-tec
 Gear ratio [i]: 1:1
 Torque max [Nm]: 50
 Rotation max [1/min]: 15000
 Rotating direction: same
 Coolant: EXT

8 010 45 138

Axial drilling and milling head C 3 IC

Weight [kg]: 3.080
 Notation: 180° reversible
 Tool drive: Flat (~DIN 1809)
 Shank size [mm]: 45.00
 Shank type: BMT
 Tool adaption: heimatec Capto(TM) C 3
 Gear ratio [i]: 1:1
 Torque max [Nm]: 25
 Rotation max [1/min]: 8000
 Rotating direction: same
 Coolant: IC/Ext
 Pressure max [bar]: 25
 Please note: Check applicability; tool length check!

8 010 45 182



Axial drilling and milling head C 3

Weight [kg]: 2.880
 Notation: 180° reversible
 Tool drive: Flat (~DIN 1809)
 Shank size [mm]: 45.00
 Shank type: BMT
 Tool adaption: heimatec Capto(TM) C 3
 Gear ratio [i]: 1:1
 Torque max [Nm]: 32
 Rotation max [1/min]: 8000
 Rotating direction: same
 Coolant: EXT
 Please note: Check applicability; tool length check!

SPINNER

TTS 65 - BMT 45

Part-#	Name	
8 010 46 230	Axial drilling and milling head HT 4	
	Tool drive:	Flat (~DIN 1809)
	Shank size [mm]:	45.00
	Shank type:	BMT
	Tool adaption:	HT 4
	Gear ratio [i]:	1:1
	Torque max [Nm]:	32
	Rotation max [1/min]:	8000
	Rotating direction:	same
	Coolant:	EXT
8 010 46 231	Axial drilling and milling head HT 4 IC	
	Weight [kg]:	2.000
	Tool drive:	Flat (~DIN 1809)
	Shank size [mm]:	45.00
	Shank type:	BMT
	Tool adaption:	HT 4
	Gear ratio [i]:	1:1
	Torque max [Nm]:	32
	Rotation max [1/min]:	6000
	Rotating direction:	same
	Coolant:	IC/Ext
	Pressure max [bar]:	25
	Please note:	Combi bearing
8 010 47 136	Axial drilling and milling head HT 5 IC	
	Weight [kg]:	2.000
	Tool drive:	Flat (~DIN 1809)
	Shank size [mm]:	45.00
	Shank type:	BMT
	Tool adaption:	HT 5
	Gear ratio [i]:	1:1
	Torque max [Nm]:	32
	Rotation max [1/min]:	6000
	Rotating direction:	same
	Coolant:	IC/Ext
	Pressure max [bar]:	25
	Please note:	Combi bearing
8 011 45 034	Axial milling head universal arbor 22	
	Weight [kg]:	1.980
	Tool drive:	Flat (~DIN 1809)
	Shank size [mm]:	45.00
	Shank type:	BMT
	Tool adaption:	Universal arbor 22
	Gear ratio [i]:	1:1
	Torque max [Nm]:	32
	Rotation max [1/min]:	6000
	Rotating direction:	same
	Coolant:	EXT
	Please note:	Combi bearing

SPINNER

TTS 65 - BMT 45

Part-#	Name
--------	------

8 013 44 014



Axial drilling and milling head ER 16 AX UT

Weight [kg]: 2.300
 Tool drive: Flat (~DIN 1809)
 Shank size [mm]: 45.00
 Shank type: BMT
 Tool adaption: ER 16 A - u-tec
 Gear ratio [i]: 1:4
 Torque max [Nm]: 5
 Rotation max [1/min]: 24000
 Rotating direction: same
 Coolant: EXT

8 013 44 015



Axial drilling and milling head ER 16 AX UT IC

Tool drive: Flat (~DIN 1809)
 Shank size [mm]: 45.00
 Shank type: BMT
 Tool adaption: ER 16 A - u-tec
 Gear ratio [i]: 1:4
 Torque max [Nm]: 5
 Rotation max [1/min]: 24000
 Rotating direction: same
 Coolant: IC/Ext
 Pressure max [bar]: 80

8 019 45 147

Axial drilling and milling head ER 25 AX UT

Weight [kg]: 4.400
 Notation: offset; 180° reversible
 Tool drive: Flat (~DIN 1809)
 Shank size [mm]: 45.00
 Shank type: BMT
 Tool adaption: ER 25 A - u-tec
 Gear ratio [i]: 1:2
 Torque max [Nm]: 25
 Rotation max [1/min]: 12000
 Rotating direction: opposite
 Coolant: EXT
 Please note: stronger bearing
 Offset [mm]: 42

8 019 45 148

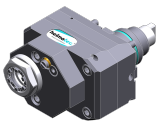

Axial drilling and milling head ER 25 AX UT IC

Weight [kg]: 5.300
 Notation: offset; 180° reversible
 Tool drive: Flat (~DIN 1809)
 Shank size [mm]: 45.00
 Shank type: BMT
 Tool adaption: ER 25 A - u-tec
 Gear ratio [i]: 1:2
 Torque max [Nm]: 25
 Rotation max [1/min]: 12000
 Rotating direction: opposite
 Coolant: IC/Ext
 Pressure max [bar]: 140
 Please note: stronger bearing
 Offset [mm]: 42

SPINNER

TTS 65 - BMT 45

Part-#	Name
--------	------

8 019 45 149

Axial drilling and milling head ER 25 AX UT



Notation: offset; 180° reversible
 Tool drive: Flat (~DIN 1809)
 Shank size [mm]: 45.00
 Shank type: BMT
 Tool adaption: ER 25 A - u-tec
 Gear ratio [i]: 1:3
 Torque max [Nm]: 16
 Rotation max [1/min]: 18000
 Rotating direction: opposite
 Coolant: EXT
 Please note: stronger bearing
 Offset [mm]: 42

8 019 45 150

Axial drilling and milling head ER 25 AX UT IC



Weight [kg]: 5.480
 Notation: offset; 180° reversible
 Tool drive: Flat (~DIN 1809)
 Shank size [mm]: 45.00
 Shank type: BMT
 Tool adaption: ER 25 A - u-tec
 Gear ratio [i]: 1:3
 Torque max [Nm]: 16
 Rotation max [1/min]: 18000
 Rotating direction: opposite
 Coolant: IC/Ext
 Pressure max [bar]: 140
 Please note: stronger bearing
 Offset [mm]: 42

8 019 45 152

Axial drilling and milling head ER 25 AX UT IC

Notation: offset; 180° reversible
 Tool drive: Flat (~DIN 1809)
 Shank size [mm]: 45.00
 Shank type: BMT
 Tool adaption: ER 25 A - u-tec
 Gear ratio [i]: 2:1
 Torque max [Nm]: 50
 Rotation max [1/min]: 3000
 Rotating direction: opposite
 Coolant: IC/Ext
 Pressure max [bar]: 140
 Please note: stronger bearing
 Offset [mm]: 42

8 019 45 191

Axial drilling and milling head ER 25 AX UT

Notation: offset; 180° reversible
 Tool drive: Flat (~DIN 1809)
 Shank size [mm]: 45.00
 Shank type: BMT
 Tool adaption: ER 25 A - u-tec
 Gear ratio [i]: 2:1
 Torque max [Nm]: 50
 Rotation max [1/min]: 3000
 Rotating direction: opposite
 Coolant: EXT
 Please note: stronger bearing

SPINNER

TTS 65 - BMT 45

Part-#	Name
--------	------

Offset [mm]: 42

8 030 44 092



Radial drilling and milling head ER 16 AX UT
 Notation: 180° reversible
 Tool drive: Flat (~DIN 1809)
 Shank size [mm]: 45.00
 Shank type: BMT
 Tool adaption: ER 16 A - u-tec
 Gear ratio [i]: 1:4
 Torque max [Nm]: 5
 Rotation max [1/min]: 24000
 Rotating direction: opposite
 Coolant: EXT
 Pressure max [bar]: 140
 Center distance [mm]: 85

8 030 44 093



Radial drilling and milling head ER 16 AX UT IC
 Notation: 180° reversible
 Tool drive: Flat (~DIN 1809)
 Shank size [mm]: 45.00
 Shank type: BMT
 Tool adaption: ER 16 A - u-tec
 Gear ratio [i]: 1:4
 Torque max [Nm]: 5
 Rotation max [1/min]: 24000
 Rotating direction: opposite
 Coolant: IC/Ext
 Pressure max [bar]: 140
 Center distance [mm]: 85

8 030 45 262

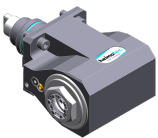

Angle-mill- and drill holder ER 25 AX UT
 Weight [kg]: 6.300
 Notation: 180° reversible
 Tool drive: Flat (~DIN 1809)
 Shank size [mm]: 45.00
 Shank type: BMT
 Tool adaption: ER 25 A - u-tec
 Gear ratio [i]: 1:1
 Torque max [Nm]: 50
 Rotation max [1/min]: 6000
 Rotating direction: opposite
 Coolant: EXT
 Please note: Combi bearing
 Center distance [mm]: 85

8 030 45 263



Angle-mill- and drill holder ER 25 AX UT IC
 Weight [kg]: 6.700
 Notation: 180° reversible
 Tool drive: Flat (~DIN 1809)
 Shank size [mm]: 45.00
 Shank type: BMT
 Tool adaption: ER 25 A - u-tec
 Gear ratio [i]: 1:1
 Torque max [Nm]: 50
 Rotation max [1/min]: 6000
 Rotating direction: opposite

SPINNER

TTS 65 - BMT 45

Part-#	Name	
	Coolant:	IC/Ext
	Pressure max [bar]:	140
	Please note:	Combi bearing
	Center distance [mm]:	85
8 030 45 266	Radial drilling and milling head ER 25 AX UT	
	Weight [kg]:	5.940
	Notation:	180° reversible
	Tool drive:	Flat (~DIN 1809)
	Shank size [mm]:	45.00
	Shank type:	BMT
	Tool adaption:	ER 25 A - u-tec
	Gear ratio [i]:	1:2
	Torque max [Nm]:	16
	Rotation max [1/min]:	12000
	Rotating direction:	same
	Coolant:	EXT
	Please note:	stronger bearing
	Center distance [mm]:	85
8 030 45 267	Radial drilling and milling head ER 25 AX UT IC	
	Weight [kg]:	6.190
	Notation:	180° reversible
	Tool drive:	Flat (~DIN 1809)
	Shank size [mm]:	45.00
	Shank type:	BMT
	Tool adaption:	ER 25 A - u-tec
	Gear ratio [i]:	1:2
	Torque max [Nm]:	16
	Rotation max [1/min]:	12000
	Rotating direction:	same
	Coolant:	IC/Ext
	Pressure max [bar]:	140
	Please note:	stronger bearing
	Center distance [mm]:	85
8 030 45 268	Radial drilling and milling head ER 25 AX UT	
	Weight [kg]:	5.990
	Notation:	180° reversible
	Tool drive:	Flat (~DIN 1809)
	Shank size [mm]:	45.00
	Shank type:	BMT
	Tool adaption:	ER 25 A - u-tec
	Gear ratio [i]:	1:3
	Torque max [Nm]:	12
	Rotation max [1/min]:	18000
	Rotating direction:	same
	Coolant:	EXT
	Please note:	stronger bearing
	Center distance [mm]:	85

SPINNER

TTS 65 - BMT 45

Part-#	Name
--------	------

8 030 45 269 Radial drilling and milling head ER 25 AX UT IC

Weight [kg]: 6.100
 Notation: 180° reversible
 Tool drive: Flat (~DIN 1809)
 Shank size [mm]: 45.00
 Shank type: BMT
 Tool adaption: ER 25 A - u-tec
 Gear ratio [i]: 1:3
 Torque max [Nm]: 12
 Rotation max [1/min]: 18000
 Rotating direction: same
 Coolant: IC/Ext
 Pressure max [bar]: 140
 Please note: stronger bearing
 Center distance [mm]: 85

8 030 45 274 Radial drilling and milling head C 3 IC

Notation: 180° reversible
 Tool drive: Flat (~DIN 1809)
 Shank size [mm]: 45.00
 Shank type: BMT
 Tool adaption: heimatec Capto(TM) C 3
 Gear ratio [i]: 1:1
 Torque max [Nm]: 25
 Rotation max [1/min]: 8000
 Rotating direction: opposite
 Coolant: IC/Ext
 Pressure max [bar]: 140
 Please note: Check applicability; note tool length!
 Center distance [mm]: 85

8 030 45 570 Radial drilling and milling head ER 25 AX UT

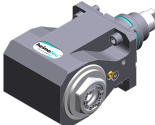

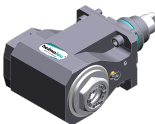

Weight [kg]: 6.010
 Notation: 180° reversible
 Tool drive: Flat (~DIN 1809)
 Shank size [mm]: 45.00
 Shank type: BMT
 Tool adaption: ER 25 A - u-tec
 Gear ratio [i]: 1:1
 Torque max [Nm]: 50
 Rotation max [1/min]: 12000
 Rotating direction: opposite
 Coolant: EXT
 Center distance [mm]: 85

8 030 45 571 Radial drilling and milling head ER 25 AX UT IC

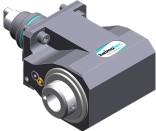

Weight [kg]: 6.400
 Notation: 180° reversible
 Tool drive: Flat (~DIN 1809)
 Shank size [mm]: 45.00
 Shank type: BMT
 Tool adaption: ER 25 A - u-tec
 Gear ratio [i]: 1:1
 Torque max [Nm]: 50
 Rotation max [1/min]: 12000
 Rotating direction: opposite
 Coolant: IC/Ext

Part-#	Name	
	Pressure max [bar]:	140
	Center distance [mm]:	85
8 030 46 413	Angle-mill- and drill holder HT 4	
	Weight [kg]:	6.400
	Notation:	180° reversible
	Tool drive:	Flat (~DIN 1809)
	Shank size [mm]:	45.00
	Shank type:	BMT
	Tool adaption:	HT 4
	Gear ratio [i]:	1:1
	Torque max [Nm]:	50
	Rotation max [1/min]:	6000
	Rotating direction:	opposite
	Coolant:	EXT
	Please note:	Combi bearing
	Center distance [mm]:	85
8 030 46 414	Angle-mill- and drill holder HT 4 IC	
	Weight [kg]:	6.900
	Notation:	180° reversible
	Tool drive:	Flat (~DIN 1809)
	Shank size [mm]:	45.00
	Shank type:	BMT
	Tool adaption:	HT 4
	Gear ratio [i]:	1:1
	Torque max [Nm]:	50
	Rotation max [1/min]:	6000
	Rotating direction:	opposite
	Coolant:	IC/Ext
	Pressure max [bar]:	140
	Please note:	Combi bearing
	Center distance [mm]:	85
8 030 46 415	Radial drilling and milling head HT 4	
	Weight [kg]:	5.810
	Notation:	180° reversible
	Tool drive:	Flat (~DIN 1809)
	Shank size [mm]:	45.00
	Shank type:	BMT
	Tool adaption:	HT 4
	Gear ratio [i]:	2:1
	Torque max [Nm]:	63
	Rotation max [1/min]:	3000
	Rotating direction:	opposite
	Coolant:	EXT
	Please note:	Combi bearing
	Center distance [mm]:	85
8 030 46 416	Radial drilling and milling head HT 4 IC	
	Notation:	180° reversible
	Tool drive:	Flat (~DIN 1809)
	Shank size [mm]:	45.00
	Shank type:	BMT
	Tool adaption:	HT 4
	Gear ratio [i]:	2:1
	Torque max [Nm]:	63



SPINNER

TTS 65 - BMT 45

Part-#	Name	
	Rotation max [1/min]:	3000
	Rotating direction:	opposite
	Coolant:	IC/Ext
	Pressure max [bar]:	140
	Please note:	Combi bearing
	Center distance [mm]:	85
8 030 46 418	Radial drilling and milling head HT 4 IC	
	Notation:	180° reversible
	Tool drive:	Flat (~DIN 1809)
	Shank size [mm]:	45.00
	Shank type:	BMT
	Tool adaption:	HT 4
	Gear ratio [i]:	1:2
	Torque max [Nm]:	16
	Rotation max [1/min]:	12000
	Rotating direction:	same
	Coolant:	IC/Ext
	Pressure max [bar]:	140
	Please note:	stronger bearing
	Center distance [mm]:	85
8 030 46 419	Radial drilling and milling head HT 4	
	Notation:	180° reversible
	Tool drive:	Flat (~DIN 1809)
	Shank size [mm]:	45.00
	Shank type:	BMT
	Tool adaption:	HT 4
	Gear ratio [i]:	1:3
	Torque max [Nm]:	12
	Rotation max [1/min]:	18000
	Rotating direction:	same
	Coolant:	EXT
	Please note:	stronger bearing
	Center distance [mm]:	85
8 030 46 420	Radial drilling and milling head HT 4 IC	
	Notation:	180° reversible
	Tool drive:	Flat (~DIN 1809)
	Shank size [mm]:	45.00
	Shank type:	BMT
	Tool adaption:	HT 4
	Gear ratio [i]:	1:3
	Torque max [Nm]:	12
	Rotation max [1/min]:	18000
	Rotating direction:	same
	Coolant:	IC/Ext
	Pressure max [bar]:	140
	Please note:	stronger bearing
	Center distance [mm]:	85

SPINNER

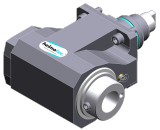
TTS 65 - BMT 45

Part-#	Name	
8 030 46 560	Radial drilling and milling head HT 4	
	Weight [kg]:	6.120
	Notation:	180° reversible
	Tool drive:	Flat (~DIN 1809)
	Shank size [mm]:	45.00
	Shank type:	BMT
	Tool adaption:	HT 4
	Gear ratio [i]:	1:1
	Torque max [Nm]:	50
	Rotation max [1/min]:	12000
	Rotating direction:	opposite
	Coolant:	EXT
	Center distance [mm]:	85
8 030 46 565	Radial drilling and milling head HT 4 IC	
	Weight [kg]:	6.520
	Notation:	180° reversible
	Tool drive:	Flat (~DIN 1809)
	Shank size [mm]:	45.00
	Shank type:	BMT
	Tool adaption:	HT 4
	Gear ratio [i]:	1:1
	Torque max [Nm]:	50
	Rotation max [1/min]:	12000
	Rotating direction:	opposite
	Coolant:	IC/Ext
	Pressure max [bar]:	140
	Center distance [mm]:	85
8 030 47 168	Angle-mill- and drill holder HT 5 IC	
	Notation:	180° reversible
	Tool drive:	Flat (~DIN 1809)
	Shank size [mm]:	45.00
	Shank type:	BMT
	Tool adaption:	HT 5
	Gear ratio [i]:	1:1
	Torque max [Nm]:	50
	Rotation max [1/min]:	6000
	Rotating direction:	opposite
	Coolant:	IC/Ext
	Pressure max [bar]:	140
	Please note:	Combi bearing
	Center distance [mm]:	85
8 031 44 040	Radial milling head universal arbor 16	
	Notation:	180° reversible
	Tool drive:	Flat (~DIN 1809)
	Shank size [mm]:	45.00
	Shank type:	BMT
	Tool adaption:	Universal arbor 16
	Gear ratio [i]:	1:1
	Torque max [Nm]:	50
	Rotation max [1/min]:	6000
	Rotating direction:	opposite
	Coolant:	EXT
	Please note:	Combi bearing
	Center distance [mm]:	85

SPINNER

TTS 65 - BMT 45

Part-#	Name	
8 031 45 049	Radial milling head universal arbor 22	
	Notation:	180° reversible
	Tool drive:	Flat (~DIN 1809)
	Shank size [mm]:	45.00
	Shank type:	BMT
	Tool adaption:	Universal arbor 22
	Gear ratio [i]:	1:1
	Torque max [Nm]:	50
	Rotation max [1/min]:	6000
	Rotating direction:	opposite
	Coolant:	EXT
	Please note:	Combi bearing
	Center distance [mm]:	85
8 033 45 048	Radial drilling and milling head ER 25 AX UT	
	Weight [kg]:	8.360
	Notation:	offset
	Employment for:	Sub spindle
	Tool drive:	Flat (~DIN 1809)
	Shank size [mm]:	45.00
	Shank type:	BMT
	Tool adaption:	ER 25 A - u-tec
	Gear ratio [i]:	1:1
	Torque max [Nm]:	50
	Rotation max [1/min]:	6000
	Rotating direction:	same
	Coolant:	EXT
	Please note:	Combi bearing
	Center distance [mm]:	85
8 033 45 049	Radial drilling and milling head ER 25 AX UT IC	
	Weight [kg]:	8.790
	Notation:	offset
	Employment for:	Sub spindle
	Tool drive:	Flat (~DIN 1809)
	Shank size [mm]:	45.00
	Shank type:	BMT
	Tool adaption:	ER 25 A - u-tec
	Gear ratio [i]:	1:1
	Torque max [Nm]:	50
	Rotation max [1/min]:	6000
	Rotating direction:	same
	Coolant:	IC/Ext
	Pressure max [bar]:	140
	Please note:	Combi bearing
	Center distance [mm]:	85
8 033 46 149	Radial drilling and milling head HT 4	
	Weight [kg]:	8.500
	Notation:	offset
	Employment for:	Sub spindle
	Tool drive:	Flat (~DIN 1809)
	Shank size [mm]:	45.00
	Shank type:	BMT
	Tool adaption:	HT 4
	Gear ratio [i]:	1:1
	Torque max [Nm]:	50
	Rotation max [1/min]:	6000

SPINNER

TTS 65 - BMT 45

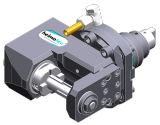
Part-#	Name	
	Rotating direction:	same
	Coolant:	EXT
	Please note:	Combi bearing
	Center distance [mm]:	85
8 033 46 150	Radial drilling and milling head HT 4 IC	
	Weight [kg]:	8.750
	Notation:	offset
	Employment for:	Sub spindle
	Tool drive:	Flat (~DIN 1809)
	Shank size [mm]:	45.00
	Shank type:	BMT
	Tool adaption:	HT 4
	Gear ratio [i]:	1:1
	Torque max [Nm]:	50
	Rotation max [1/min]:	6000
	Rotating direction:	same
	Coolant:	IC/Ext
	Pressure max [bar]:	140
	Please note:	Combi bearing
	Center distance [mm]:	85
8 034 44 000	Radial milling head screw-in milling cutter IC	
	Weight [kg]:	8.730
	Notation:	offset
	Employment for:	Sub spindle
	Tool drive:	Flat (~DIN 1809)
	Shank size [mm]:	45.00
	Shank type:	BMT
	Tool adaption:	Screw-in milling cutter M 12
	Gear ratio [i]:	1:1
	Torque max [Nm]:	50
	Rotation max [1/min]:	8000
	Rotating direction:	same
	Coolant:	IC/Ext
	Pressure max [bar]:	140
	Please note:	Combi bearing
	Center distance [mm]:	85
8 037 44 022	Radial disk mill head arbor 16	
	Weight [kg]:	4.520
	Notation:	180° reversible
	Version:	± 23° turnable
	Tool drive:	Flat (~DIN 1809)
	Shank size [mm]:	45.00
	Shank type:	BMT
	Tool adaption:	Arbor 16
	Gear ratio [i]:	2:1
	Torque max [Nm]:	32
	Rotation max [1/min]:	4000
	Rotating direction:	opposite
	Coolant:	EXT
	Center distance [mm]:	78

SPINNER

TTS 65 - BMT 45

Part-#	Name
--------	------

8 039 44 085 Radial milling head screw-in milling cutter

Weight [kg]: 6.470
 Notation: 84° angle
 Tool drive: Flat (~DIN 1809)
 Shank size [mm]: 45.00
 Shank type: BMT
 Tool adaption: Screw-in milling cutter M 12
 Gear ratio [i]: 1:1
 Torque max [Nm]: 25
 Rotation max [1/min]: 8000
 Rotating direction: opposite
 Coolant: EXT
 Please note: stronger bearing; innenliegender nut;
 Center distance [mm]: 70

8 039 45 089 Radial drilling and milling head ER 25 AX UT

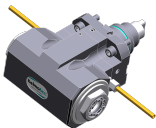

Weight [kg]: 6.000
 Employment for: Main- and sub spindle
 Version: double spindle
 Tool drive: Flat (~DIN 1809)
 Shank size [mm]: 45.00
 Shank type: BMT
 Tool adaption: ER 25 A - u-tec
 Gear ratio [i]: 1:1
 Torque max [Nm]: 50
 Rotation max [1/min]: 12000
 Rotating direction: same/opposite
 Coolant: EXT
 Please note: stronger bearing
 Center distance [mm]: 85

8 039 45 090 Radial drilling and milling head ER 25 AX UT

Weight [kg]: 8.870
 Notation: offset
 Version: double spindle
 Tool drive: Flat (~DIN 1809)
 Shank size [mm]: 45.00
 Shank type: BMT
 Tool adaption: ER 25 A - u-tec
 Gear ratio [i]: 1:1
 Torque max [Nm]: 50
 Rotation max [1/min]: 8000
 Rotating direction: same/opposite
 Coolant: EXT
 Please note: stronger bearing
 Center distance [mm]: 85

8 039 45 104 Radial drilling and milling head ER 25 AX UT IC

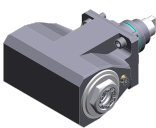

Employment for: Main- and sub spindle
 Version: double spindle
 Tool drive: Flat (~DIN 1809)
 Shank size [mm]: 45.00
 Shank type: BMT
 Tool adaption: ER 25 A - u-tec
 Gear ratio [i]: 1:1
 Torque max [Nm]: 50
 Rotation max [1/min]: 6000



SPINNER

TTS 65 - BMT 45

Part-#	Name	
	Rotating direction:	same/opposite
	Coolant:	IC/Ext
	Pressure max [bar]:	25
	Please note:	Check applicability; note tool length!;
	Center distance [mm]:	85
8 039 45 112	Radial drilling and milling head ER 25 AX UT	
	Weight [kg]:	6.460
	Notation:	84° angle
	Tool drive:	Flat (~DIN 1809)
	Shank size [mm]:	45.00
	Shank type:	BMT
	Tool adaption:	ER 25 A - u-tec
	Gear ratio [i]:	1:1
	Torque max [Nm]:	25
	Rotation max [1/min]:	8000
	Rotating direction:	opposite
	Coolant:	EXT
	Please note:	stronger bearing
	Center distance [mm]:	70
8 039 45 128	Radial drilling and milling head C 3	
	Weight [kg]:	8.930
	Notation:	180° reversible
	Employment for:	Main- and sub spindle
	Version:	double spindle
	Tool drive:	Flat (~DIN 1809)
	Shank size [mm]:	45.00
	Shank type:	BMT
	Tool adaption:	heimatec Capto(TM) C 3
	Gear ratio [i]:	1:1
	Torque max [Nm]:	25
	Rotation max [1/min]:	8000
	Rotating direction:	same/opposite
	Coolant:	EXT
	Please note:	Check applicability; note tool length!
	Center distance [mm]:	85
8 039 46 063	Radial drilling and milling head HT 4	
	Employment for:	Main- and sub spindle
	Version:	double spindle
	Tool drive:	Flat (~DIN 1809)
	Shank size [mm]:	45.00
	Shank type:	BMT
	Tool adaption:	HT 4
	Gear ratio [i]:	1:1
	Torque max [Nm]:	50
	Rotation max [1/min]:	12000
	Rotating direction:	same/opposite
	Coolant:	EXT
	Please note:	stronger bearing
	Center distance [mm]:	85



SPINNER

TTS 65 - BMT 45

Part-#	Name	
8 043 44 032	Universal head +135°/-30° adj. ER16 AX UT	
	Weight [kg]:	8.710
	Notation:	offset; 180° reversible
	Tool drive:	Flat (~DIN 1809)
	Shank size [mm]:	45.00
	Shank type:	BMT
	Tool adaption:	ER 16 A - u-tec
	Gear ratio [i]:	1:1
	Torque max [Nm]:	25
	Rotation max [1/min]:	8000
	Rotating direction:	opposite
	Coolant:	EXT
	Center distance [mm]:	69
	Offset [mm]:	60
8 043 44 033	Universal head +135°/-30° adj. ER16AX UTIK	
	Weight [kg]:	8.720
	Notation:	offset; 180° reversible
	Tool drive:	Flat (~DIN 1809)
	Shank size [mm]:	45.00
	Shank type:	BMT
	Tool adaption:	ER 16 A - u-tec
	Gear ratio [i]:	1:1
	Torque max [Nm]:	25
	Rotation max [1/min]:	8000
	Rotating direction:	opposite
	Coolant:	IC/Ext
	Pressure max [bar]:	140
	Center distance [mm]:	69
	Offset [mm]:	60
8 043 44 034	Universal head +135°/-30° adj. ER16 AX UT	
	Weight [kg]:	8.580
	Notation:	offset; 180° reversible
	Tool drive:	Flat (~DIN 1809)
	Shank size [mm]:	45.00
	Shank type:	BMT
	Tool adaption:	ER 16 A - u-tec
	Gear ratio [i]:	1:2
	Torque max [Nm]:	12
	Rotation max [1/min]:	12000
	Rotating direction:	opposite
	Coolant:	EXT
	Center distance [mm]:	69
	Offset [mm]:	60
8 043 44 035	Universal head +135°/-30° adj. ER16AX UTIK	
	Weight [kg]:	8.670
	Notation:	offset; 180° reversible
	Tool drive:	Flat (~DIN 1809)
	Shank size [mm]:	45.00
	Shank type:	BMT
	Tool adaption:	ER 16 A - u-tec
	Gear ratio [i]:	1:2
	Torque max [Nm]:	12
	Rotation max [1/min]:	12000
	Rotating direction:	opposite

SPINNER

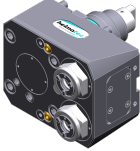
TTS 65 - BMT 45

Part-#	Name	
	Coolant:	IC/Ext
	Pressure max [bar]:	140
	Center distance [mm]:	69
	Offset [mm]:	60
8 050 44 031	Multispindle drilling head ER 16 AX UT	
	Weight [kg]:	4.975
	Notation:	offset
	Employment for:	Main spindle
	Version:	2-spindles
	Tool drive:	Flat (~DIN 1809)
	Shank size [mm]:	45.00
	Shank type:	BMT
	Tool adaption:	ER 16 A - u-tec
	Gear ratio [i]:	1:1
	Torque max [Nm]:	25
	Rotation max [1/min]:	6000
	Rotating direction:	same
	Coolant:	EXT
	Offset [mm]:	58
8 053 44 028	Multispindle radial head ER16 AX UT IC	
	Weight [kg]:	5.636
	Notation:	180° reversible
	Version:	2-spindles
	Tool drive:	Flat (~DIN 1809)
	Shank size [mm]:	45.00
	Shank type:	BMT
	Tool adaption:	ER 16 A - u-tec
	Gear ratio [i]:	1:1
	Torque max [Nm]:	25
	Rotation max [1/min]:	6000
	Rotating direction:	same
	Coolant:	IC/Ext
	Pressure max [bar]:	25
	Center distance [mm]:	85
8 200 99 000	Cover plate 75,0x 75,0x 5,0	
	Weight [kg]:	0.480
	Shank size [mm]:	45.00
	Shank type:	BMT
8 202 00 011	Basic holder longitudinal seat FN 12	
	Weight [kg]:	0.700
	Notation:	180° reversible
	Shank type:	BMT
	Machine adaption:	Centering key b 15
	Tool adaption:	Interface FN 12
	Coolant:	EXT
	Center distance [mm]:	15

SPINNER

TTS 65 - BMT 45

Part-#	Name	
8 209 02 003	Adapter for VDI 30	
	Weight [kg]:	4.050
	Notation:	180° reversible
	Shank type:	BMT
	Machine adaption:	Centering key b 15
	Tool adaption:	DIN 69880 - 30
	Coolant:	EXT
	Center distance [mm]:	85
8 224 01 018	Turning holder sq. 20 IC	
	Weight [kg]:	2.600
	Notation:	180° reversible
	Employment for:	right cutting tools
	Shank type:	BMT
	Machine adaption:	Centering key b 15
	Tool adaption:	Sq. 20
	Coolant:	IC
8 224 02 009	Turning holder sq. 25 IC	
	Weight [kg]:	2.820
	Notation:	180° reversible
	Employment for:	right cutting tools
	Shank type:	BMT
	Machine adaption:	Centering key b 15
	Tool adaption:	Sq. 25
	Coolant:	IC
8 224 03 015	Universal turning holder sq. 3/4" IC	
	Weight [kg]:	2.640
	Notation:	180° reversible
	Shank type:	BMT
	Machine adaption:	Centering key b 15
	Tool adaption:	Sq. 3/4" (19,05mm)
		Sq. 3/4" (19,05mm)
	Coolant:	IC/Ext
	Pressure max [bar]:	100
	Please note:	Key rail
8 224 04 023	Universal turning holder sq. 3/4"	
	Weight [kg]:	2.620
	Notation:	180° reversible
	Shank type:	BMT
	Machine adaption:	Centering key b 15
	Tool adaption:	Sq. 3/4" (19,05mm)
	Coolant:	EXT
8 224 04 061	Universal turning holder sq. 20 IC	
	Weight [kg]:	2.610
	Notation:	180° reversible
	Shank type:	BMT
	Machine adaption:	Centering key b 15
	Tool adaption:	Sq. 20
		Sq. 20
	Coolant:	IC/Ext
	Pressure max [bar]:	100
	Please note:	Key rail



SPINNER

TTS 65 - BMT 45

Part-#	Name	
8 224 04 063	Universal turning holder sq. 20 IC	
	Weight [kg]:	2.050
	Shank type:	BMT
	Machine adaption:	Centering key b 15
	Tool adaption:	Sq. 20
		Sq. 20
	Coolant:	IC/Ext
	Pressure max [bar]:	100
	Please note:	Check applicability! key rail
8 224 05 011	Universal turning holder sq. 25	
	Weight [kg]:	3.050
	Notation:	180° reversible
	Shank type:	BMT
	Machine adaption:	Centering key b 15
	Tool adaption:	Sq. 25
	Coolant:	EXT
8 224 05 030	Universal turning holder sq. 25 IC	
	Weight [kg]:	3.030
	Notation:	180° reversible
	Shank type:	BMT
	Machine adaption:	Centering key b 15
	Tool adaption:	Sq. 25
	Coolant:	IC/Ext
	Pressure max [bar]:	100
	Please note:	Key rail
8 225 01 002	Turning holder sq. 20 IC	
	Weight [kg]:	2.600
	Notation:	180° reversible
	Employment for:	left cutting tools
	Shank type:	BMT
	Machine adaption:	Centering key b 15
	Tool adaption:	Sq. 20
	Coolant:	IC
8 225 02 000	Turning holder sq. 25 IC	
	Weight [kg]:	2.800
	Notation:	180° reversible
	Employment for:	left cutting tools
	Shank type:	BMT
	Machine adaption:	Centering key b 15
	Tool adaption:	Sq. 25
	Coolant:	IC
8 229 05 007	Tool holder C 3 IC	
	Weight [kg]:	2.700
	Notation:	180° reversible
	Version:	right
	Shank type:	BMT
	Machine adaption:	Centering key b 15
	Tool adaption:	heimatec Capto(TM) C 3
	Coolant:	IC
	Please note:	Check applicability; note tool length!
	Offset [mm]:	64

SPINNER

TTS 65 - BMT 45

Part-#	Name	
8 240 05 006	Collet chuck holder ER 25	
	Weight [kg]:	3.090
	Notation:	180° reversible
	Shank type:	BMT
	Machine adaption:	Centering key b 15
	Tool adaption:	ER 25
	Coolant:	IC/Ext
	Pressure max [bar]:	80
	Center distance [mm]:	85
8 240 05 038	Collet chuck holder ER 25 AX UT	
	Weight [kg]:	3.090
	Notation:	180° reversible
	Shank type:	BMT
	Machine adaption:	Centering key b 15
	Tool adaption:	ER 25 A - u-tec
	Coolant:	IC/Ext
	Center distance [mm]:	85
8 240 05 058	Tool holder ABS 50 IC/Ext	
	Weight [kg]:	4.340
	Notation:	offset
	Shank type:	BMT
	Machine adaption:	Centering key b 15
	Tool adaption:	ABS 50
	Coolant:	IC/Ext
	Center distance [mm]:	85
8 240 05 064	Boring bar holder Ø 16	
	Notation:	180° reversible
	Shank type:	BMT
	Machine adaption:	Centering key b 15
	Tool adaption:	Ø 16
	Coolant:	IC/Ext
	Center distance [mm]:	85
8 240 06 013	Collet chuck holder ER 32	
	Weight [kg]:	3.220
	Notation:	180° reversible
	Shank type:	BMT
	Machine adaption:	Centering key b 15
	Tool adaption:	ER 32
	Coolant:	IC/Ext
	Pressure max [bar]:	80
	Center distance [mm]:	85
8 240 06 014	Tool holder HT 4 IC	
	Weight [kg]:	3.070
	Notation:	180° reversible
	Shank type:	BMT
	Machine adaption:	Centering key b 15
	Tool adaption:	HT 4
	Coolant:	IC/Ext
	Center distance [mm]:	85

SPINNER

TTS 65 - BMT 45

Part-#	Name	
8 240 06 048	Tool holder C 4 IC	
	Weight [kg]:	4.640
	Notation:	180° reversible
	Version:	offset
	Shank type:	BMT
	Machine adaption:	Centering key b 15
	Tool adaption:	heimatec Capto(TM) C 4
	Coolant:	IC
	Center distance [mm]:	85
8 240 06 055	Boring bar holder Ø 20	
	Weight [kg]:	4.180
	Notation:	180° reversible
	Shank type:	BMT
	Machine adaption:	Centering key b 15
	Tool adaption:	Ø 20
	Coolant:	IC/Ext
	Center distance [mm]:	85
8 240 07 015	Boring bar holder Ø 1 1/4"	
	Weight [kg]:	3.750
	Notation:	180° reversible
	Shank type:	BMT
	Machine adaption:	Centering key b 15
	Tool adaption:	Ø 1 1/4" (31,75mm)
	Coolant:	IC/Ext
	Center distance [mm]:	85
8 240 07 018	Boring bar holder Ø 25	
	Weight [kg]:	4.000
	Notation:	180° reversible
	Shank type:	BMT
	Machine adaption:	Centering key b 15
	Tool adaption:	Ø 25
	Coolant:	IC/Ext
	Center distance [mm]:	85
8 240 07 019	Boring bar holder Ø 1"	
	Notation:	180° reversible
	Shank type:	BMT
	Machine adaption:	Centering key b 15
	Tool adaption:	Ø 1" (25,4mm)
	Coolant:	IC/Ext
	Center distance [mm]:	85
8 240 07 020	Boring bar holder Ø 25	
	Weight [kg]:	4.450
	Notation:	180° reversible
	Shank type:	BMT
	Machine adaption:	Centering key b 15
	Tool adaption:	Ø 25
	Coolant:	IC/Ext
	Center distance [mm]:	100

SPINNER

TTS 65 - BMT 45

Part-#	Name	
8 240 07 042	Tool holder HT 5 IC	
	Weight [kg]:	3.100
	Notation:	180° reversible
	Shank type:	BMT
	Machine adaption:	Centering key b 15
	Tool adaption:	HT 5
	Coolant:	IC/Ext
	Center distance [mm]:	85
8 240 08 021	Boring bar holder Ø 32	
	Weight [kg]:	3.780
	Notation:	180° reversible
	Shank type:	BMT
	Machine adaption:	Centering key b 15
	Tool adaption:	Ø 32
	Coolant:	IC/Ext
	Pressure max [bar]:	80
	Center distance [mm]:	85
8 240 08 022	Boring bar holder Ø 1 1/2"	
	Notation:	180° reversible
	Shank type:	BMT
	Machine adaption:	Centering key b 15
	Tool adaption:	Ø 1 1/2" (38,1mm)
	Coolant:	IC/Ext
	Center distance [mm]:	85
8 240 08 023	Boring bar holder Ø 32	
	Weight [kg]:	4.310
	Notation:	180° reversible
	Shank type:	BMT
	Machine adaption:	Centering key b 15
	Tool adaption:	Ø 32
	Coolant:	IC/Ext
	Center distance [mm]:	100
8 240 08 047	Boring bar holder Ø 32	
	Weight [kg]:	4.020
	Notation:	180° reversible
	Version:	offset
	Shank type:	BMT
	Machine adaption:	Centering key b 15
	Tool adaption:	Ø 32
	Coolant:	IC/Ext
	Pressure max [bar]:	80
	Center distance [mm]:	85
8 240 08 057	Boring bar holder Ø 32	
	Weight [kg]:	3.890
	Notation:	180° reversible
	Version:	offset
	Shank type:	BMT
	Machine adaption:	Centering key b 15
	Tool adaption:	Ø 32
	Coolant:	IC/Ext
	Pressure max [bar]:	80
	Center distance [mm]:	85

SPINNER

TTS 65 - BMT 45

Part-#	Name	
	8 240 09 017	Boring bar holder Ø 40
	Weight [kg]:	3.600
	Notation:	180° reversible
	Shank type:	BMT
	Machine adaption:	Centering key b 15
	Tool adaption:	Ø 40
	Coolant:	IC/Ext
Center distance [mm]:	85	
	8 240 09 018	Boring bar holder Ø 40
	Weight [kg]:	4.000
	Notation:	180° reversible
	Shank type:	BMT
	Machine adaption:	Centering key b 15
	Tool adaption:	Ø 40
	Coolant:	IC/Ext
Center distance [mm]:	100	
	8 240 09 059	Boring bar holder Ø 50
	Weight [kg]:	3.160
	Notation:	180° reversible
	Shank type:	BMT
	Machine adaption:	Centering key b 15
	Tool adaption:	Ø 50
	Coolant:	EXT
Center distance [mm]:	65	
	8 244 04 000	Combi facing holder sq. 20
	Weight [kg]:	3.930
	Employment for:	Main- and sub spindle
	Shank type:	BMT
	Machine adaption:	Centering key b 15
	Tool adaption:	Sq. 20
	Coolant:	EXT
Pressure max [bar]:	80	
	8 244 04 007	Combi facing holder sq. 3/4"
	Employment for:	Main- and sub spindle
	Shank type:	BMT
	Machine adaption:	Centering key b 15
	Tool adaption:	Sq. 3/4" (19,05mm)
	Coolant:	EXT
	8 244 04 029	Combi facing holder sq. 20 IC
	Employment for:	Main- and sub spindle
	Shank type:	BMT
	Machine adaption:	Centering key b 15
	Tool adaption:	Sq. 20
	Coolant:	IC/Ext
	Pressure max [bar]:	100

SPINNER

TTS 65 - BMT 45

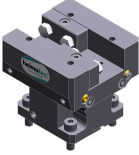
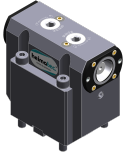
Part-#	Name	
8 244 05 009	Combi facing holder sq. 25	Weight [kg]: 4.320
		Employment for: Main- and sub spindle
		Special
		BMT
		Centering key b 15
		Sq. 25
		EXT
8 249 05 000	Double collet chuck holder ER 25	Weight [kg]: 3.370
		Notation: 180° reversible
		Employment for: Main- and sub spindle
		BMT
		Centering key b 15
		ER 25
		ER 25
		IC/Ext
		Coolant: IC/Ext
		Pressure max [bar]: 80
		Center distance [mm]: 85
8 249 05 007	Double collet chuck holder ER 25 AX UT	Weight [kg]: 3.370
		Notation: 180° reversible
		Employment for: Main- and sub spindle
		BMT
		Centering key b 15
		ER 25 A - u-tec
		ER 25 A - u-tec
		IC/Ext
		Coolant: IC/Ext
		Center distance [mm]: 85
8 249 05 009	Double tool holder C 3 IC	Weight [kg]: 5.050
		Employment for: Main- and sub spindle
		right
		BMT
		Centering key b 15
		heimatec Capto(TM) C 3
		heimatec Capto(TM) C 3
		IC
		Coolant: IC
		Please note: Check applicability; note tool length!
		Center distance [mm]: 85
8 249 06 002	Double collet chuck holder ER 32	Weight [kg]: 3.590
		Notation: 180° reversible
		Employment for: Main- and sub spindle
		BMT
		Centering key b 15
		ER 32
		ER 32
		IC/Ext
		Coolant: IC/Ext
		Pressure max [bar]: 80
		Center distance [mm]: 85



SPINNER

TTS 65 - BMT 45

Part-#	Name	
8 249 06 003	Double tool holder HT 4	
	Weight [kg]:	3.300
	Notation:	180° reversible
	Employment for:	Main- and sub spindle
	Shank type:	BMT
	Machine adaption:	Centering key b 15
	Tool adaption:	HT 4
		HT 4
	Coolant:	IC/Ext
	Center distance [mm]:	85
8 249 07 001	Double boring bar holder Ø 1 1/4"	
	Weight [kg]:	3.730
	Notation:	180° reversible
	Employment for:	Main- and sub spindle
	Shank type:	BMT
	Machine adaption:	Centering key b 15
	Tool adaption:	Ø 1 1/4" (31,75mm)
	Coolant:	IC/Ext
	Center distance [mm]:	85
8 249 07 004	Double boring bar holder Ø 25	
	Weight [kg]:	3.690
	Notation:	180° reversible
	Employment for:	Main- and sub spindle
	Shank type:	BMT
	Machine adaption:	Centering key b 15
	Tool adaption:	Ø 25
	Coolant:	IC/Ext
	Center distance [mm]:	85
8 249 07 008	Double boring bar holder Ø 25	
	Notation:	180° reversible
	Employment for:	Main- and sub spindle
	Shank type:	BMT
	Machine adaption:	Centering key b 15
	Tool adaption:	Ø 25
	Coolant:	IC/Ext
	Pressure max [bar]:	100
	Center distance [mm]:	100
8 249 08 004	Double boring bar holder Ø 32	
	Weight [kg]:	3.540
	Notation:	180° reversible
	Employment for:	Main- and sub spindle
	Shank type:	BMT
	Machine adaption:	Centering key b 15
	Tool adaption:	Ø 32
	Coolant:	IC/Ext
	Center distance [mm]:	85

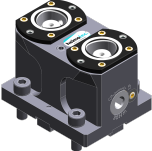

SPINNER

TTS 65 - BMT 45

Part-#	Name	
8 249 08 005	Double boring bar holder Ø 32	
	Notation: Employment for: Shank type: Machine adaption: Tool adaption: Coolant: Pressure max [bar]: Center distance [mm]:	180° reversible Main- and sub spindle BMT Centering key b 15 Ø 32 IC/Ext 100 100
8 250 05 004	Multiple tool holder C 3 IC	
	Weight [kg]: Employment for: Version: Shank type: Machine adaption: Tool adaption: Coolant: Please note: Offset [mm]:	2.100 Main- and sub spindle right BMT Centering key b 15 heimatec Capto(TM) C 3 heimatec Capto(TM) C 3 IC Check applicability; note tool length! 27 27
8 251 04 016	Combi double turning holder sq. 20	
	Weight [kg]: Employment for: Shank type: Machine adaption: Tool adaption: Coolant:	4.980 Main- and sub spindle BMT Centering key b 15 Sq. 20 Sq. 20 Sq. 20 Sq. 20 EXT
8 251 04 017	Combi double turning holder sq. 3/4"	
	Weight [kg]: Employment for: Shank type: Machine adaption: Tool adaption: Coolant:	5.160 Main- and sub spindle BMT Centering key b 15 Sq. 3/4" (19,05mm) Sq. 3/4" (19,05mm) Sq. 3/4" (19,05mm) Sq. 3/4" (19,05mm) EXT
8 251 04 050	Combi double turning holder sq. 20 IC	
	Weight [kg]: Employment for: Shank type: Machine adaption: Tool adaption: Coolant: Pressure max [bar]:	5.100 Main- and sub spindle BMT Centering key b 15 Sq. 20 Sq. 20 Sq. 20 Sq. 20 IC/Ext 100



SPINNER

TTS 65 - BMT 45

Part-#	Name	
	Please note:	Key rail
8 253 05 000	Multiple boring bar holder Ø 3/4"	
	Weight [kg]:	3.320
	Notation:	180° reversible
	Shank type:	BMT
	Machine adaption:	Centering key b 15
	Tool adaption:	Ø 3/4" (19,05mm)
		Ø 3/4" (19,05mm)
	Coolant:	IC/Ext
	Center distance [mm]:	55/90
8 253 05 002	Double boring bar holder Ø 3/4"	
	Weight [kg]:	3.460
	Notation:	180° reversible
	Shank type:	BMT
	Machine adaption:	Centering key b 15
	Tool adaption:	Ø 3/4" (19,05mm)
		Ø 3/4" (19,05mm)
	Coolant:	IC/Ext
	Center distance [mm]:	65/90
8 253 06 004	Double boring bar holder Ø 20	
	Notation:	180° reversible
	Shank type:	BMT
	Machine adaption:	Centering key b 15
	Tool adaption:	Ø 20
		Ø 20
	Coolant:	IC/Ext
	Pressure max [bar]:	80
	Center distance [mm]:	65/90
8 253 07 012	Double boring bar holder Ø 25	
	Weight [kg]:	3.150
	Notation:	180° reversible
	Shank type:	BMT
	Machine adaption:	Centering key b 15
	Tool adaption:	Ø 25
		Ø 25
	Coolant:	IC/Ext
	Pressure max [bar]:	80
	Center distance [mm]:	55/90
8 253 07 013	Double boring bar holder Ø 1"	
	Weight [kg]:	3.070
	Notation:	180° reversible
	Shank type:	BMT
	Machine adaption:	Centering key b 15
	Tool adaption:	Ø 1" (25,4mm)
		Ø 1" (25,4mm)
	Coolant:	IC/Ext
	Center distance [mm]:	55/90

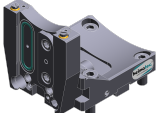

SPINNER

TTS 65 - BMT 45

Part-#	Name	
8 253 07 034	Multiple boring bar holder Ø 25	
	Weight [kg]:	2.330
	Notation:	180° reversible
	Version:	offset
	Shank type:	BMT
	Machine adaption:	Centering key b 15
	Tool adaption:	Ø 25
		Ø 25
	Coolant:	IC/Ext
	Please note:	Use necessarily check; note tool length
	Center distance [mm]:	55/100
8 253 08 010	Multiple boring bar holder Ø 32	
	Weight [kg]:	3.500
	Notation:	180° reversible
	Shank type:	BMT
	Machine adaption:	Centering key b 15
	Tool adaption:	Ø 32
		Ø 32
	Coolant:	IC/Ext
	Please note:	Use prüfen; note tool length!
	Center distance [mm]:	65/100
8 259 01 015	Multiple turning holder 4x sq. 20	
	Weight [kg]:	5.320
	Employment for:	Main- and sub spindle
	Version:	Y-axes offset
	Shank type:	BMT
	Machine adaption:	Centering key b 15
	Tool adaption:	Sq. 20
		Sq. 20
		Sq. 20
		Sq. 20
	Coolant:	EXT
8 259 01 016	Multiple turning holder 4x sq. 20 IC	
	Weight [kg]:	5.300
	Employment for:	Main- and sub spindle
	Version:	Y-axes offset
	Shank type:	BMT
	Machine adaption:	Centering key b 15
	Tool adaption:	Sq. 20
		Sq. 20
		Sq. 20
		Sq. 20
	Coolant:	IC/Ext
	Pressure max [bar]:	100
8 320 02 012	Cut-off holder, height adjustable SH 26 IC	
	Weight [kg]:	1.270
	Notation:	180° reversible
	Shank type:	BMT
	Machine adaption:	Centering key b 15
	Tool adaption:	Clampshaft SH 26
	Coolant:	IC/Ext
	Pressure max [bar]:	70

SPINNER

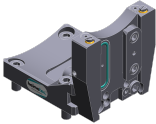
TTS 65 - BMT 45

Part-#	Name	
8 320 02 013	Cut-off holder, height adjustable SH 26 IC	
	Weight [kg]:	1.360
	Notation:	180° reversible
	Shank type:	BMT
	Machine adaption:	Centering key b 15
	Tool adaption:	Clampshaft SH 26
	Coolant:	IC/Ext
	Pressure max [bar]:	70
	Please note:	Clampshaft internal
8 320 03 011	Cut-off holder, height adjustable SH 32 IC	
	Weight [kg]:	1.330
	Notation:	180° reversible
	Shank type:	BMT
	Machine adaption:	Centering key b 15
	Tool adaption:	Clampshaft SH 32
	Coolant:	IC/Ext
	Pressure max [bar]:	70
8 320 03 018	Cut-off holder, height adjustable SH 32 IC	
	Weight [kg]:	1.480
	Notation:	180° reversible
	Shank type:	BMT
	Machine adaption:	Centering key b 15
	Tool adaption:	Clampshaft SH 32
	Coolant:	IC/Ext
	Pressure max [bar]:	70
	Please note:	Clampshaft internal
8 320 03 023	Cut-off holder, height adjustable SH 32 IC	
	Weight [kg]:	1.590
	Shank type:	BMT
	Machine adaption:	Centering key b 15
	Tool adaption:	Clampshaft SH 32
	Coolant:	IC/Ext
	Pressure max [bar]:	70
	Please note:	with offset cut-off tool holder; use
8 320 03 051	Cut-off holder, height adjustable SH 32 IC	
	Weight [kg]:	1.230
	Notation:	180° reversible
	Version:	Clampshaft on turret center
	Shank type:	BMT
	Machine adaption:	Centering key b 15
	Tool adaption:	Clampshaft SH 32
	Coolant:	IC/Ext
	Pressure max [bar]:	70
8 710 94 005	Mounting device BMT 45 Spinner	
	Weight [kg]:	10.040
	Tool adaption:	BMT 45

heimatec.u-tec®

heimatec.com

Products / Tool change systems /
u-tec® Tool-changing system



versions see catalog

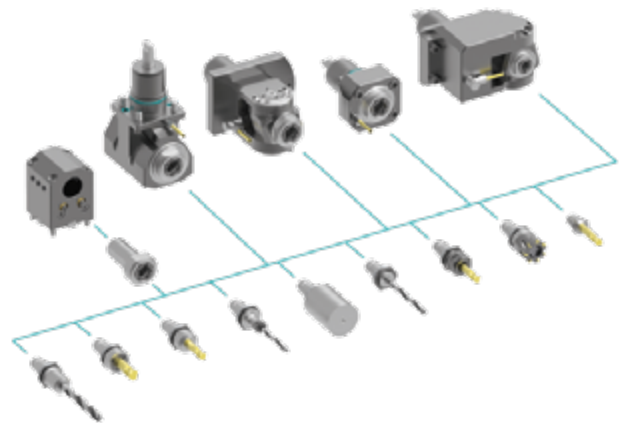

heimatec.easy-quick

heimatec.com

Products / Tool change systems /
easy-quick HT quick-changing system



versions see catalog

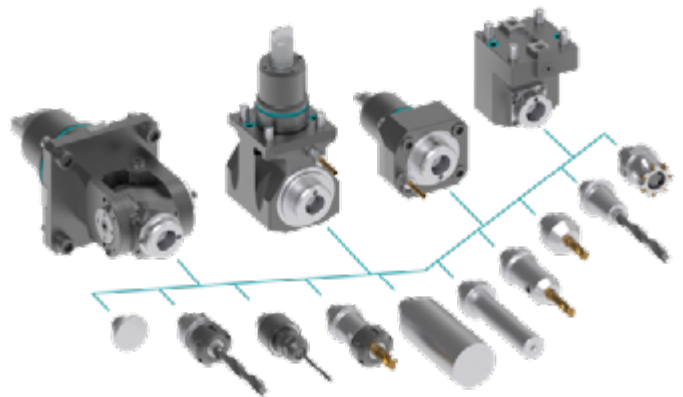

heimatec.Capto™

heimatec.com

Products / Tool change systems /
heimatec.Capto™ quick-changing system



versions see catalog

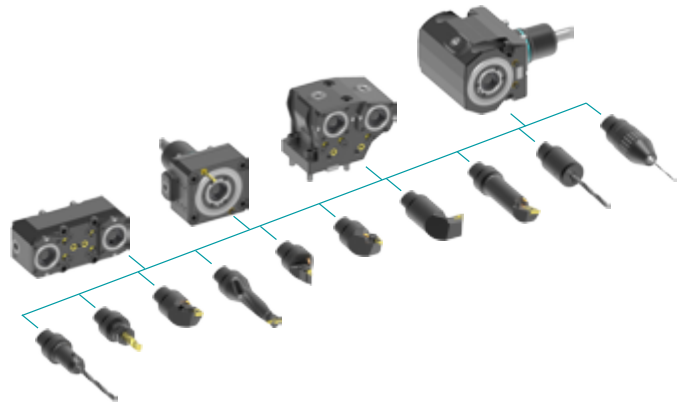

heimatec.accessories

heimatec.com

Products / Accessories



versions see catalog





● heimatec overseas branches

○ global representations of heimatec

heimatec[®]

heimatec GmbH
Präzisionswerkzeuge
Carl-Benz-Str. 4
77871 Renchen
Germany

T +49 7843 9466 0
www.heimatec.com
info@heimatec.com

Please find the contact details of our worldwide trading partners on our website:
<https://heimatec.com/business-partners>