

Emco

EMCOTURN E65
S - VDI 30



High-tech from heimatec - heimatec - Tools and systems for productive turning and milling

heimatec belongs to the international technology and quality leaders for precision tools and specializes in the development and production of high-precision static and live tools for all CNC lathes, CNC turn-/mill machines and CNC machining centers.

The range of products* spans from static BMT and VDI tool holders, live tools up to highly complex customer-specific individual solutions. heimatec, headquartered in Renchen, has a own subsidiary in Asia and India and numerous representatives as well as trading partners all over the world.

*OUR PRODCUTS

Static tool holders

Live tool units

Precision tools

Tools for turning and machining centres

Tools for swiss type lathes

Tool changing and uick-change systems





Tool systems for gear production

Digital tool management

This catalogue, including all its parts, is protected by copyright. Any use outside the restricted limitations of the Copyright Act without the consent of heimatec is inadmissible and liable to prosecution. This applies in particular to duplication, translation, microfilming and storage and processing in electronic systems.

heimatec GmbH reserves the right to make technical changes at any time without giving prior notice. This applies in particular to adjustments at any time to meet new or changed international standards, or in case of further developments of our products or manufacturing processes.

The current version of our General Terms and Conditions can be found on our website.

Part-#	Name	
8 010 25 090	Axial drilling and milling head ER 25	
	Weight [kg]:	1.580
	Tool drive:	DIN 5480
	Shank size [mm]:	30.00
	Shank type:	VDI
	Tool adaption:	ER 25
	Gear ratio [i]:	1:1
	Torque max [Nm]:	25
	Rotation max [1/min]:	6000
	Rotating direction:	same
	Coolant:	EXT
	Please note:	round housing \varnothing 68
8 010 25 091	Axial drilling and milling head ER 25 IC	
	Weight [kg]:	1.830
	Tool drive:	DIN 5480
	Shank size [mm]:	30.00
	Shank type:	VDI
	Tool adaption:	ER 25
	Gear ratio [i]:	1:1
	Torque max [Nm]:	25
	Rotation max [1/min]:	6000
	Rotating direction:	same
	Coolant:	IC/Ext
	Pressure max [bar]:	25
	Please note:	round housing \varnothing 68
8 010 25 118	Axial drilling and milling head ER 25 AX UT	
	Weight [kg]:	1.780
	Tool drive:	DIN 5480
	Shank size [mm]:	30.00
	Shank type:	VDI
	Tool adaption:	ER 25 A - u-tec
	Gear ratio [i]:	1:1
	Torque max [Nm]:	25
	Rotation max [1/min]:	12000
	Rotating direction:	same
	Coolant:	EXT
	Please note:	stronger bearing
8 010 25 119	Axial drilling and milling head ER 25 AX UT IC	
	Weight [kg]:	1.780
	Tool drive:	DIN 5480
	Shank size [mm]:	30.00
	Shank type:	VDI
	Tool adaption:	ER 25 A - u-tec
	Gear ratio [i]:	1:1
	Torque max [Nm]:	25
	Rotation max [1/min]:	6000
	Rotating direction:	same
	Coolant:	IC/Ext
	Pressure max [bar]:	25
	Please note:	round housing \varnothing 68

Part-#	Name	
8 013 22 000	Axial drilling and milling head Weldon 6	
	Version:	left
	Tool drive:	DIN 5480
	Shank size [mm]:	30.00
	Shank type:	VDI
	Tool adaption:	Weldon (DIN 1835 b) 6
	Gear ratio [i]:	1:2
	Torque max [Nm]:	8
	Rotation max [1/min]:	8000
	Rotating direction:	same
	Coolant:	EXT
8 013 24 014	Axial drilling and milling head Weldon 10	
	Version:	left
	Tool drive:	DIN 5480
	Shank size [mm]:	30.00
	Shank type:	VDI
	Tool adaption:	Weldon (DIN 1835 b) 10
	Gear ratio [i]:	1:2
	Torque max [Nm]:	8
	Rotation max [1/min]:	8000
	Rotating direction:	same
	Coolant:	EXT
8 013 25 004	Axial drilling and milling head ER 25	
	Weight [kg]:	4.440
	Version:	left
	Tool drive:	DIN 5480
	Shank size [mm]:	30.00
	Shank type:	VDI
	Tool adaption:	ER 25
	Gear ratio [i]:	2:1
	Torque max [Nm]:	40
	Rotation max [1/min]:	3000
	Rotating direction:	same
	Coolant:	EXT
	Please note:	stronger bearing
8 013 25 007	Axial drilling and milling head Weldon 16	
	Weight [kg]:	4.320
	Version:	left
	Tool drive:	DIN 5480
	Shank size [mm]:	30.00
	Shank type:	VDI
	Tool adaption:	Weldon (DIN 1835 b) 16
	Gear ratio [i]:	1:2
	Torque max [Nm]:	8
	Rotation max [1/min]:	8000
	Rotating direction:	same
	Coolant:	EXT
	Please note:	stronger bearing

Part-#	Name	
8 014 25 002	Axial milling head universal arbor 22	
	Tool drive:	DIN 5480
	Shank size [mm]:	30.00
	Shank type:	VDI
	Tool adaption:	Universal arbor 22
	Gear ratio [i]:	2:1
	Torque max [Nm]:	40
	Rotation max [1/min]:	3000
	Rotating direction:	same
	Coolant:	EXT
	Please note:	stronger bearing
8 019 24 054	Axial milling head universal arbor 16	
	Weight [kg]:	6.550
	Notation:	offset
	Version:	left
	Tool drive:	DIN 5480
	Shank size [mm]:	30.00
	Shank type:	VDI
	Tool adaption:	Universal arbor 16
	Gear ratio [i]:	3:1
	Torque max [Nm]:	75
	Rotation max [1/min]:	3000
	Rotating direction:	opposite
	Coolant:	EXT
	Please note:	Taper roller bearings; check applicability; with
	Offset [mm]:	50
8 030 25 014	Radial drilling and milling head ER 25	
	Weight [kg]:	4.230
	Employment for:	Main spindle
	Version:	left
	Tool drive:	DIN 5480
	Shank size [mm]:	30.00
	Shank type:	VDI
	Tool adaption:	ER 25
	Gear ratio [i]:	1:1
	Torque max [Nm]:	25
	Rotation max [1/min]:	6000
	Rotating direction:	opposite
	Coolant:	EXT
	Please note:	with fixation rail
	Center distance [mm]:	100
8 030 25 025	Radial drilling and milling head Weldon 16 IC	
	Version:	left
	Tool drive:	DIN 5480
	Shank size [mm]:	30.00
	Shank type:	VDI
	Tool adaption:	Weldon (DIN 1835 b) 16
	Gear ratio [i]:	1:1
	Torque max [Nm]:	25
	Rotation max [1/min]:	6000
	Rotating direction:	opposite
	Coolant:	IC/Ext
	Center distance [mm]:	100

Part-#	Name	
8 030 25 114	Radial drilling and milling head ER 25	
	Weight [kg]:	4.860
	Version:	left
	Tool drive:	DIN 5480
	Shank size [mm]:	30.00
	Shank type:	VDI
	Tool adaption:	ER 25
	Gear ratio [i]:	1:1
	Torque max [Nm]:	25
	Rotation max [1/min]:	6000
	Rotating direction:	opposite
	Coolant:	EXT
	Center distance [mm]:	120
8 030 25 132	Radial drilling and milling head ER 25	
	Version:	right
	Tool drive:	DIN 5480
	Shank size [mm]:	30.00
	Shank type:	VDI
	Tool adaption:	ER 25
	Gear ratio [i]:	1:1
	Torque max [Nm]:	25
	Rotation max [1/min]:	6000
	Rotating direction:	opposite
	Coolant:	EXT
	Center distance [mm]:	100
8 030 25 152	Radial drilling and milling head ER 25 IC	
	Version:	left
	Tool drive:	DIN 5480
	Shank size [mm]:	30.00
	Shank type:	VDI
	Tool adaption:	ER 25
	Gear ratio [i]:	1:2
	Torque max [Nm]:	12
	Rotation max [1/min]:	12000
	Rotating direction:	opposite
	Coolant:	IC/Ext
	Pressure max [bar]:	25
	Center distance [mm]:	100
8 030 25 287	Radial drilling and milling head ER 25 AX UT	
	Version:	left
	Tool drive:	DIN 5480
	Shank size [mm]:	30.00
	Shank type:	VDI
	Tool adaption:	ER 25 A - u-tec
	Gear ratio [i]:	1:1
	Torque max [Nm]:	25
	Rotation max [1/min]:	6000
	Rotating direction:	opposite
	Coolant:	EXT
	Center distance [mm]:	120

Part-#	Name	
8 030 25 321	Radial drilling and milling head ER 25 AX UT	
	Weight [kg]:	5.060
	Version:	right
	Tool drive:	DIN 5480
	Shank size [mm]:	30.00
	Shank type:	VDI
	Tool adaption:	ER 25 A - u-tec
	Gear ratio [i]:	1:1
	Torque max [Nm]:	25
	Rotation max [1/min]:	6000
	Rotating direction:	opposite
	Coolant:	EXT
	Center distance [mm]:	120
8 030 25 322	Radial drilling and milling head ER 25	
	Version:	right
	Tool drive:	DIN 5480
	Shank size [mm]:	30.00
	Shank type:	VDI
	Tool adaption:	ER 25
	Gear ratio [i]:	1:1
	Torque max [Nm]:	25
	Rotation max [1/min]:	6000
	Rotating direction:	opposite
	Coolant:	EXT
	Center distance [mm]:	120
8 030 26 004	Radial drilling and milling head Weldon 20	
	Weight [kg]:	4.380
	Version:	left
	Tool drive:	DIN 5480
	Shank size [mm]:	30.00
	Shank type:	VDI
	Tool adaption:	Weldon (DIN 1835 b) 20
	Gear ratio [i]:	1:1
	Torque max [Nm]:	16
	Rotation max [1/min]:	6000
	Rotating direction:	opposite
	Coolant:	EXT
	Please note:	stronger bearing
	Center distance [mm]:	100
8 030 26 044	Radial drilling and milling head HT 4	
	Weight [kg]:	4.060
	Version:	right
	Tool drive:	DIN 5480
	Shank type:	VDI
	Tool adaption:	HT 4
	Gear ratio [i]:	1:1
	Torque max [Nm]:	25
	Rotation max [1/min]:	6000
	Rotating direction:	opposite
	Coolant:	EXT
	Center distance [mm]:	100

Part-#	Name	
8 030 26 046	Radial drilling and milling head HT 4 IC	
	Weight [kg]:	4.380
	Version:	right
	Tool drive:	DIN 5480
	Shank size [mm]:	30.00
	Shank type:	VDI
	Tool adaption:	HT 4
	Gear ratio [i]:	1:1
	Torque max [Nm]:	25
	Rotation max [1/min]:	6000
	Rotating direction:	opposite
	Coolant:	IC/Ext
	Pressure max [bar]:	25
	Center distance [mm]:	100
8 031 23 000	Radial milling head arbor 13	
	Tool drive:	DIN 5480
	Shank size [mm]:	30.00
	Shank type:	VDI
	Tool adaption:	Arbor 13
	Gear ratio [i]:	1:1
	Torque max [Nm]:	16
	Rotation max [1/min]:	6000
	Rotating direction:	opposite
	Coolant:	EXT
8 031 25 005	Radial milling head universal arbor 22	
	Version:	left
	Tool drive:	DIN 5480
	Shank size [mm]:	30.00
	Shank type:	VDI
	Tool adaption:	Universal arbor 22
	Gear ratio [i]:	2:1
	Torque max [Nm]:	32
	Rotation max [1/min]:	3000
	Rotating direction:	opposite
	Coolant:	EXT
8 036 25 001	Radial drilling and milling head ER 25	
	Weight [kg]:	4.200
	Version:	doubletoothed
	Tool drive:	DIN 5480
	Shank size [mm]:	30.00
	Shank type:	VDI
	Tool adaption:	ER 25
	Gear ratio [i]:	1:1
	Torque max [Nm]:	25
	Rotation max [1/min]:	6000
	Rotating direction:	opposite
	Coolant:	EXT
	Please note:	with fixation rail
	Center distance [mm]:	100

Part-#	Name	
8 036 25 032	Radial drilling and milling head ER 25 AX UT IC	
	Weight [kg]:	4.740
	Version:	doubletoothed
	Tool drive:	DIN 5480
	Shank size [mm]:	30.00
	Shank type:	VDI
	Tool adaption:	ER 25 A - u-tec
	Gear ratio [i]:	1:1
	Torque max [Nm]:	25
	Rotation max [1/min]:	6000
	Rotating direction:	opposite
	Coolant:	IC/Ext
	Pressure max [bar]:	140
	Center distance [mm]:	100
8 036 25 060	Radial drilling and milling head ER 25 AX UT	
	Version:	doubletoothed
	Tool drive:	DIN 5480
	Shank size [mm]:	30.00
	Shank type:	VDI
	Tool adaption:	ER 25 A - u-tec
	Gear ratio [i]:	1:1
	Torque max [Nm]:	25
	Rotation max [1/min]:	6000
	Rotating direction:	opposite
	Coolant:	EXT
	Please note:	stronger bearing
	Center distance [mm]:	100
8 036 25 073	Radial drilling and milling head ER 25 IC	
	Weight [kg]:	4.640
	Version:	doubletoothed
	Tool drive:	DIN 5480
	Shank size [mm]:	30.00
	Shank type:	VDI
	Tool adaption:	ER 25
	Gear ratio [i]:	1:1
	Torque max [Nm]:	25
	Rotation max [1/min]:	6000
	Rotating direction:	opposite
	Coolant:	IC/Ext
	Pressure max [bar]:	140
	Please note:	with fixation rail
	Center distance [mm]:	100
8 039 25 012	Radial drilling and milling head ER 25	
	Weight [kg]:	4.730
	Version:	double spindle
	Tool drive:	DIN 5480
	Shank size [mm]:	30.00
	Shank type:	VDI
	Tool adaption:	ER 25
	Gear ratio [i]:	1:1
	Torque max [Nm]:	25
	Rotation max [1/min]:	6000
	Rotating direction:	same/opposite
	Coolant:	EXT
	Please note:	stronger bearing

Part-#	Name	
	Center distance [mm]:	100
8 039 25 077	Radial drilling and milling head ER 25 AX UT	
	Weight [kg]:	6.100
	Version:	double spindle
	Tool drive:	DIN 5480
	Shank size [mm]:	30.00
	Shank type:	VDI
	Tool adaption:	ER 25 A - u-tec
	Gear ratio [i]:	1:1
	Torque max [Nm]:	16
	Rotation max [1/min]:	6000
	Rotating direction:	same/opposite
	Coolant:	EXT
	Please note:	stronger bearing
	Center distance [mm]:	120
8 040 24 011	Universal head ± 90° adjustable ER 20	
	Weight [kg]:	3.300
	Tool drive:	DIN 5480
	Shank size [mm]:	30.00
	Shank type:	VDI
	Tool adaption:	ER 20
	Gear ratio [i]:	1:1
	Torque max [Nm]:	10
	Rotation max [1/min]:	4000
	Rotating direction:	same
	Coolant:	EXT
	Please note:	Special version
8 040 24 073	Universal head ± 90° adjustable ER 16 AX UT	
	Version:	left
	Tool drive:	DIN 5480
	Shank size [mm]:	30.00
	Shank type:	VDI
	Tool adaption:	ER 16 A - u-tec
	Gear ratio [i]:	1:1
	Torque max [Nm]:	25
	Rotation max [1/min]:	6000
	Rotating direction:	opposite
	Coolant:	EXT
	Center distance [mm]:	88
8 040 24 082	Universal head ± 90° adjustable ER 16 AX UT IC	
	Version:	right
	Tool drive:	DIN 5480
	Shank size [mm]:	30.00
	Shank type:	VDI
	Tool adaption:	ER 16 A - u-tec
	Gear ratio [i]:	1:1
	Torque max [Nm]:	25
	Rotation max [1/min]:	6000
	Rotating direction:	opposite
	Coolant:	IC/Ext
	Pressure max [bar]:	140
	Center distance [mm]:	88

Part-#	Name	
8 040 24 085	Universal head $\pm 90^\circ$ adjustable ER 16 AX UT	
	Weight [kg]:	4.660
	Version:	right
	Tool drive:	DIN 5480
	Shank size [mm]:	30.00
	Shank type:	VDI
	Tool adaption:	ER 16 A - u-tec
	Gear ratio [i]:	1:2
	Torque max [Nm]:	12
	Rotation max [1/min]:	12000
	Rotating direction:	opposite
	Coolant:	EXT
	Center distance [mm]:	88
8 040 25 038	Universal head $\pm 90^\circ$ adjustable ER 25 AX UT	
	Weight [kg]:	4.890
	Version:	right
	Tool drive:	DIN 5480
	Shank size [mm]:	30.00
	Shank type:	VDI
	Tool adaption:	ER 25 A - u-tec
	Gear ratio [i]:	1:1
	Torque max [Nm]:	25
	Rotation max [1/min]:	6000
	Rotating direction:	opposite
	Coolant:	EXT
	Please note:	stronger bearing
	Center distance [mm]:	88
8 040 25 039	Universal head $\pm 90^\circ$ adjustable ER 25 AX UT	
	Weight [kg]:	4.900
	Version:	left
	Tool drive:	DIN 5480
	Shank size [mm]:	30.00
	Shank type:	VDI
	Tool adaption:	ER 25 A - u-tec
	Gear ratio [i]:	1:1
	Torque max [Nm]:	25
	Rotation max [1/min]:	6000
	Rotating direction:	opposite
	Coolant:	EXT
	Please note:	stronger bearing
	Center distance [mm]:	88
8 040 25 042	Universal head $\pm 90^\circ$ adjustable ER 25 AX UT IC	
	Weight [kg]:	4.840
	Version:	left
	Tool drive:	DIN 5480
	Shank size [mm]:	30.00
	Shank type:	VDI
	Tool adaption:	ER 25 A - u-tec
	Gear ratio [i]:	1:1
	Torque max [Nm]:	25
	Rotation max [1/min]:	6000
	Rotating direction:	opposite
	Coolant:	IC/Ext
	Pressure max [bar]:	140
	Please note:	stronger bearing

Part-#	Name	
	Center distance [mm]:	88
8 200 20 000	Plug Z2-30 K	
	Weight [kg]:	0.060
	Shank size [mm]:	30.00
	Shank type:	VDI
8 200 20 005	Plug Z2-30 S	
	Weight [kg]:	0.740
	Shank size [mm]:	30.00
	Shank type:	VDI
8 202 20 012	Basic holder longitudinal seat FN 12	
	Weight [kg]:	1.160
	Version:	universal
	Shank size [mm]:	30.00
	Shank type:	VDI
	Tool adaption:	Interface FN 12
	Coolant:	EXT
8 210 26 011	Tool holder HT 4 IC	
	Weight [kg]:	1.270
	Version:	right
	Shank size [mm]:	30.00
	Shank type:	VDI
	Tool adaption:	HT 4
	Coolant:	IC/Ext
8 210 26 012	Tool holder HT 4 IC	
	Version:	left
	Shank size [mm]:	30.00
	Shank type:	VDI
	Tool adaption:	HT 4
	Coolant:	IC/Ext
8 230 27 038	Boring bar holder Ø 28	
	Version:	right
	Shank size [mm]:	30.00
	Shank type:	VDI
	Tool adaption:	Ø 28
	Coolant:	IC/Ext
	Please note:	demountable in left version
	Center distance [mm]:	100
8 230 28 036	Boring bar holder Ø 32	
	Notation:	offset
	Version:	right
	Shank size [mm]:	30.00
	Shank type:	VDI
	Tool adaption:	Ø 32
	Coolant:	IC/Ext
	Center distance [mm]:	100

Part-#	Name	
8 230 28 037	Boring bar holder Ø 32	
	Weight [kg]:	4.740
	Notation:	offset
	Version:	right
	Shank size [mm]:	30.00
	Shank type:	VDI
	Tool adaption:	Ø 32
	Coolant:	IC/Ext
	Please note:	Offset dimension from center VDI shaft 35 mm
	Center distance [mm]:	100
8 230 28 056	Boring bar holder Ø 32	
	Weight [kg]:	5.670
	Notation:	offset
	Version:	right
	Shank size [mm]:	30.00
	Shank type:	VDI
	Tool adaption:	Ø 32
	Coolant:	IC/Ext
	Please note:	with fixation rail
	Center distance [mm]:	120
8 230 29 005	Boring bar holder Ø 40	
	Weight [kg]:	4.480
	Version:	right
	Shank size [mm]:	30.00
	Shank type:	VDI
	Tool adaption:	Ø 40
	Coolant:	IC/Ext
	Please note:	demountable in left version
	Center distance [mm]:	100
8 231 25 009	Collet chuck holder ER 25	
	Weight [kg]:	4.000
	Version:	left
	Shank size [mm]:	30.00
	Shank type:	VDI
	Tool adaption:	ER 25
	Coolant:	IC/Ext
	Please note:	demountable in right version
	Center distance [mm]:	100
8 231 25 015	Collet chuck holder ER 25	
	Version:	left
	Shank size [mm]:	30.00
	Shank type:	VDI
	Tool adaption:	ER 25
	Coolant:	IC/Ext
	Please note:	demountable in right version
	Center distance [mm]:	120
8 231 26 013	Collet chuck holder ER 32	
	Weight [kg]:	4.360
	Notation:	offset
	Version:	left
	Shank size [mm]:	30.00
	Shank type:	VDI
	Tool adaption:	ER 32

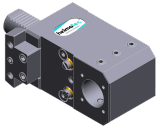
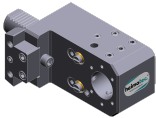
Part-#	Name	
	Coolant:	IC/Ext
	Center distance [mm]:	100
8 231 26 018	Tool holder HT 4	
	Weight [kg]:	3.940
	Version:	left
	Shank size [mm]:	30.00
	Shank type:	VDI
	Tool adaption:	HT 4
	Coolant:	IC/Ext
	Please note:	demountable in right version
	Center distance [mm]:	100
8 231 26 037	Boring bar holder Ø 20	
	Weight [kg]:	4.990
	Version:	left
	Shank size [mm]:	30.00
	Shank type:	VDI
	Tool adaption:	Ø 20
	Coolant:	IC/Ext
	Please note:	demountable in right version
	Center distance [mm]:	100
8 231 27 027	Boring bar holder Ø 1 1/4"	
	Weight [kg]:	4.600
	Version:	left
	Shank size [mm]:	30.00
	Shank type:	VDI
	Tool adaption:	Ø 1 1/4" (31,75mm)
	Coolant:	IC/Ext
	Please note:	demountable in right version
	Center distance [mm]:	100
8 231 28 007	Boring bar holder Ø 32	
	Weight [kg]:	4.000
	Notation:	offset
	Version:	left
	Shank size [mm]:	30.00
	Shank type:	VDI
	Tool adaption:	Ø 32
	Coolant:	IC/Ext
	Center distance [mm]:	100
8 231 28 008	Boring bar holder Ø 32	
	Weight [kg]:	4.200
	Version:	left
	Shank size [mm]:	30.00
	Shank type:	VDI
	Tool adaption:	Ø 32
	Coolant:	IC/Ext
	Please note:	demountable in right version
	Center distance [mm]:	85

Part-#	Name	
8 231 28 009	Boring bar holder Ø 32	
	Weight [kg]:	4.740
	Version:	left
	Shank size [mm]:	30.00
	Shank type:	VDI
	Tool adaption:	Ø 32
	Coolant:	IC/Ext
	Please note:	demountable in right version
Center distance [mm]:	100	
8 231 28 014	Boring bar holder Ø 32	
	Weight [kg]:	4.100
	Notation:	offset
	Version:	left
	Shank size [mm]:	30.00
	Shank type:	VDI
	Tool adaption:	Ø 32
	Coolant:	IC/Ext
Center distance [mm]:	100	
8 231 28 016	Boring bar holder Ø 32	
	Notation:	offset
	Version:	left
	Shank size [mm]:	30.00
	Shank type:	VDI
	Tool adaption:	Ø 32
	Coolant:	IC/Ext
	Please note:	Offset dimension from center VDI shaft 35 mm
Center distance [mm]:	100	
8 231 28 024	Tool holder HT 6	
	Notation:	offset
	Version:	left
	Shank size [mm]:	30.00
	Shank type:	VDI
	Tool adaption:	HT 6
	Coolant:	IC/Ext
	Please note:	with fixation rail
Center distance [mm]:	100	
8 231 29 003	Boring bar holder Ø 40	
	Weight [kg]:	4.490
	Version:	left
	Shank size [mm]:	30.00
	Shank type:	VDI
	Tool adaption:	Ø 40
	Coolant:	IC/Ext
	Please note:	demountable in right version
Center distance [mm]:	100	
8 236 28 007	Tool holder HT 6	
	Weight [kg]:	5.830
	Notation:	offset
	Version:	doubletoothed
	Shank size [mm]:	30.00
	Shank type:	VDI
	Tool adaption:	HT 6
Coolant:	IC/Ext	

Part-#	Name	
	Please note:	with fixation rail
	Center distance [mm]:	120
8 239 25 018	Double collet chuck holder ER 25	
	Weight [kg]:	4.260
	Shank size [mm]:	30.00
	Shank type:	VDI
	Tool adaption:	ER 25
	Coolant:	IC/Ext
	Center distance [mm]:	100
8 239 27 011	Double boring bar holder Ø 25	
	Weight [kg]:	6.580
	Shank size [mm]:	30.00
	Shank type:	VDI
	Tool adaption:	Ø 25
	Coolant:	IC/Ext
	Center distance [mm]:	100
8 239 28 009	Double boring bar holder Ø 32	
	Weight [kg]:	6.260
	Shank size [mm]:	30.00
	Shank type:	VDI
	Tool adaption:	Ø 32
	Coolant:	IC/Ext
	Center distance [mm]:	100
8 251 24 002	Combi double turning holder sq. 20	
	Weight [kg]:	4.600
	Shank size [mm]:	30.00
	Shank type:	VDI
	Tool adaption:	Sq. 20
	Coolant:	EXT
8 262 29 022	Stock stop VDI 30 - Ø 60 OD turret	
	Weight [kg]:	4.220
	Notation:	rotating
	Version:	left
	Shank size [mm]:	30.00
	Shank type:	VDI
	Rotation max [1/min]:	8000
	Coolant:	no
	Please note:	Length adjustable
	Center distance [mm]:	100
8 320 22 019	Cut-off holder, height adjustable SH 26 IC	
	Weight [kg]:	1.510
	Version:	universal
	Shank size [mm]:	30.00
	Shank type:	VDI
	Tool adaption:	Clampshaft SH 26
	Coolant:	IC/Ext
	Pressure max [bar]:	70

Part-#	Name	
8 320 23 013	Cut-off holder, height adjustable SH 32 IC	
	Weight [kg]:	1.720
	Version:	universal
	Shank size [mm]:	30.00
	Shank type:	VDI
	Tool adaption:	Clampshaft SH 32
	Coolant:	IC/Ext
	Pressure max [bar]:	70
8 320 23 018	Cut-off holder, height adjustable SH 32 IC	
	Weight [kg]:	1.910
	Version:	universal
	Shank size [mm]:	30.00
	Shank type:	VDI
	Tool adaption:	Clampshaft SH 32
	Coolant:	IC/Ext
	Pressure max [bar]:	70
	Please note:	Clampshaft internal
8 320 23 038	Cut-off holder, height adjustable SH 32 IC	
	Weight [kg]:	1.900
	Version:	universal
	Shank size [mm]:	30.00
	Shank type:	VDI
	Tool adaption:	Clampshaft SH 32
	Coolant:	IC/Ext
	Pressure max [bar]:	70
	Please note:	Clampshaft internal, check applicability!
8 320 29 002	Cut-off holder, height adjustable 845 IC	
	Weight [kg]:	1.630
	Version:	universal
	Shank size [mm]:	30.00
	Shank type:	VDI
	Tool adaption:	 System 845
	Coolant:	IC
	Pressure max [bar]:	70



heimatec.u-tec®

heimatec.com

Products / Tool change systems /
u-tec® Tool-changing system



versions see catalog



heimatec.easy-quick

heimatec.com

Products / Tool change systems /
easy-quick HT quick-changing system



versions see catalog



heimatec.Capto™

heimatec.com

Products / Tool change systems /
heimatec.Capto™ quick-changing system



versions see catalog

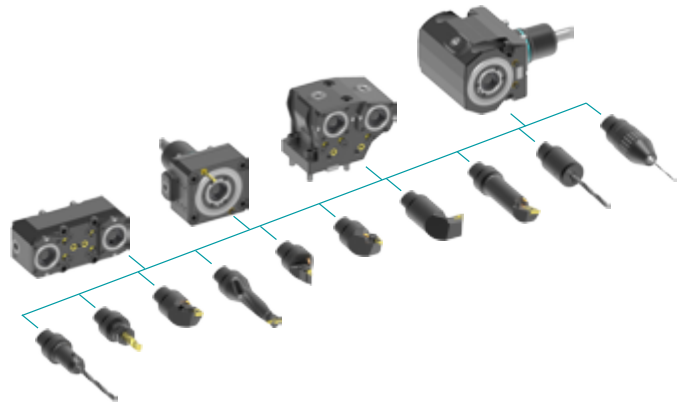

heimatec.accessories

heimatec.com

Products / Accessories



versions see catalog





● heimatec overseas branches

○ global representations of heimatec

heimatec[®]

heimatec GmbH
Präzisionswerkzeuge
Carl-Benz-Str. 4
77871 Renchen
Germany

T +49 7843 9466 0
www.heimatec.com
info@heimatec.com

Please find the contact details of our worldwide trading partners on our website:
<https://heimatec.com/business-partners>