

Nakamura
WT- 20-I



High-tech from heimatec - heimatec - Tools and systems for productive turning and milling

heimatec belongs to the international technology and quality leaders for precision tools and specializes in the development and production of high-precision static and live tools for all CNC lathes, CNC turn-/mill machines and CNC machining centers.

The range of products* spans from static BMT and VDI tool holders, live tools up to highly complex customer-specific individual solutions. heimatec, headquartered in Renchen, has a own subsidiary in Asia and India and numerous representatives as well as trading partners all over the world.

*OUR PRODCUTS

Static tool holders

Live tool units

Precision tools

Tools for turning and machining centres

Tools for swiss type lathes

Tool changing and uick-change systems



Tool systems for gear production

Digital tool management

This catalogue, including all its parts, is protected by copyright. Any use outside the restricted limitations of the Copyright Act without the consent of heimatec is inadmissible and liable to prosecution. This applies in particular to duplication, translation, microfilming and storage and processing in electronic systems.

heimatec GmbH reserves the right to make technical changes at any time without giving prior notice. This applies in particular to adjustments at any time to meet new or changed international standards, or in case of further developments of our products or manufacturing processes.

The current version of our General Terms and Conditions can be found on our website.

Part-#	Name	
8 010 54 040	Axial drilling and milling head ER 20	
	Weight [kg]:	1.800
	Tool drive:	Bevel gear
	Shank size [mm]:	55.00
	Shank type:	BMT
	Tool adaption:	ER 20
	Gear ratio [i]:	1:1
	Torque max [Nm]:	25
	Rotation max [1/min]:	6000
	Rotating direction:	same
	Coolant:	EXT
	Please note:	Price without bevel gear
8 030 54 067	Radial drilling and milling head ER 20	
	Tool drive:	Bevel gear
	Shank size [mm]:	55.00
	Shank type:	BMT
	Tool adaption:	ER 20
	Gear ratio [i]:	1:1
	Torque max [Nm]:	25
	Rotation max [1/min]:	6000
	Rotating direction:	opposite
	Coolant:	EXT
	Please note:	Price without bevel gear
	Center distance [mm]:	55
8 200 03 002	Cover plate	
	Weight [kg]:	0.300
	Shank type:	BMT
8 200 10 002	Tool blank	
	Weight [kg]:	4.190
	Notation:	180° reversible
	Shank type:	BMT
	Machine adaption:	Centering key b 20
	Please note:	Housing rigid
8 202 10 006	Basic holder longitudinal seat FN 12	
	Weight [kg]:	0.960
	Notation:	180° reversible
	Shank type:	BMT
	Machine adaption:	Centering key b 20
	Tool adaption:	Interface FN 12
	Coolant:	EXT
8 209 10 000	Tool blank	
	Weight [kg]:	4.580
	Shank type:	BMT
	Machine adaption:	Centering key b 20
	Coolant:	EXT

Part-#	Name	
8 209 11 000	Adapter for VDI 20	
	Shank type:	BMT
	Machine adaption:	Centering key b 20
	Tool adaption:	DIN 69880 - 20
	Coolant:	EXT
	Center distance [mm]:	55
8 209 12 000	Adapter for VDI 30	
	Weight [kg]:	2.750
	Employment for:	Outside operation
	Shank type:	BMT
	Machine adaption:	Centering key b 20
	Tool adaption:	DIN 69880 - 30
	Coolant:	EXT
	Center distance [mm]:	35
8 209 12 001	Adapter for VDI 30	
	Weight [kg]:	3.140
	Employment for:	Inside operation
	Shank type:	BMT
	Machine adaption:	Centering key b 20
	Tool adaption:	DIN 69880 - 30
	Coolant:	EXT
	Center distance [mm]:	65
8 209 14 002	Adapter for VDI 40	
	Weight [kg]:	2.720
	Shank type:	BMT
	Machine adaption:	Centering key b 20
	Tool adaption:	DIN 69880 - 40
	Coolant:	EXT
	Center distance [mm]:	35
8 209 14 003	Adapter for VDI 40 offset	
	Shank type:	BMT
	Machine adaption:	Centering key b 20
	Tool adaption:	DIN 69880 - 40
	Coolant:	EXT
	Center distance [mm]:	65
8 209 19 000	Adapter 45 ° for Ecoroll WKT EG5-1-SL00	
	Weight [kg]:	2.590
	Notation:	180° reversible
	Shank type:	BMT
	Machine adaption:	Centering key b 20
	Coolant:	EXT
8 209 58 000	Adapter for sensor m&h RWP 38.41	
	Notation:	180° reversible
	Shank size [mm]:	55.00
	Shank type:	BMT
	Tool adaption:	Ø 32
	Coolant:	no

Part-#	Name	
8 209 58 001	Adapter for sensor m&h IRP 40.01	
	Weight [kg]:	1.340
	Notation:	180° reversible
	Shank size [mm]:	55.00
	Shank type:	BMT
	Tool adaption:	Ø 32
	Coolant:	no
8 209 58 002	Adapter for sensor m&h IRP 40.02	
	Weight [kg]:	1.520
	Notation:	180° reversible
	Shank size [mm]:	55.00
	Shank type:	BMT
	Coolant:	no
8 209 58 003	Adapter for sensor Renishaw RLP	
	Weight [kg]:	1.700
	Notation:	180° reversible
	Shank size [mm]:	55.00
	Shank type:	BMT
	Coolant:	no
8 224 11 002	Turning holder sq. 20	
	Weight [kg]:	2.420
	Employment for:	right cutting tools
	Shank type:	BMT
	Machine adaption:	Centering key b 20
	Tool adaption:	Sq. 20
	Coolant:	EXT
8 224 11 003	Cut-off holder sq. 20	
	Weight [kg]:	1.040
	Employment for:	right cutting tools
	Version:	Edge on side of turret
	Shank type:	BMT
	Machine adaption:	Centering key b 20
	Tool adaption:	Sq. 20
	Coolant:	EXT
8 224 11 005	Cut-off holder sq. 20	
	Weight [kg]:	1.100
	Employment for:	left cutting tools
	Version:	Edge on center of turret
	Shank type:	BMT
	Machine adaption:	Centering key b 20
	Tool adaption:	Sq. 20
	Coolant:	EXT
8 224 11 016	Cut-off holder sq. 3/4" R 1441	
	Weight [kg]:	1.110
	Employment for:	right cutting tools
	Version:	Edge on side of turret
	Shank type:	BMT
	Machine adaption:	Centering key b 20
	Tool adaption:	Sq. 3/4" (19,05mm)
	Coolant:	EXT

Part-#	Name	
8 224 11 022	Cut-off holder sq. 20	
	Weight [kg]:	1.350
	Employment for:	right cutting tools
	Version:	Edge on side of turret
	Shank type:	BMT
	Machine adaption:	Centering key b 20
	Tool adaption:	Sq. 20
	Coolant:	EXT
8 224 12 005	Cut-off holder sq. 25	
	Weight [kg]:	1.480
	Shank type:	BMT
	Machine adaption:	Centering key b 20
	Tool adaption:	Sq. 25
	Coolant:	EXT
8 224 12 006	Cut-off holder sq. 25	
	Weight [kg]:	1.480
	Employment for:	left cutting tools
	Version:	Edge on center of turret
	Shank type:	BMT
	Machine adaption:	Centering key b 20
	Tool adaption:	Sq. 25
	Coolant:	EXT
8 224 13 004	Cut-off holder SH 32	
	Weight [kg]:	1.000
	Employment for:	Cut-off tool 32
	Version:	Clampshaft on turret center
	Shank type:	BMT
	Machine adaption:	Centering key b 20
	Tool adaption:	Clampshaft SH 32
	Coolant:	EXT
8 224 13 007	Cut-off holder SH 32	
	Weight [kg]:	1.190
	Employment for:	Cut-off tool 32
	Version:	Clampshaft on turret side
	Shank type:	BMT
	Machine adaption:	Centering key b 20
	Tool adaption:	Clampshaft SH 32
	Coolant:	EXT
8 224 13 013	Cut-off holder SH 32	
	Weight [kg]:	1.480
	Employment for:	Cut-off tool 32
	Version:	Clampshaft on turret side
	Shank type:	BMT
	Machine adaption:	Centering key b 20
	Tool adaption:	Clampshaft SH 32
	Coolant:	EXT
	Please note:	Special

Part-#	Name	
8 224 13 021	Cut-off holder SH 32 IC	
	Weight [kg]:	1.030
	Employment for:	Cut-off tool 32
	Version:	Clampshaft on turret center
	Shank type:	BMT
	Machine adaption:	Centering key b 20
	Tool adaption:	Clampshaft SH 32
	Coolant:	IC/Ext
8 224 14 000	Universal turning holder sq. 20	
	Weight [kg]:	1.730
	Notation:	180° reversible
	Shank type:	BMT
	Machine adaption:	Centering key b 20
	Tool adaption:	Sq. 20
		Sq. 20
	Coolant:	EXT
	Please note:	with spacer strip
8 224 14 016	Universal turning holder sq. 20 IC	
	Weight [kg]:	2.950
	Notation:	180° reversible
	Shank type:	BMT
	Machine adaption:	Centering key b 20
	Tool adaption:	Sq. 20
	Coolant:	IC/Ext
	Pressure max [bar]:	100
	Please note:	Key rail
8 224 15 002	Universal turning holder sq. 25/20	
	Weight [kg]:	2.800
	Notation:	180° reversible
	Shank type:	BMT
	Machine adaption:	Centering key b 20
	Tool adaption:	Sq. 25
		Sq. 25
	Coolant:	EXT
	Please note:	With spacer strip for sq. 20
8 224 15 012	Universal turning holder sq. 1"	
	Weight [kg]:	2.720
	Shank type:	BMT
	Machine adaption:	Centering key b 20
	Tool adaption:	Sq. 1" (25,4mm)
		Sq. 1" (25,4mm)
	Coolant:	EXT
8 224 15 046	Universal turning holder sq. 25/20	
	Weight [kg]:	5.520
	Shank type:	BMT
	Machine adaption:	Centering key b 20
	Tool adaption:	Sq. 25
		Sq. 25
	Coolant:	EXT
	Please note:	Check applicability! with spacer strip for

Part-#	Name	
8 224 15 062	Universal turning holder sq. 25 IC	
	Weight [kg]:	3.100
	Shank type:	BMT
	Machine adaption:	Centering key b 20
	Tool adaption:	Sq. 25
		Sq. 25
	Coolant:	IC/Ext
	Pressure max [bar]:	100
	Please note:	Key rail
8 224 15 063	Universal turning holder sq. 1" IC	
	Weight [kg]:	3.100
	Shank type:	BMT
	Machine adaption:	Centering key b 20
	Tool adaption:	Sq. 1" (25,4mm)
		Sq. 1" (25,4mm)
	Coolant:	IC/Ext
	Pressure max [bar]:	100
	Please note:	Key rail
8 225 11 002	Cut-off holder sq. 20 R 1432	
	Weight [kg]:	1.120
	Employment for:	left cutting tools
	Version:	Edge on side of turret
	Shank type:	BMT
	Machine adaption:	Centering key b 20
	Tool adaption:	Sq. 20
	Coolant:	EXT
8 225 11 005	Cut-off holder sq. 20	
	Weight [kg]:	1.170
	Employment for:	right cutting tools
	Version:	Edge on center of turret
	Shank type:	BMT
	Machine adaption:	Centering key b 20
	Tool adaption:	Sq. 20
	Coolant:	EXT
8 225 11 009	Cut-off holder sq. 3/4" R 1442	
	Weight [kg]:	1.110
	Employment for:	left cutting tools
	Version:	Edge on side of turret
	Shank type:	BMT
	Machine adaption:	Centering key b 20
	Tool adaption:	Sq. 3/4" (19,05mm)
	Coolant:	EXT
8 225 11 012	Cut-off holder sq. 3/4"	
	Weight [kg]:	1.200
	Employment for:	right cutting tools
	Version:	Edge on center of turret
	Shank type:	BMT
	Machine adaption:	Centering key b 20
	Tool adaption:	Sq. 3/4" (19,05mm)
	Coolant:	EXT

Part-#	Name	
8 240 14 017	Boring bar holder Ø 12 - slotted	
	Weight [kg]:	2.900
	Notation:	180° reversible
	Version:	slotted
	Shank type:	BMT
	Machine adaption:	Centering key b 20
	Tool adaption:	Ø 12
	Coolant:	EXT
	Pressure max [bar]:	100
	Center distance [mm]:	75
8 240 14 022	Boring bar holder Ø 10 - slotted	
	Weight [kg]:	2.900
	Notation:	180° reversible
	Version:	slotted
	Shank type:	BMT
	Machine adaption:	Centering key b 20
	Tool adaption:	Ø 10
	Coolant:	EXT
	Pressure max [bar]:	100
	Center distance [mm]:	75
8 240 15 002	Tool holder ABS 50 IC/Ext	
	Weight [kg]:	3.560
	Notation:	offset
	Shank type:	BMT
	Machine adaption:	Centering key b 20
	Tool adaption:	ABS 50
	Coolant:	IC/Ext
	Center distance [mm]:	75
8 240 15 003	Boring bar holder Ø 16 DIN 1835 E	
	Weight [kg]:	3.020
	Shank type:	BMT
	Machine adaption:	Centering key b 20
	Tool adaption:	Whistle-Notch (DIN 1835 E) 16
	Coolant:	IC/Ext
	Center distance [mm]:	75
8 240 15 004	Tool holder C 3 IC	
	Weight [kg]:	3.580
	Notation:	180° reversible; offset
	Shank type:	BMT
	Machine adaption:	Centering key b 20
	Tool adaption:	heimatec Capto(TM) C 3
	Coolant:	IC
	Center distance [mm]:	75
8 240 15 006	Collet chuck holder ER 25	
	Weight [kg]:	3.520
	Notation:	180° reversible
	Shank type:	BMT
	Machine adaption:	Centering key b 20
	Tool adaption:	ER 25
	Coolant:	IC/Ext
	Please note:	Insert reversible

Part-#	Name	
	Center distance [mm]:	75
8 240 15 007	Insert drill holder 16 IC	
	Weight [kg]:	4.540
	Notation:	180° reversible
	Shank type:	BMT
	Tool adaption:	Whistle-Notch (DIN 1835 E) 16
	Coolant:	IC
	Center distance [mm]:	75
8 240 15 019	Collet chuck holder ER 25 AX UT IC	
	Weight [kg]:	3.380
	Notation:	180° reversible; offset
	Shank type:	BMT
	Machine adaption:	Centering key b 20
	Tool adaption:	ER 25 A - u-tec
	Coolant:	IC/Ext
	Center distance [mm]:	75
8 240 15 039	Boring bar holder Ø 16 - slotted	
	Weight [kg]:	3.000
	Notation:	180° reversible
	Shank type:	BMT
	Machine adaption:	Centering key b 20
	Tool adaption:	Ø 16
	Coolant:	EXT
	Center distance [mm]:	75
8 240 16 001	Boring bar holder Ø 20 DIN 1835 E	
	Weight [kg]:	2.960
	Shank type:	BMT
	Machine adaption:	Centering key b 20
	Tool adaption:	Whistle-Notch (DIN 1835 E) 20
	Coolant:	IC
	Center distance [mm]:	75
8 240 16 004	Tool holder HT 4 IC	
	Weight [kg]:	2.890
	Notation:	180° reversible; offset
	Shank type:	BMT
	Machine adaption:	Centering key b 20
	Tool adaption:	HT 4
	Coolant:	IC/Ext
	Center distance [mm]:	75
8 240 16 005	Boring bar holder Ø 24	
	Notation:	180° reversible
	Version:	Special
	Shank type:	BMT
	Machine adaption:	Centering key b 20
	Tool adaption:	Ø 24
	Coolant:	IC/Ext
	Please note:	Housing rigid
	Center distance [mm]:	75

Part-#	Name	
8 240 16 006	Tool holder HT 4 IC	
	Weight [kg]:	3.340
	Notation:	offset
	Version:	Special
	Shank type:	BMT
	Machine adaption:	Centering key b 20
	Tool adaption:	HT 4
	Coolant:	IC/Ext
	Center distance [mm]:	75
8 240 16 008	Collet chuck holder ER 32	
	Weight [kg]:	3.200
	Notation:	180° reversible
	Shank type:	BMT
	Machine adaption:	Centering key b 20
	Tool adaption:	ER 32
	Coolant:	IC/Ext
	Please note:	Insert reversible
	Center distance [mm]:	75
8 240 16 009	Insert drill holder 20 IC	
	Weight [kg]:	4.480
	Notation:	180° reversible
	Shank type:	BMT
	Tool adaption:	Whistle-Notch (DIN 1835 E) 20
	Coolant:	IC
	Center distance [mm]:	75
8 240 16 020	Tool holder HT 4 IC	
	Weight [kg]:	5.900
	Notation:	offset; 180° reversible
	Version:	Special
	Shank type:	BMT
	Machine adaption:	Centering key b 20
	Tool adaption:	HT 4
	Coolant:	IC/Ext
	Center distance [mm]:	75
8 240 16 030	Boring bar holder Ø 20	
	Weight [kg]:	3.940
	Notation:	180° reversible
	Shank type:	BMT
	Machine adaption:	Centering key b 20
	Tool adaption:	Ø 20
	Coolant:	IC/Ext
	Please note:	Housing rigid
	Center distance [mm]:	75
8 240 16 034	Collet chuck holder ER 32	
	Weight [kg]:	3.060
	Notation:	180° reversible; offset
	Shank type:	BMT
	Machine adaption:	Centering key b 20
	Tool adaption:	ER 32
	Coolant:	IC/Ext
	Center distance [mm]:	75

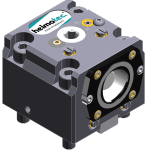
Part-#	Name	
8 240 16 040	Tool holder C 4 IC	
	Weight [kg]:	3.130
	Notation:	180° reversible
	Version:	offset; right
	Shank type:	BMT
	Machine adaption:	Centering key b 20
	Tool adaption:	heimatec Capto(TM) C 4
	Coolant:	IC/Ext
	Please note:	Check applicability; note tool length!
	Center distance [mm]:	75
8 240 16 045	Tool holder C 4 IC	
	Weight [kg]:	2.960
	Notation:	180° reversible
	Version:	offset; right
	Shank type:	BMT
	Machine adaption:	Centering key b 20
	Tool adaption:	heimatec Capto(TM) C 4
	Coolant:	IC
	Please note:	Check applicability; note tool length!
	Center distance [mm]:	75
8 240 16 046	Tool holder C 4 IC	
	Weight [kg]:	3.480
	Notation:	180° reversible
	Version:	right
	Shank type:	BMT
	Machine adaption:	Centering key b 20
	Tool adaption:	heimatec Capto(TM) C 4
	Coolant:	IC
	Please note:	Check applicability; note tool length!
	Center distance [mm]:	75
8 240 16 051	Tool holder C 4 IC	
	Weight [kg]:	3.430
	Notation:	180° reversible
	Version:	left
	Shank type:	BMT
	Machine adaption:	Centering key b 20
	Tool adaption:	heimatec Capto(TM) C 4
	Coolant:	IC
	Please note:	Check applicability; note tool length!
	Center distance [mm]:	75
8 240 16 054	Tool holder C 4 IC	
	Weight [kg]:	2.840
	Notation:	180° reversible
	Version:	left; special
	Shank type:	BMT
	Machine adaption:	Centering key b 20
	Tool adaption:	heimatec Capto(TM) C 4
	Coolant:	IC/Ext
	Please note:	Check applicability; note tool length!
	Center distance [mm]:	40

Part-#	Name	
8 240 16 077	Boring bar holder Ø 20 - slotted	
	Weight [kg]:	3.120
	Notation:	180° reversible
	Version:	slotted
	Shank type:	BMT
	Machine adaption:	Centering key b 20
	Tool adaption:	Ø 20
	Coolant:	EXT
	Pressure max [bar]:	100
	Center distance [mm]:	75
8 240 17 005	Boring bar holder Ø 25	
	Weight [kg]:	3.820
	Notation:	180° reversible
	Shank type:	BMT
	Machine adaption:	Centering key b 20
	Tool adaption:	Ø 25
	Coolant:	IC/Ext
	Please note:	Housing rigid
	Center distance [mm]:	75
8 240 17 007	Boring bar holder Ø 25	
	Weight [kg]:	2.320
	Notation:	180° reversible
	Version:	offset
	Shank type:	BMT
	Machine adaption:	Centering key b 20
	Tool adaption:	Ø 25
	Coolant:	IC/Ext
	Please note:	Housing rigid
	Center distance [mm]:	75
8 240 17 008	Boring bar holder Ø 25 DIN 1835 E	
	Weight [kg]:	3.210
	Notation:	offset; 180° reversible
	Version:	Special
	Shank type:	BMT
	Machine adaption:	Centering key b 20
	Tool adaption:	Whistle-Notch (DIN 1835 E) 25
	Coolant:	IC/Ext
	Center distance [mm]:	75
8 240 17 011	Boring bar holder Ø 25,4 (1")	
	Weight [kg]:	3.800
	Notation:	180° reversible
	Shank type:	BMT
	Machine adaption:	Centering key b 20
	Tool adaption:	Ø 1" (25,4mm)
	Coolant:	IC/Ext
	Pressure max [bar]:	140
	Please note:	Housing rigid
	Center distance [mm]:	75

Part-#	Name	
8 240 17 012	Boring bar holder Ø 25	
	Weight [kg]:	5.920
	Notation:	180° reversible
	Shank type:	BMT
	Machine adaption:	Centering key b 20
	Tool adaption:	Ø 25
	Coolant:	IC/Ext
	Please note:	Housing rigid
	Center distance [mm]:	117,5
8 240 17 016	Boring bar holder Ø 30	
	Notation:	180° reversible
	Version:	Special
	Shank type:	BMT
	Machine adaption:	Centering key b 20
	Tool adaption:	Ø 30
	Coolant:	IC/Ext
	Please note:	Housing rigid
	Center distance [mm]:	75
8 240 17 021	Collet chuck holder ER 40	
	Weight [kg]:	3.710
	Notation:	180° reversible
	Shank type:	BMT
	Machine adaption:	Centering key b 20
	Tool adaption:	ER 40
	Coolant:	IC/Ext
	Please note:	Insert reversible
	Center distance [mm]:	75
8 240 17 023	Insert drill holder 25 IC	
	Weight [kg]:	4.380
	Notation:	180° reversible
	Shank type:	BMT
	Tool adaption:	Whistle-Notch (DIN 1835 E) 25
	Coolant:	IC
	Center distance [mm]:	75
8 240 17 031	Boring bar holder Ø 30	
	Notation:	180° reversible
	Version:	Special
	Shank type:	BMT
	Machine adaption:	Centering key b 20
	Tool adaption:	Ø 30
	Coolant:	EXT
	Center distance [mm]:	112
8 240 17 032	Boring bar holder Ø 30	
	Notation:	180° reversible
	Version:	Special
	Shank type:	BMT
	Machine adaption:	Centering key b 20
	Tool adaption:	Ø 30
	Coolant:	EXT
	Center distance [mm]:	105





Part-#	Name	
8 240 17 049	Boring bar holder Ø 1" offset	
	Weight [kg]:	2.450
	Notation:	180° reversible
	Version:	offset
	Shank type:	BMT
	Machine adaption:	Centering key b 20
	Tool adaption:	Ø 1" (25,4mm)
	Coolant:	IC/Ext
	Please note:	Housing rigid
	Center distance [mm]:	75
8 240 17 061	Boring bar holder Ø 1"	
	Weight [kg]:	2.300
	Shank type:	BMT
	Machine adaption:	Centering key b 20
	Tool adaption:	Ø 1" (25,4mm)
	Coolant:	IC/Ext
	Center distance [mm]:	55
8 240 17 065	Boring bar holder Ø 25 - slotted	
	Weight [kg]:	3.670
	Notation:	180° reversible
	Shank type:	BMT
	Machine adaption:	Centering key b 20
	Tool adaption:	Ø 25
	Coolant:	EXT
	Please note:	Housing rigid
	Center distance [mm]:	75
8 240 17 078	Boring bar holder Ø 1 1/4" - slotted	
	Weight [kg]:	3.440
	Notation:	180° reversible
	Shank type:	BMT
	Machine adaption:	Centering key b 20
	Tool adaption:	Ø 1 1/4" (31,75mm)
	Coolant:	EXT
	Please note:	Housing rigid
	Center distance [mm]:	75
8 240 17 096	Tool holder C 5 IC	
	Weight [kg]:	5.030
	Notation:	180° reversible
	Version:	right
	Shank type:	BMT
	Machine adaption:	Centering key b 20
	Tool adaption:	heimatec Capto(TM) C 5
	Coolant:	IC
	Please note:	Check applicability; note tool length!
	Center distance [mm]:	75
8 240 17 106	Boring bar holder Ø 25	
	Weight [kg]:	4.800
	Notation:	180° reversible
	Shank type:	BMT
	Machine adaption:	Centering key b 20
	Tool adaption:	Ø 25
	Coolant:	IC/Ext



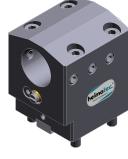

Part-#	Name	
	Please note:	Check applicability! housing rigid
	Center distance [mm]:	95
8 240 17 114	Boring bar holder Ø 1"	
	Weight [kg]:	4.760
	Notation:	180° reversible
	Shank type:	BMT
	Machine adaption:	Centering key b 20
	Tool adaption:	Ø 1" (25,4mm)
	Coolant:	IC/Ext
	Please note:	Check applicability! housing rigid
	Center distance [mm]:	95
8 240 17 115	Boring bar holder Ø 1 1/4"	
	Weight [kg]:	4.620
	Notation:	180° reversible
	Shank type:	BMT
	Machine adaption:	Centering key b 20
	Tool adaption:	Ø 1 1/4" (31,75mm)
	Coolant:	IC/Ext
	Please note:	Check applicability! housing rigid
	Center distance [mm]:	95
8 240 17 116	Boring bar holder Ø 1 1/4"	
	Weight [kg]:	2.440
	Notation:	180° reversible
	Shank type:	BMT
	Machine adaption:	Centering key b 20
	Tool adaption:	Ø 1 1/4" (31,75mm)
	Coolant:	IC/Ext
	Please note:	Housing rigid
	Center distance [mm]:	75
8 240 18 010	Boring bar holder Ø 32	
	Weight [kg]:	3.640
	Notation:	180° reversible
	Shank type:	BMT
	Machine adaption:	Centering key b 20
	Tool adaption:	Ø 32
	Coolant:	IC/Ext
	Pressure max [bar]:	140
	Please note:	Housing rigid
	Center distance [mm]:	75
8 240 18 011	Boring bar holder Ø 32	
	Weight [kg]:	2.680
	Shank type:	BMT
	Machine adaption:	Centering key b 20
	Tool adaption:	Ø 32
	Coolant:	IC/Ext
	Center distance [mm]:	55

Part-#	Name	
8 240 18 012	Boring bar holder Ø 32 offset	
	Weight [kg]:	2.420
	Notation:	180° reversible
	Version:	offset
	Shank type:	BMT
	Machine adaption:	Centering key b 20
	Tool adaption:	Ø 32
	Coolant:	IC/Ext
	Please note:	Housing rigid
	Center distance [mm]:	75
8 240 18 016	Boring bar holder Ø 32	
	Weight [kg]:	4.370
	Notation:	180° reversible
	Shank type:	BMT
	Machine adaption:	Centering key b 20
	Tool adaption:	Ø 32
	Coolant:	IC/Ext
	Please note:	Housing rigid
	Center distance [mm]:	90
8 240 18 021	Insert drill holder 32 IC	
	Weight [kg]:	4.200
	Notation:	180° reversible
	Shank type:	BMT
	Tool adaption:	Whistle-Notch (DIN 1835 E) 32
	Coolant:	IC
	Center distance [mm]:	75
8 240 18 033	Boring bar holder Ø 1 1/4"	
	Weight [kg]:	3.630
	Notation:	180° reversible
	Shank type:	BMT
	Machine adaption:	Centering key b 20
	Tool adaption:	Ø 1 1/4" (31,75mm)
	Coolant:	IC/Ext
	Please note:	Housing rigid
	Center distance [mm]:	75
8 240 18 037	Boring bar holder Ø 1 1/2"	
	Weight [kg]:	4.540
	Notation:	180° reversible
	Shank type:	BMT
	Machine adaption:	Centering key b 20
	Tool adaption:	Ø 1 1/2" (38,1mm)
	Coolant:	IC/Ext
	Center distance [mm]:	75
8 240 18 045	Boring bar holder Ø 32 offset	
	Weight [kg]:	4.380
	Notation:	offset
	Shank type:	BMT
	Machine adaption:	Centering key b 20
	Tool adaption:	Ø 32
	Coolant:	IC/Ext
	Please note:	Front edge ø32- adapter on turret center
	Center distance [mm]:	75

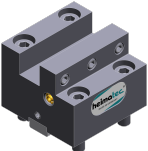
Part-#	Name	
8 240 18 085	Boring bar holder Ø 32	
	Weight [kg]:	4.605
	Notation:	180° reversible
	Shank type:	BMT
	Machine adaption:	Centering key b 20
	Tool adaption:	Ø 32
	Coolant:	IC/Ext
	Please note:	Check applicability! housing rigid
	Center distance [mm]:	95
8 240 18 098	Boring bar holder Ø 1 1/4"	
	Notation:	180° reversible
	Shank type:	BMT
	Machine adaption:	Centering key b 20
	Tool adaption:	Ø 1 1/4" (31,75mm)
	Coolant:	IC/Ext
	Please note:	Check applicability!
	Center distance [mm]:	100
8 240 18 102	Boring bar holder Ø 32 offset	
	Weight [kg]:	6.780
	Notation:	180° reversible
	Version:	offset
	Shank type:	BMT
	Machine adaption:	Centering key b 20
	Tool adaption:	Ø 32
	Coolant:	IC
	Pressure max [bar]:	100
	Please note:	Check applicability! length
	Center distance [mm]:	80
8 240 19 007	Boring bar holder Ø 40	
	Weight [kg]:	4.260
	Notation:	offset; 180° reversible
	Shank type:	BMT
	Machine adaption:	Centering key b 20
	Tool adaption:	Ø 40
	Coolant:	IC/Ext
	Center distance [mm]:	75
8 240 19 009	Boring bar holder Ø 40	
	Weight [kg]:	4.480
	Notation:	180° reversible
	Shank type:	BMT
	Machine adaption:	Centering key b 20
	Tool adaption:	Ø 40
	Coolant:	IC/Ext
	Center distance [mm]:	75
8 240 19 012	Boring bar holder Ø 40	
	Weight [kg]:	3.460
	Shank type:	BMT
	Machine adaption:	Centering key b 20
	Tool adaption:	Ø 40
	Coolant:	IC/Ext
	Please note:	Special version

Part-#	Name	
	Center distance [mm]:	75
8 240 19 025	Insert drill holder 40 IC	
	Weight [kg]:	4.740
	Notation:	180° reversible
	Shank type:	BMT
	Tool adaption:	Whistle-Notch (DIN 1835 E) 40
	Coolant:	IC
	Center distance [mm]:	75
8 240 19 105	Boring bar holder Ø 40	
	Weight [kg]:	2.400
	Notation:	180° reversible
	Shank type:	BMT
	Machine adaption:	Centering key b 20
	Tool adaption:	Ø 40
	Coolant:	IC/Ext
	Center distance [mm]:	35
8 240 19 139	Boring bar holder Ø 40	
	Weight [kg]:	4.760
	Notation:	180° reversible
	Shank type:	BMT
	Machine adaption:	Centering key b 20
	Tool adaption:	Ø 40
	Coolant:	IC
	Please note:	Check applicability!
	Center distance [mm]:	100
8 240 19 142	Boring bar holder Ø 40 offset	
	Weight [kg]:	5.000
	Notation:	offset
	Shank type:	BMT
	Machine adaption:	Centering key b 20
	Tool adaption:	Ø 40
	Coolant:	IC/Ext
	Please note:	Front edge Ø40- adapter 60mm from turret center offset
	Center distance [mm]:	75
8 240 19 143	Boring bar holder Ø 40 offset	
	Weight [kg]:	4.000
	Notation:	offset
	Shank type:	BMT
	Machine adaption:	Centering key b 20
	Tool adaption:	Ø 40
	Coolant:	IC/Ext
	Please note:	Front edge Ø40- adapter 20mm from turret center offset
	Center distance [mm]:	75
8 244 11 002	Facing holder sq. 20	
	Weight [kg]:	2.340
	Notation:	180° reversible
	Shank type:	BMT
	Machine adaption:	Centering key b 20
	Tool adaption:	Sq. 20
	Coolant:	EXT

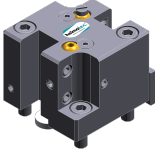

Part-#	Name	
8 244 11 009	Facing holder sq. 20	
	Weight [kg]:	4.090
	Notation:	180° reversible
	Version:	Special; extended version
	Shank type:	BMT
	Machine adaption:	Centering key b 20
	Tool adaption:	Sq. 20
	Coolant:	EXT
8 244 12 005	Facing holder sq. 1"	
	Weight [kg]:	3.570
	Shank type:	BMT
	Machine adaption:	Centering key b 20
	Tool adaption:	Sq. 1" (25,4mm)
	Coolant:	EXT
8 244 12 027	Facing holder sq. 25 IC	
	Weight [kg]:	3.640
	Shank type:	BMT
	Machine adaption:	Centering key b 20
	Tool adaption:	Sq. 25
	Coolant:	IC/Ext
	Pressure max [bar]:	100
8 249 14 000	Holder with square seat 12 mm	
	Shank type:	BMT
	Machine adaption:	Centering key b 20
	Tool adaption:	Sq. 12
	Coolant:	EXT
	Please note:	Special
	Center distance [mm]:	55
8 249 15 001	Double collet chuck holder ER 25	
	Weight [kg]:	4.240
	Notation:	180° reversible
	Shank type:	BMT
	Machine adaption:	Centering key b 20
	Tool adaption:	ER 25
	Coolant:	IC/Ext
	Center distance [mm]:	75
8 249 16 000	Double collet chuck holder ER 32	
	Weight [kg]:	4.000
	Notation:	180° reversible
	Shank type:	BMT
	Machine adaption:	Centering key b 20
	Tool adaption:	ER 32
	Coolant:	IC/Ext
	Center distance [mm]:	75
8 249 16 009	Double tool holder HT 4	
	Weight [kg]:	3.660
	Notation:	180° reversible
	Shank type:	BMT
	Machine adaption:	Centering key b 20
	Tool adaption:	HT 4
	Coolant:	IC/Ext

Part-#	Name	
	Center distance [mm]:	75
8 249 17 001	Double collet chuck holder ER 40	
	Notation:	180° reversible
	Shank type:	BMT
	Machine adaption:	Centering key b 20
	Tool adaption:	ER 40
	Coolant:	IC/Ext
	Center distance [mm]:	75
8 249 17 003	Double boring bar holder Ø 25	
	Weight [kg]:	3.770
	Notation:	180° reversible
	Shank type:	BMT
	Machine adaption:	Centering key b 20
	Tool adaption:	Ø 25
	Coolant:	IC/Ext
	Please note:	Housing rigid
	Center distance [mm]:	75
8 249 18 003	Adapter for sensor m&h IRP 40.01	
	Weight [kg]:	5.230
	Notation:	180° reversible
	Shank type:	BMT
	Machine adaption:	Centering key b 20
	Tool adaption:	Ø 32
	Coolant:	no
	Center distance [mm]:	112
8 249 18 008	Double boring bar holder Ø 32	
	Weight [kg]:	3.800
	Notation:	180° reversible
	Shank type:	BMT
	Machine adaption:	Centering key b 20
	Tool adaption:	Ø 32
	Coolant:	IC/Ext
	Please note:	Housing rigid
	Center distance [mm]:	75
8 251 11 000	Double turning holder sq. 20	
	Weight [kg]:	2.250
	Shank type:	BMT
	Machine adaption:	Centering key b 20
	Tool adaption:	Sq. 20
	Coolant:	EXT
8 251 11 003	Double turning holder sq. 20	
	Weight [kg]:	2.420
	Notation:	180° reversible
	Employment for:	right cutting tools
	Shank type:	BMT
	Machine adaption:	Centering key b 20
	Tool adaption:	Sq. 20
	Coolant:	EXT

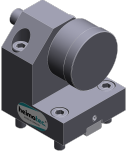

Part-#	Name	
8 251 11 007	Double turning holder sq. 3/4"	
	Weight [kg]:	2.390
	Notation:	180° reversible
	Employment for:	right cutting tools
	Shank type:	BMT
	Machine adaption:	Centering key b 20
	Tool adaption:	Sq. 3/4" (19,05mm)
		Sq. 3/4" (19,05mm)
	Coolant:	EXT
8 251 12 006	Double turning holder sq. 25	
	Weight [kg]:	4.910
	Notation:	180° reversible
	Employment for:	right cutting tools
	Shank type:	BMT
	Machine adaption:	Centering key b 20
	Tool adaption:	Sq. 25
	Coolant:	EXT
8 251 13 000	Combi multiple holder 8x sq. 16	
	Shank type:	BMT
8 251 15 048	Combi double turning holder sq. 25 IC	
	Notation:	180° reversible
	Employment for:	Main- and sub spindle
	Shank type:	BMT
	Machine adaption:	Centering key b 20
	Tool adaption:	Sq. 25
		Sq. 25
		Sq. 25
		Sq. 25
	Coolant:	IC/Ext
	Pressure max [bar]:	100
	Please note:	Key rail
8 253 15 014	Double boring bar holder Ø 16	
	Weight [kg]:	5.500
	Notation:	180° reversible
	Version:	Special
	Shank type:	BMT
	Machine adaption:	Centering key b 20
	Tool adaption:	Ø 16
		Ø 16
	Coolant:	IC/Ext
	Center distance [mm]:	56/99
8 253 16 016	Double boring bar holder Ø 20	
	Weight [kg]:	5.360
	Notation:	180° reversible
	Version:	Special
	Shank type:	BMT
	Machine adaption:	Centering key b 20
	Tool adaption:	Ø 20
		Ø 20
	Coolant:	IC/Ext
	Center distance [mm]:	56/99

Part-#	Name	
8 253 17 004	Double boring bar holder Ø 25	
	Weight [kg]:	2.840
	Shank type:	BMT
	Machine adaption:	Centering key b 20
	Tool adaption:	Ø 25
	Coolant:	IC/Ext
	Center distance [mm]:	43/88
8 253 17 010	Double boring bar holder Ø 25 - W 1418-2	
	Weight [kg]:	3.080
	Notation:	180° reversible
	Shank type:	BMT
	Machine adaption:	Centering key b 20
	Tool adaption:	Ø 25
		Ø 25
	Coolant:	IC/Ext
	Center distance [mm]:	56/99
8 253 17 012	Multiple boring bar holder 2x Ø 25	
	Weight [kg]:	3.980
	Notation:	offset
	Shank type:	BMT
	Tool adaption:	Ø 25
		Ø 25 - 30°
	Coolant:	IC/Ext
	Center distance [mm]:	75
8 253 17 051	Multiple boring bar holder Ø 1"	
	Weight [kg]:	3.060
	Notation:	180° reversible
	Shank type:	BMT
	Machine adaption:	Centering key b 20
	Tool adaption:	Ø 1" (25,4mm)
		Ø 1" (25,4mm)
	Coolant:	IC/Ext
	Center distance [mm]:	56/99
8 253 17 090	Double boring bar holder Ø 25	
	Weight [kg]:	2.970
	Notation:	180° reversible
	Version:	offset
	Shank type:	BMT
	Machine adaption:	Centering key b 20
	Tool adaption:	Ø 25
		Ø 25
	Coolant:	IC/Ext
	Center distance [mm]:	56/99
8 253 18 000	Double boring bar holder Ø 32	
	Weight [kg]:	4.640
	Shank type:	BMT
	Machine adaption:	Centering key b 20
	Tool adaption:	Ø 32
	Coolant:	IC/Ext
	Center distance [mm]:	56/99

Part-#	Name	
8 253 18 017	Double boring bar holder Ø 32	
	Weight [kg]:	4.730
	Notation:	180° reversible
	Version:	Special
	Shank type:	BMT
	Machine adaption:	Centering key b 20
	Tool adaption:	Ø 32
		Ø 32
	Coolant:	IC/Ext
	Center distance [mm]:	56/99
8 259 15 001	Multiple holder C 3 and sq. 20	
	Weight [kg]:	3.960
	Notation:	180° reversible
	Shank type:	BMT
	Machine adaption:	Centering key b 20
	Tool adaption:	Sq. 20
		heimatec Capto(TM) C 3
	Coolant:	IC/Ext
	Center distance [mm]:	55
8 259 19 000	Combi multiple holder 6x sq. 20	
	Shank type:	BMT
	Tool adaption:	Sq. 20
		Sq. 20
		Sq. 20
		Sq. 20
		Sq. 20
		Sq. 20
	Coolant:	IC/Ext
8 259 19 002	Multiple holder ER 25 and sq. 20	
	Weight [kg]:	3.620
	Notation:	180° reversible
	Shank type:	BMT
	Machine adaption:	Centering key b 20
	Tool adaption:	Sq. 20
		ER 25
	Coolant:	IC/Ext
	Center distance [mm]:	55
8 261 18 003	Tool holder for centering insert	
	Weight [kg]:	5.960
	Notation:	180° reversible
	Shank type:	BMT
	Machine adaption:	Centering key b 20
	Tool adaption:	Ø 32
	Coolant:	EXT
	Please note:	Price without centering point
	Center distance [mm]:	55 or 75
8 261 18 004	Tool holder for centering insert	
	Notation:	180° reversible
	Version:	Special
	Shank type:	BMT
	Machine adaption:	Centering key b 20
	Tool adaption:	Ø 34
	Coolant:	EXT

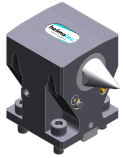
Part-#	Name	
	Please note:	Price without centering point
	Center distance [mm]:	55
8 262 19 001	Stock stop Ø 60 offset	
	Weight [kg]:	3.440
	Notation:	rotating
	Shank type:	BMT
	Machine adaption:	Centering key b 20
	Coolant:	no
	Please note:	Length adjustable
	Center distance [mm]:	75
8 263 18 000	Cutter holder with rotating spring-loaded centering point	
	Weight [kg]:	4.810
	Notation:	180° reversible
	Version:	Special
	Shank type:	BMT
	Machine adaption:	Centering key b 20
	Rotation max [1/min]:	6000
	Coolant:	EXT
	Please note:	Taper roller bearings
	Center distance [mm]:	75
8 263 19 002	Tool holder with rotating centering point	
	Weight [kg]:	4.280
	Notation:	180° reversible
	Shank type:	BMT
	Machine adaption:	Centering key b 20
	Rotation max [1/min]:	6000
	Coolant:	EXT
	Please note:	Taper roller bearings
	Center distance [mm]:	75
8 263 19 003	Tool holder with rotating centering point	
	Weight [kg]:	6.000
	Notation:	180° reversible
	Version:	Special
	Shank type:	BMT
	Machine adaption:	Centering key b 20
	Coolant:	EXT
	Please note:	Taper roller bearings
	Center distance [mm]:	100
8 263 19 007	Tool holder with rotating centering point	
	Weight [kg]:	4.375
	Notation:	180° reversible
	Shank type:	BMT
	Machine adaption:	Centering key b 20
	Rotation max [1/min]:	6000
	Coolant:	EXT
	Please note:	Taper roller bearings
	Center distance [mm]:	75

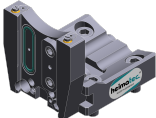
Part-#	Name	
8 263 19 008	Tool holder with rotating centering point	
	Weight [kg]:	6.140
	Notation:	180° reversible
	Version:	Special
	Shank type:	BMT
	Machine adaption:	Centering key b 20
	Rotation max [1/min]:	6000
	Coolant:	EXT
	Please note:	Taper roller bearings
	Center distance [mm]:	100
8 263 19 012	Tool holder with rotating centering point	
	Weight [kg]:	4.340
	Notation:	180° reversible
	Version:	Special
	Shank type:	BMT
	Machine adaption:	Centering key b 20
	Rotation max [1/min]:	6000
	Coolant:	EXT
	Please note:	Taper roller bearings
	Center distance [mm]:	75
8 263 19 013	Tool holder with rotating centering point	
	Weight [kg]:	4.290
	Notation:	180° reversible
	Version:	Special
	Shank type:	BMT
	Machine adaption:	Centering key b 20
	Rotation max [1/min]:	6000
	Coolant:	EXT
	Please note:	Taper roller bearings
	Center distance [mm]:	75
8 263 19 014	Tool holder with rotating centering point	
	Weight [kg]:	4.090
	Notation:	180° reversible
	Version:	Special
	Shank type:	BMT
	Machine adaption:	Centering key b 20
	Rotation max [1/min]:	6000
	Coolant:	EXT
	Please note:	Taper roller bearings
	Center distance [mm]:	75
8 263 19 021	Tool holder with rotating centering point	
	Notation:	180° reversible
	Version:	Special
	Shank type:	BMT
	Machine adaption:	Centering key b 20
	Rotation max [1/min]:	6000
	Coolant:	EXT
	Please note:	Taper roller bearings
	Center distance [mm]:	75

Part-#	Name	
8 263 19 025	Tool holder with rotating centering point	
	Weight [kg]:	4.370
	Notation:	180° reversible
	Shank type:	BMT
	Machine adaption:	Centering key b 20
	Rotation max [1/min]:	6000
	Coolant:	EXT
	Please note:	Taper roller bearings
	Center distance [mm]:	75
8 320 12 010	Cut-off holder, height adjustable SH 26 IC	
	Weight [kg]:	1.680
	Notation:	180° reversible
	Shank type:	BMT
	Machine adaption:	Centering key b 20
	Tool adaption:	Clampshaft SH 26
	Coolant:	IC/Ext
	Pressure max [bar]:	70
8 320 12 020	Cut-off holder, height adjustable SH 26 IC	
	Notation:	180° reversible
	Shank type:	BMT
	Machine adaption:	Centering key b 20
	Tool adaption:	Clampshaft SH 26
	Coolant:	IC/Ext
	Pressure max [bar]:	70
	Please note:	with offset cut-off tool holder
8 320 13 002	Cut-off holder, height adjustable SH 32 IC	
	Weight [kg]:	1.570
	Notation:	180° reversible
	Shank type:	BMT
	Machine adaption:	Centering key b 20
	Tool adaption:	Clampshaft SH 32
	Coolant:	IC/Ext
	Pressure max [bar]:	70
8 320 13 010	Cut-off holder, height adjustable SH 32 IC	
	Weight [kg]:	1.730
	Notation:	180° reversible
	Shank type:	BMT
	Machine adaption:	Centering key b 20
	Tool adaption:	Clampshaft SH 32
	Coolant:	IC/Ext
	Pressure max [bar]:	70
	Please note:	Clampshaft internal
8 320 13 015	Cut-off holder, height adjustable SH 32 IC	
	Weight [kg]:	1.830
	Notation:	180° reversible
	Shank type:	BMT
	Machine adaption:	Centering key b 20
	Tool adaption:	Clampshaft SH 32
	Coolant:	IC/Ext
	Pressure max [bar]:	70
	Please note:	with offset cut-off tool holder

Part-#	Name	
8 782 16 001	Spacer plate 20mm Shank type: Machine adaption: Tool adaption: Coolant: Please note:	BMT Centering key b 20 Centering key slot b 20 EXT Plate without fastening screws !
8 782 16 003	Spacer plate 25mm Shank type: Machine adaption: Tool adaption: Coolant: Please note:	BMT Centering key b 20 Centering key slot b 20 EXT Plate without fastening screws !

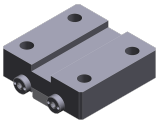

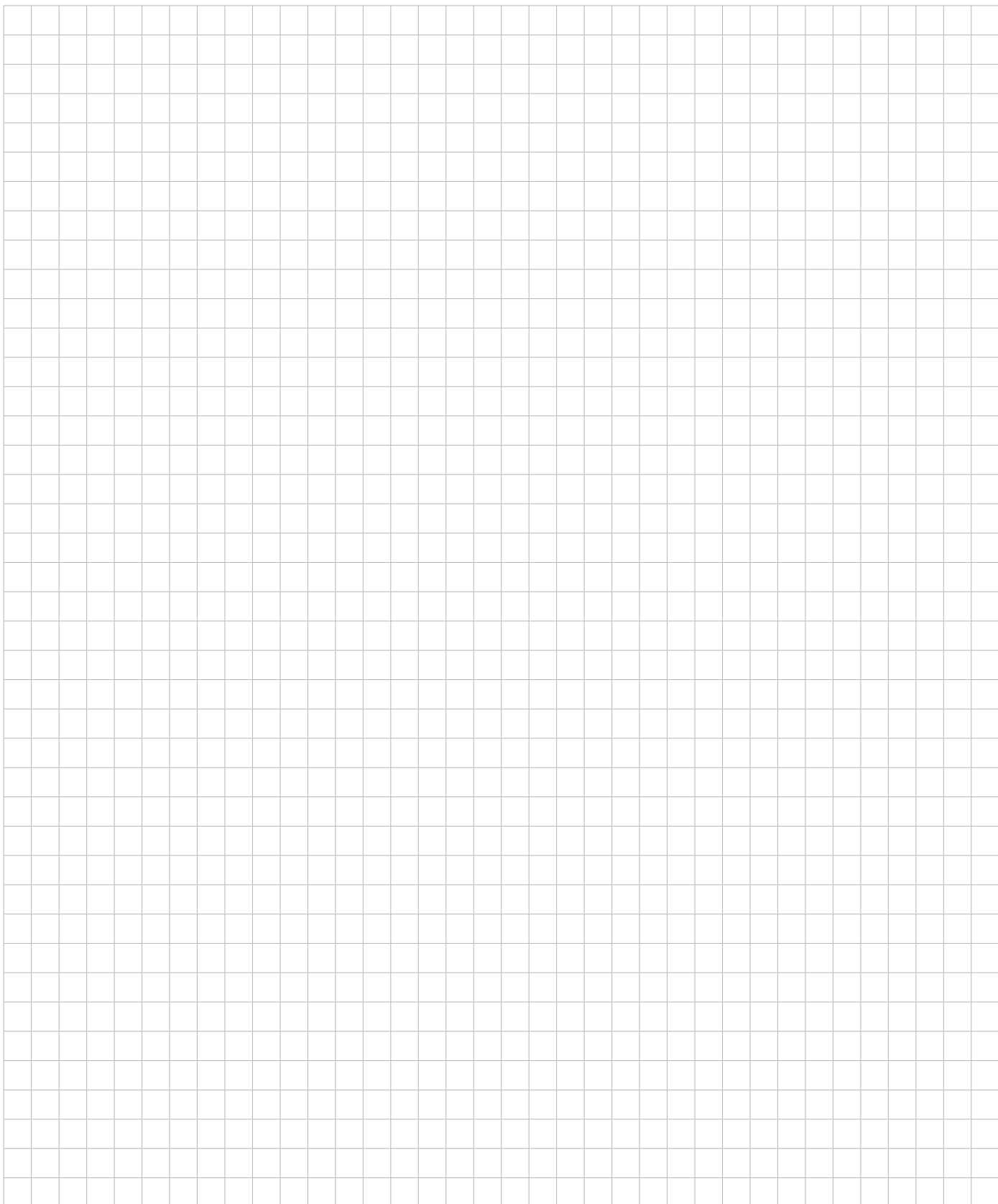



heimatec.u-tec®

heimatec.com

Products / Tool change systems /
u-tec® Tool-changing system



versions see catalog



heimatec.easy-quick

heimatec.com

Products / Tool change systems /
easy-quick HT quick-changing system



versions see catalog



heimatec.Capto™

heimatec.com

Products / Tool change systems /
heimatec.Capto™ quick-changing system



versions see catalog

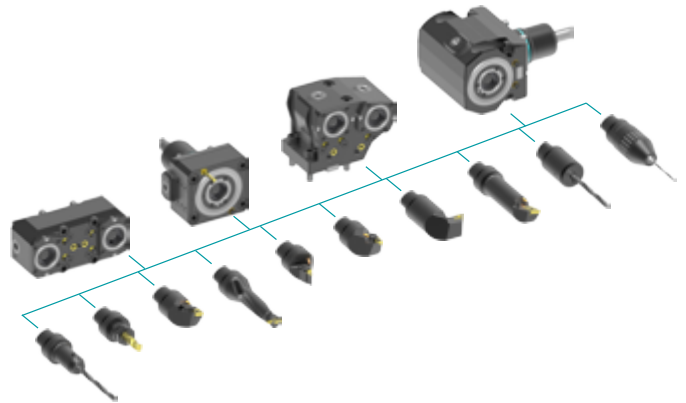

heimatec.accessories

heimatec.com

Products / Accessories



versions see catalog





● heimatec overseas branches

○ global representations of heimatec

heimatec[®]

heimatec GmbH
Präzisionswerkzeuge
Carl-Benz-Str. 4
77871 Renchen
Germany

T +49 7843 9466 0
www.heimatec.com
info@heimatec.com

Please find the contact details of our worldwide trading partners on our website:
<https://heimatec.com/business-partners>