

Nakamura  
**WT- 20-II**



# High-tech from heimatec - heimatec - Tools and systems for productive turning and milling

heimatec belongs to the international technology and quality leaders for precision tools and specializes in the development and production of high-precision static and live tools for all CNC lathes, CNC turn-/mill machines and CNC machining centers.

The range of products\* spans from static BMT and VDI tool holders, live tools up to highly complex customer-specific individual solutions. heimatec, headquartered in Renchen, has a own subsidiary in Asia and India and numerous representatives as well as trading partners all over the world.

## \*OUR PRODCUTS

Static tool holders

Live tool units

Precision tools

Tools for turning and machining centres

Tools for swiss type lathes

Tool changing and uick-change systems

Tool systems for gear production

Digital tool management

This catalogue, including all its parts, is protected by copyright. Any use outside the restricted limitations of the Copyright Act without the consent of heimatec is inadmissible and liable to prosecution. This applies in particular to duplication, translation, microfilming and storage and processing in electronic systems.

**heimatec GmbH** reserves the right to make technical changes at any time without giving prior notice. This applies in particular to adjustments at any time to meet new or changed international standards, or in case of further developments of our products or manufacturing processes.

The current version of our General Terms and Conditions can be found on our website.



Part-#	Name	
<b>8 200 03 002</b>	<b>Cover plate</b>	
	Weight [kg]:	0.300
	Shank type:	BMT
<b>8 200 10 002</b>	<b>Tool blank</b>	
	Weight [kg]:	4.190
	Notation:	180° reversible
	Shank type:	BMT
	Machine adaption:	Centering key b 20
	Please note:	Housing rigid
<b>8 202 10 006</b>	<b>Basic holder longitudinal seat FN 12</b>	
	Weight [kg]:	0.960
	Notation:	180° reversible
	Shank type:	BMT
	Machine adaption:	Centering key b 20
	Tool adaption:	Interface FN 12
	Coolant:	EXT
<b>8 209 10 000</b>	<b>Tool blank</b>	
	Weight [kg]:	4.580
	Shank type:	BMT
	Machine adaption:	Centering key b 20
	Coolant:	EXT
<b>8 209 11 000</b>	<b>Adapter for VDI 20</b>	
	Shank type:	BMT
	Machine adaption:	Centering key b 20
	Tool adaption:	DIN 69880 - 20
	Coolant:	EXT
	Center distance [mm]:	55
<b>8 209 12 000</b>	<b>Adapter for VDI 30</b>	
	Weight [kg]:	2.750
	Employment for:	Outside operation
	Shank type:	BMT
	Machine adaption:	Centering key b 20
	Tool adaption:	DIN 69880 - 30
	Coolant:	EXT
	Center distance [mm]:	35
<b>8 209 12 001</b>	<b>Adapter for VDI 30</b>	
	Weight [kg]:	3.140
	Employment for:	Inside operation
	Shank type:	BMT
	Machine adaption:	Centering key b 20
	Tool adaption:	DIN 69880 - 30
	Coolant:	EXT
	Center distance [mm]:	65

Part-#	Name	
<b>8 209 14 002</b>	<b>Adapter for VDI 40</b>	
	Weight [kg]:	2.720
	Shank type:	BMT
	Machine adaption:	Centering key b 20
	Tool adaption:	DIN 69880 - 40
	Coolant:	EXT
	Center distance [mm]:	35
<b>8 209 14 003</b>	<b>Adapter for VDI 40 offset</b>	
	Shank type:	BMT
	Machine adaption:	Centering key b 20
	Tool adaption:	DIN 69880 - 40
	Coolant:	EXT
	Center distance [mm]:	65
<b>8 209 19 000</b>	<b>Adapter 45 ° for Ecoroll WKT EG5-1-SL00</b>	
	Weight [kg]:	2.590
	Notation:	180° reversible
	Shank type:	BMT
	Machine adaption:	Centering key b 20
	Coolant:	EXT
<b>8 209 58 000</b>	<b>Adapter for sensor m&amp;h RWP 38.41</b>	
	Notation:	180° reversible
	Shank size [mm]:	55.00
	Shank type:	BMT
	Tool adaption:	Ø 32
	Coolant:	no
<b>8 209 58 001</b>	<b>Adapter for sensor m&amp;h IRP 40.01</b>	
	Weight [kg]:	1.340
	Notation:	180° reversible
	Shank size [mm]:	55.00
	Shank type:	BMT
	Tool adaption:	Ø 32
	Coolant:	no
<b>8 209 58 002</b>	<b>Adapter for sensor m&amp;h IRP 40.02</b>	
	Weight [kg]:	1.520
	Notation:	180° reversible
	Shank size [mm]:	55.00
	Shank type:	BMT
	Coolant:	no
<b>8 209 58 003</b>	<b>Adapter for sensor Renishaw RLP</b>	
	Weight [kg]:	1.700
	Notation:	180° reversible
	Shank size [mm]:	55.00
	Shank type:	BMT
	Coolant:	no

Part-#	Name	
<b>8 224 11 002</b>	<b>Turning holder sq. 20</b>	
	Weight [kg]:	2.420
	Employment for:	right cutting tools
	Shank type:	BMT
	Machine adaption:	Centering key b 20
	Tool adaption:	Sq. 20
	Coolant:	EXT
<b>8 224 11 003</b>	<b>Cut-off holder sq. 20</b>	
	Weight [kg]:	1.040
	Employment for:	right cutting tools
	Version:	Edge on side of turret
	Shank type:	BMT
	Machine adaption:	Centering key b 20
	Tool adaption:	Sq. 20
	Coolant:	EXT
<b>8 224 11 005</b>	<b>Cut-off holder sq. 20</b>	
	Weight [kg]:	1.100
	Employment for:	left cutting tools
	Version:	Edge on center of turret
	Shank type:	BMT
	Machine adaption:	Centering key b 20
	Tool adaption:	Sq. 20
	Coolant:	EXT
<b>8 224 11 016</b>	<b>Cut-off holder sq. 3/4" R 1441</b>	
	Weight [kg]:	1.110
	Employment for:	right cutting tools
	Version:	Edge on side of turret
	Shank type:	BMT
	Machine adaption:	Centering key b 20
	Tool adaption:	Sq. 3/4" (19,05mm)
	Coolant:	EXT
<b>8 224 11 022</b>	<b>Cut-off holder sq. 20</b>	
	Weight [kg]:	1.350
	Employment for:	right cutting tools
	Version:	Edge on side of turret
	Shank type:	BMT
	Machine adaption:	Centering key b 20
	Tool adaption:	Sq. 20
	Coolant:	EXT
<b>8 224 12 005</b>	<b>Cut-off holder sq. 25</b>	
	Weight [kg]:	1.480
	Shank type:	BMT
	Machine adaption:	Centering key b 20
	Tool adaption:	Sq. 25
	Coolant:	EXT

Part-#	Name	
<b>8 224 12 006</b>	<b>Cut-off holder sq. 25</b>	
	Weight [kg]:	1.480
	Employment for:	left cutting tools
	Version:	Edge on center of turret
	Shank type:	BMT
	Machine adaption:	Centering key b 20
	Tool adaption:	Sq. 25
	Coolant:	EXT
<b>8 224 13 004</b>	<b>Cut-off holder SH 32</b>	
	Weight [kg]:	1.000
	Employment for:	Cut-off tool 32
	Version:	Clampshaft on turret center
	Shank type:	BMT
	Machine adaption:	Centering key b 20
	Tool adaption:	Clampshaft SH 32
	Coolant:	EXT
<b>8 224 13 007</b>	<b>Cut-off holder SH 32</b>	
	Weight [kg]:	1.190
	Employment for:	Cut-off tool 32
	Version:	Clampshaft on turret side
	Shank type:	BMT
	Machine adaption:	Centering key b 20
	Tool adaption:	Clampshaft SH 32
	Coolant:	EXT
<b>8 224 13 013</b>	<b>Cut-off holder SH 32</b>	
	Weight [kg]:	1.480
	Employment for:	Cut-off tool 32
	Version:	Clampshaft on turret side
	Shank type:	BMT
	Machine adaption:	Centering key b 20
	Tool adaption:	Clampshaft SH 32
	Coolant:	EXT
	Please note:	Special
<b>8 224 13 021</b>	<b>Cut-off holder SH 32 IC</b>	
	Weight [kg]:	1.030
	Employment for:	Cut-off tool 32
	Version:	Clampshaft on turret center
	Shank type:	BMT
	Machine adaption:	Centering key b 20
	Tool adaption:	Clampshaft SH 32
	Coolant:	IC/Ext
<b>8 224 14 000</b>	<b>Universal turning holder sq. 20</b>	
	Weight [kg]:	1.730
	Notation:	180° reversible
	Shank type:	BMT
	Machine adaption:	Centering key b 20
	Tool adaption:	Sq. 20
		Sq. 20
	Coolant:	EXT
	Please note:	with spacer strip



Part-#	Name	
<b>8 224 14 016</b>	<b>Universal turning holder sq. 20 IC</b>	
	Weight [kg]:	2.950
	Notation:	180° reversible
	Shank type:	BMT
	Machine adaption:	Centering key b 20
	Tool adaption:	Sq. 20
	Coolant:	IC/Ext
	Pressure max [bar]:	100
	Please note:	Key rail
<b>8 224 15 002</b>	<b>Universal turning holder sq. 25/20</b>	
	Weight [kg]:	2.800
	Notation:	180° reversible
	Shank type:	BMT
	Machine adaption:	Centering key b 20
	Tool adaption:	Sq. 25
		Sq. 25
	Coolant:	EXT
	Please note:	With spacer strip for sq. 20
<b>8 224 15 012</b>	<b>Universal turning holder sq. 1"</b>	
	Weight [kg]:	2.720
	Shank type:	BMT
	Machine adaption:	Centering key b 20
	Tool adaption:	Sq. 1" (25,4mm)
		Sq. 1" (25,4mm)
	Coolant:	EXT
<b>8 224 15 046</b>	<b>Universal turning holder sq. 25/20</b>	
	Weight [kg]:	5.520
	Shank type:	BMT
	Machine adaption:	Centering key b 20
	Tool adaption:	Sq. 25
		Sq. 25
	Coolant:	EXT
	Please note:	Check applicability! with spacer strip for
<b>8 224 15 062</b>	<b>Universal turning holder sq. 25 IC</b>	
	Weight [kg]:	3.100
	Shank type:	BMT
	Machine adaption:	Centering key b 20
	Tool adaption:	Sq. 25
		Sq. 25
	Coolant:	IC/Ext
	Pressure max [bar]:	100
	Please note:	Key rail
<b>8 224 15 063</b>	<b>Universal turning holder sq. 1" IC</b>	
	Weight [kg]:	3.100
	Shank type:	BMT
	Machine adaption:	Centering key b 20
	Tool adaption:	Sq. 1" (25,4mm)
		Sq. 1" (25,4mm)
	Coolant:	IC/Ext
	Pressure max [bar]:	100
	Please note:	Key rail



Part-#	Name	
<b>8 225 11 002</b>	<b>Cut-off holder sq. 20 R 1432</b>	
	Weight [kg]:	1.120
	Employment for:	left cutting tools
	Version:	Edge on side of turret
	Shank type:	BMT
	Machine adaption:	Centering key b 20
	Tool adaption:	Sq. 20
	Coolant:	EXT
<b>8 225 11 005</b>	<b>Cut-off holder sq. 20</b>	
	Weight [kg]:	1.170
	Employment for:	right cutting tools
	Version:	Edge on center of turret
	Shank type:	BMT
	Machine adaption:	Centering key b 20
	Tool adaption:	Sq. 20
	Coolant:	EXT
<b>8 225 11 009</b>	<b>Cut-off holder sq. 3/4" R 1442</b>	
	Weight [kg]:	1.110
	Employment for:	left cutting tools
	Version:	Edge on side of turret
	Shank type:	BMT
	Machine adaption:	Centering key b 20
	Tool adaption:	Sq. 3/4" (19,05mm)
	Coolant:	EXT
<b>8 225 11 012</b>	<b>Cut-off holder sq. 3/4"</b>	
	Weight [kg]:	1.200
	Employment for:	right cutting tools
	Version:	Edge on center of turret
	Shank type:	BMT
	Machine adaption:	Centering key b 20
	Tool adaption:	Sq. 3/4" (19,05mm)
	Coolant:	EXT
<b>8 240 14 017</b>	<b>Boring bar holder Ø 12 - slotted</b>	
	Weight [kg]:	2.900
	Notation:	180° reversible
	Version:	slotted
	Shank type:	BMT
	Machine adaption:	Centering key b 20
	Tool adaption:	Ø 12
	Coolant:	EXT
	Pressure max [bar]:	100
	Center distance [mm]:	75
<b>8 240 14 022</b>	<b>Boring bar holder Ø 10 - slotted</b>	
	Weight [kg]:	2.900
	Notation:	180° reversible
	Version:	slotted
	Shank type:	BMT
	Machine adaption:	Centering key b 20
	Tool adaption:	Ø 10
	Coolant:	EXT
	Pressure max [bar]:	100
	Center distance [mm]:	75

Part-#	Name	
<b>8 240 15 002</b>	<b>Tool holder ABS 50 IC/Ext</b>	
	Weight [kg]:	3.560
	Notation:	offset
	Shank type:	BMT
	Machine adaption:	Centering key b 20
	Tool adaption:	ABS 50
	Coolant:	IC/Ext
	Center distance [mm]:	75
<b>8 240 15 003</b>	<b>Boring bar holder Ø 16 DIN 1835 E</b>	
	Weight [kg]:	3.020
	Shank type:	BMT
	Machine adaption:	Centering key b 20
	Tool adaption:	Whistle-Notch (DIN 1835 E) 16
	Coolant:	IC/Ext
	Center distance [mm]:	75
<b>8 240 15 004</b>	<b>Tool holder C 3 IC</b>	
	Weight [kg]:	3.580
	Notation:	180° reversible; offset
	Shank type:	BMT
	Machine adaption:	Centering key b 20
	Tool adaption:	heimatec Capto(TM) C 3
	Coolant:	IC
	Center distance [mm]:	75
<b>8 240 15 005</b>	<b>Tool holder C 3 offset</b>	
	Version:	Special
	Shank type:	BMT
	Machine adaption:	Centering key b 20
	Tool adaption:	heimatec Capto(TM) C 3
	Coolant:	IC/Ext
	Center distance [mm]:	75
<b>8 240 15 006</b>	<b>Collet chuck holder ER 25</b>	
	Weight [kg]:	3.520
	Notation:	180° reversible
	Shank type:	BMT
	Machine adaption:	Centering key b 20
	Tool adaption:	ER 25
	Coolant:	IC/Ext
	Please note:	Insert reversible
	Center distance [mm]:	75
<b>8 240 15 007</b>	<b>Insert drill holder 16 IC</b>	
	Weight [kg]:	4.540
	Notation:	180° reversible
	Shank type:	BMT
	Tool adaption:	Whistle-Notch (DIN 1835 E) 16
	Coolant:	IC
	Center distance [mm]:	75



Part-#	Name	
<b>8 240 15 019</b>	<b>Collet chuck holder ER 25 AX UT IC</b>	
	Weight [kg]:	3.380
	Notation:	180° reversible; offset
	Shank type:	BMT
	Machine adaption:	Centering key b 20
	Tool adaption:	ER 25 A - u-tec
	Coolant:	IC/Ext
	Center distance [mm]:	75
<b>8 240 15 039</b>	<b>Boring bar holder Ø 16 - slotted</b>	
	Weight [kg]:	3.000
	Notation:	180° reversible
	Shank type:	BMT
	Machine adaption:	Centering key b 20
	Tool adaption:	Ø 16
	Coolant:	EXT
	Center distance [mm]:	75
<b>8 240 16 001</b>	<b>Boring bar holder Ø 20 DIN 1835 E</b>	
	Weight [kg]:	2.960
	Shank type:	BMT
	Machine adaption:	Centering key b 20
	Tool adaption:	Whistle-Notch (DIN 1835 E) 20
	Coolant:	IC
	Center distance [mm]:	75
<b>8 240 16 004</b>	<b>Tool holder HT 4 IC</b>	
	Weight [kg]:	2.890
	Notation:	180° reversible; offset
	Shank type:	BMT
	Machine adaption:	Centering key b 20
	Tool adaption:	HT 4
	Coolant:	IC/Ext
	Center distance [mm]:	75
<b>8 240 16 005</b>	<b>Boring bar holder Ø 24</b>	
	Notation:	180° reversible
	Version:	Special
	Shank type:	BMT
	Machine adaption:	Centering key b 20
	Tool adaption:	Ø 24
	Coolant:	IC/Ext
	Please note:	Housing rigid
	Center distance [mm]:	75
<b>8 240 16 006</b>	<b>Tool holder HT 4 IC</b>	
	Weight [kg]:	3.340
	Notation:	offset
	Version:	Special
	Shank type:	BMT
	Machine adaption:	Centering key b 20
	Tool adaption:	HT 4
	Coolant:	IC/Ext
	Center distance [mm]:	75

Part-#	Name	
<b>8 240 16 008</b>	<b>Collet chuck holder ER 32</b>	
	Weight [kg]:	3.200
	Notation:	180° reversible
	Shank type:	BMT
	Machine adaption:	Centering key b 20
	Tool adaption:	ER 32
	Coolant:	IC/Ext
	Please note:	Insert reversible
	Center distance [mm]:	75
<b>8 240 16 009</b>	<b>Insert drill holder 20 IC</b>	
	Weight [kg]:	4.480
	Notation:	180° reversible
	Shank type:	BMT
	Tool adaption:	Whistle-Notch (DIN 1835 E) 20
	Coolant:	IC
	Center distance [mm]:	75
<b>8 240 16 020</b>	<b>Tool holder HT 4 IC</b>	
	Weight [kg]:	5.900
	Notation:	offset; 180° reversible
	Version:	Special
	Shank type:	BMT
	Machine adaption:	Centering key b 20
	Tool adaption:	HT 4
	Coolant:	IC/Ext
	Center distance [mm]:	75
<b>8 240 16 030</b>	<b>Boring bar holder Ø 20</b>	
	Weight [kg]:	3.940
	Notation:	180° reversible
	Shank type:	BMT
	Machine adaption:	Centering key b 20
	Tool adaption:	Ø 20
	Coolant:	IC/Ext
	Please note:	Housing rigid
	Center distance [mm]:	75
<b>8 240 16 034</b>	<b>Collet chuck holder ER 32</b>	
	Weight [kg]:	3.060
	Notation:	180° reversible; offset
	Shank type:	BMT
	Machine adaption:	Centering key b 20
	Tool adaption:	ER 32
	Coolant:	IC/Ext
	Center distance [mm]:	75
<b>8 240 16 040</b>	<b>Tool holder C 4 IC</b>	
	Weight [kg]:	3.130
	Notation:	180° reversible
	Version:	offset; right
	Shank type:	BMT
	Machine adaption:	Centering key b 20
	Tool adaption:	heimatec Capto(TM) C 4
	Coolant:	IC/Ext
	Please note:	Check applicability; note tool length!
	Center distance [mm]:	75

Part-#	Name	
<b>8 240 16 045</b>	<b>Tool holder C 4 IC</b>	
	Weight [kg]:	2.960
	Notation:	180° reversible
	Version:	offset; right
	Shank type:	BMT
	Machine adaption:	Centering key b 20
	Tool adaption:	heimatec Capto(TM) C 4
	Coolant:	IC
	Please note:	Check applicability; note tool length!
	Center distance [mm]:	75
<b>8 240 16 046</b>	<b>Tool holder C 4 IC</b>	
	Weight [kg]:	3.480
	Notation:	180° reversible
	Version:	right
	Shank type:	BMT
	Machine adaption:	Centering key b 20
	Tool adaption:	heimatec Capto(TM) C 4
	Coolant:	IC
	Please note:	Check applicability; note tool length!
	Center distance [mm]:	75
<b>8 240 16 051</b>	<b>Tool holder C 4 IC</b>	
	Weight [kg]:	3.430
	Notation:	180° reversible
	Version:	left
	Shank type:	BMT
	Machine adaption:	Centering key b 20
	Tool adaption:	heimatec Capto(TM) C 4
	Coolant:	IC
	Please note:	Check applicability; note tool length!
	Center distance [mm]:	75
<b>8 240 16 054</b>	<b>Tool holder C 4 IC</b>	
	Weight [kg]:	2.840
	Notation:	180° reversible
	Version:	left; special
	Shank type:	BMT
	Machine adaption:	Centering key b 20
	Tool adaption:	heimatec Capto(TM) C 4
	Coolant:	IC/Ext
	Please note:	Check applicability; note tool length!
	Center distance [mm]:	40
<b>8 240 16 077</b>	<b>Boring bar holder Ø 20 - slotted</b>	
	Weight [kg]:	3.120
	Notation:	180° reversible
	Version:	slotted
	Shank type:	BMT
	Machine adaption:	Centering key b 20
	Tool adaption:	Ø 20
	Coolant:	EXT
	Pressure max [bar]:	100
	Center distance [mm]:	75



Part-#	Name	
8 240 17 005	<b>Boring bar holder Ø 25</b>	
		<p>Weight [kg]: 3.820            Notation: 180° reversible            Shank type: BMT            Machine adaption: Centering key b 20            Tool adaption: Ø 25            Coolant: IC/Ext            Please note: Housing rigid            Center distance [mm]: 75</p>
8 240 17 007	<b>Boring bar holder Ø 25</b>	
		<p>Weight [kg]: 2.320            Notation: 180° reversible            Version: offset            Shank type: BMT            Machine adaption: Centering key b 20            Tool adaption: Ø 25            Coolant: IC/Ext            Please note: Housing rigid            Center distance [mm]: 75</p>
8 240 17 008	<b>Boring bar holder Ø 25 DIN 1835 E</b>	
		<p>Weight [kg]: 3.210            Notation: offset; 180° reversible            Version: Special            Shank type: BMT            Machine adaption: Centering key b 20            Tool adaption: Whistle-Notch (DIN 1835 E) 25            Coolant: IC/Ext            Center distance [mm]: 75</p>
8 240 17 011	<b>Boring bar holder Ø 25,4 (1")</b>	
		<p>Weight [kg]: 3.800            Notation: 180° reversible            Shank type: BMT            Machine adaption: Centering key b 20            Tool adaption: Ø 1" (25,4mm)            Coolant: IC/Ext            Pressure max [bar]: 140            Please note: Housing rigid            Center distance [mm]: 75</p>
8 240 17 012	<b>Boring bar holder Ø 25</b>	
		<p>Weight [kg]: 5.920            Notation: 180° reversible            Shank type: BMT            Machine adaption: Centering key b 20            Tool adaption: Ø 25            Coolant: IC/Ext            Please note: Housing rigid            Center distance [mm]: 117,5</p>





Part-#	Name	
<b>8 240 17 016</b>	<b>Boring bar holder Ø 30</b>	
	Notation:	180° reversible
	Version:	Special
	Shank type:	BMT
	Machine adaption:	Centering key b 20
	Tool adaption:	Ø 30
	Coolant:	IC/Ext
	Please note:	Housing rigid
	Center distance [mm]:	75
<b>8 240 17 021</b>	<b>Collet chuck holder ER 40</b>	
	Weight [kg]:	3.710
	Notation:	180° reversible
	Shank type:	BMT
	Machine adaption:	Centering key b 20
	Tool adaption:	ER 40
	Coolant:	IC/Ext
	Please note:	Insert reversible
	Center distance [mm]:	75
<b>8 240 17 023</b>	<b>Insert drill holder 25 IC</b>	
	Weight [kg]:	4.380
	Notation:	180° reversible
	Shank type:	BMT
	Tool adaption:	Whistle-Notch (DIN 1835 E) 25
	Coolant:	IC
	Center distance [mm]:	75
<b>8 240 17 031</b>	<b>Boring bar holder Ø 30</b>	
	Notation:	180° reversible
	Version:	Special
	Shank type:	BMT
	Machine adaption:	Centering key b 20
	Tool adaption:	Ø 30
	Coolant:	EXT
	Center distance [mm]:	112
<b>8 240 17 032</b>	<b>Boring bar holder Ø 30</b>	
	Notation:	180° reversible
	Version:	Special
	Shank type:	BMT
	Machine adaption:	Centering key b 20
	Tool adaption:	Ø 30
	Coolant:	EXT
	Center distance [mm]:	105
<b>8 240 17 049</b>	<b>Boring bar holder Ø 1" offset</b>	
	Weight [kg]:	2.450
	Notation:	180° reversible
	Version:	offset
	Shank type:	BMT
	Machine adaption:	Centering key b 20
	Tool adaption:	Ø 1" (25,4mm)
	Coolant:	IC/Ext
	Please note:	Housing rigid
	Center distance [mm]:	75

Part-#	Name	
<b>8 240 17 061</b>	<b>Boring bar holder Ø 1"</b>	
	Weight [kg]:	2.300
	Shank type:	BMT
	Machine adaption:	Centering key b 20
	Tool adaption:	Ø 1" (25,4mm)
	Coolant:	IC/Ext
	Center distance [mm]:	55
<b>8 240 17 065</b>	<b>Boring bar holder Ø 25 - slotted</b>	
	Weight [kg]:	3.670
	Notation:	180° reversible
	Shank type:	BMT
	Machine adaption:	Centering key b 20
	Tool adaption:	Ø 25
	Coolant:	EXT
	Please note:	Housing rigid
	Center distance [mm]:	75
<b>8 240 17 078</b>	<b>Boring bar holder Ø 1 1/4" - slotted</b>	
	Weight [kg]:	3.440
	Notation:	180° reversible
	Shank type:	BMT
	Machine adaption:	Centering key b 20
	Tool adaption:	Ø 1 1/4" (31,75mm)
	Coolant:	EXT
	Please note:	Housing rigid
	Center distance [mm]:	75
<b>8 240 17 096</b>	<b>Tool holder C 5 IC</b>	
	Weight [kg]:	5.030
	Notation:	180° reversible
	Version:	right
	Shank type:	BMT
	Machine adaption:	Centering key b 20
	Tool adaption:	heimatec Capto(TM) C 5
	Coolant:	IC
	Please note:	Check applicability; note tool length!
	Center distance [mm]:	75
<b>8 240 17 106</b>	<b>Boring bar holder Ø 25</b>	
	Weight [kg]:	4.800
	Notation:	180° reversible
	Shank type:	BMT
	Machine adaption:	Centering key b 20
	Tool adaption:	Ø 25
	Coolant:	IC/Ext
	Please note:	Check applicability! housing rigid
	Center distance [mm]:	95
<b>8 240 17 114</b>	<b>Boring bar holder Ø 1"</b>	
	Weight [kg]:	4.760
	Notation:	180° reversible
	Shank type:	BMT
	Machine adaption:	Centering key b 20
	Tool adaption:	Ø 1" (25,4mm)
	Coolant:	IC/Ext
	Please note:	Check applicability! housing rigid

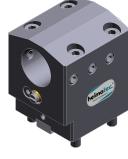
Part-#	Name	
	Center distance [mm]:	95
<b>8 240 17 115</b>	<b>Boring bar holder Ø 1 1/4"</b>	
	Weight [kg]:	4.620
	Notation:	180° reversible
	Shank type:	BMT
	Machine adaption:	Centering key b 20
	Tool adaption:	Ø 1 1/4" (31,75mm)
	Coolant:	IC/Ext
	Please note:	Check applicability! housing rigid
	Center distance [mm]:	95
<b>8 240 17 116</b>	<b>Boring bar holder Ø 1 1/4"</b>	
	Weight [kg]:	2.440
	Notation:	180° reversible
	Shank type:	BMT
	Machine adaption:	Centering key b 20
	Tool adaption:	Ø 1 1/4" (31,75mm)
	Coolant:	IC/Ext
	Please note:	Housing rigid
	Center distance [mm]:	75
<b>8 240 18 010</b>	<b>Boring bar holder Ø 32</b>	
	Weight [kg]:	3.640
	Notation:	180° reversible
	Shank type:	BMT
	Machine adaption:	Centering key b 20
	Tool adaption:	Ø 32
	Coolant:	IC/Ext
	Pressure max [bar]:	140
	Please note:	Housing rigid
	Center distance [mm]:	75
<b>8 240 18 011</b>	<b>Boring bar holder Ø 32</b>	
	Weight [kg]:	2.680
	Shank type:	BMT
	Machine adaption:	Centering key b 20
	Tool adaption:	Ø 32
	Coolant:	IC/Ext
	Center distance [mm]:	55
<b>8 240 18 012</b>	<b>Boring bar holder Ø 32 offset</b>	
	Weight [kg]:	2.420
	Notation:	180° reversible
	Version:	offset
	Shank type:	BMT
	Machine adaption:	Centering key b 20
	Tool adaption:	Ø 32
	Coolant:	IC/Ext
	Please note:	Housing rigid
	Center distance [mm]:	75

Part-#	Name	
<b>8 240 18 016</b>	<b>Boring bar holder Ø 32</b>	
	Weight [kg]:	4.370
	Notation:	180° reversible
	Shank type:	BMT
	Machine adaption:	Centering key b 20
	Tool adaption:	Ø 32
	Coolant:	IC/Ext
	Please note:	Housing rigid
	Center distance [mm]:	90
<b>8 240 18 021</b>	<b>Insert drill holder 32 IC</b>	
	Weight [kg]:	4.200
	Notation:	180° reversible
	Shank type:	BMT
	Tool adaption:	Whistle-Notch (DIN 1835 E) 32
	Coolant:	IC
	Center distance [mm]:	75
<b>8 240 18 033</b>	<b>Boring bar holder Ø 1 1/4"</b>	
	Weight [kg]:	3.630
	Notation:	180° reversible
	Shank type:	BMT
	Machine adaption:	Centering key b 20
	Tool adaption:	Ø 1 1/4" (31,75mm)
	Coolant:	IC/Ext
	Please note:	Housing rigid
	Center distance [mm]:	75
<b>8 240 18 037</b>	<b>Boring bar holder Ø 1 1/2"</b>	
	Weight [kg]:	4.540
	Notation:	180° reversible
	Shank type:	BMT
	Machine adaption:	Centering key b 20
	Tool adaption:	Ø 1 1/2" (38,1mm)
	Coolant:	IC/Ext
	Center distance [mm]:	75
<b>8 240 18 045</b>	<b>Boring bar holder Ø 32 offset</b>	
	Weight [kg]:	4.380
	Notation:	offset
	Shank type:	BMT
	Machine adaption:	Centering key b 20
	Tool adaption:	Ø 32
	Coolant:	IC/Ext
	Please note:	Front edge ø32- adapter on turret center
	Center distance [mm]:	75
<b>8 240 18 085</b>	<b>Boring bar holder Ø 32</b>	
	Weight [kg]:	4.605
	Notation:	180° reversible
	Shank type:	BMT
	Machine adaption:	Centering key b 20
	Tool adaption:	Ø 32
	Coolant:	IC/Ext
	Please note:	Check applicability! housing rigid
	Center distance [mm]:	95

Part-#	Name	
<b>8 240 18 088</b>	<b>Boring bar holder Ø 32 offset</b>	
	Weight [kg]:	4.200
	Notation:	offset
	Shank type:	BMT
	Machine adaption:	Centering key b 20
	Tool adaption:	Ø 32
	Coolant:	IC/Ext
	Please note:	Front edge ø32- adapter 20mm from turret center offset
	Center distance [mm]:	75
<b>8 240 18 098</b>	<b>Boring bar holder Ø 1 1/4"</b>	
	Notation:	180° reversible
	Shank type:	BMT
	Machine adaption:	Centering key b 20
	Tool adaption:	Ø 1 1/4" (31,75mm)
	Coolant:	IC/Ext
	Please note:	Check applicability!
	Center distance [mm]:	100
<b>8 240 18 102</b>	<b>Boring bar holder Ø 32 offset</b>	
	Weight [kg]:	6.780
	Notation:	180° reversible
	Version:	offset
	Shank type:	BMT
	Machine adaption:	Centering key b 20
	Tool adaption:	Ø 32
	Coolant:	IC
	Pressure max [bar]:	100
	Please note:	Check applicability! length
	Center distance [mm]:	80
<b>8 240 19 007</b>	<b>Boring bar holder Ø 40</b>	
	Weight [kg]:	4.260
	Notation:	offset; 180° reversible
	Shank type:	BMT
	Machine adaption:	Centering key b 20
	Tool adaption:	Ø 40
	Coolant:	IC/Ext
	Center distance [mm]:	75
<b>8 240 19 009</b>	<b>Boring bar holder Ø 40</b>	
	Weight [kg]:	4.480
	Notation:	180° reversible
	Shank type:	BMT
	Machine adaption:	Centering key b 20
	Tool adaption:	Ø 40
	Coolant:	IC/Ext
	Center distance [mm]:	75
<b>8 240 19 012</b>	<b>Boring bar holder Ø 40</b>	
	Weight [kg]:	3.460
	Shank type:	BMT
	Machine adaption:	Centering key b 20
	Tool adaption:	Ø 40
	Coolant:	IC/Ext
	Please note:	Special version

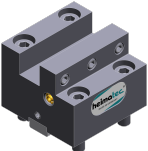
Part-#	Name	
	Center distance [mm]:	75
<b>8 240 19 025</b>	<b>Insert drill holder 40 IC</b>	
	Weight [kg]:	4.740
	Notation:	180° reversible
	Shank type:	BMT
	Tool adaption:	Whistle-Notch (DIN 1835 E) 40
	Coolant:	IC
	Center distance [mm]:	75
<b>8 240 19 105</b>	<b>Boring bar holder Ø 40</b>	
	Weight [kg]:	2.400
	Notation:	180° reversible
	Shank type:	BMT
	Machine adaption:	Centering key b 20
	Tool adaption:	Ø 40
	Coolant:	IC/Ext
	Center distance [mm]:	35
<b>8 240 19 139</b>	<b>Boring bar holder Ø 40</b>	
	Weight [kg]:	4.760
	Notation:	180° reversible
	Shank type:	BMT
	Machine adaption:	Centering key b 20
	Tool adaption:	Ø 40
	Coolant:	IC
	Please note:	Check applicability!
	Center distance [mm]:	100
<b>8 240 19 142</b>	<b>Boring bar holder Ø 40 offset</b>	
	Weight [kg]:	5.000
	Notation:	offset
	Shank type:	BMT
	Machine adaption:	Centering key b 20
	Tool adaption:	Ø 40
	Coolant:	IC/Ext
	Please note:	Front edge Ø40- adapter 60mm from turret center offset
	Center distance [mm]:	75
<b>8 240 19 143</b>	<b>Boring bar holder Ø 40 offset</b>	
	Weight [kg]:	4.000
	Notation:	offset
	Shank type:	BMT
	Machine adaption:	Centering key b 20
	Tool adaption:	Ø 40
	Coolant:	IC/Ext
	Please note:	Front edge Ø40- adapter 20mm from turret center offset
	Center distance [mm]:	75
<b>8 244 11 002</b>	<b>Facing holder sq. 20</b>	
	Weight [kg]:	2.340
	Notation:	180° reversible
	Shank type:	BMT
	Machine adaption:	Centering key b 20
	Tool adaption:	Sq. 20
	Coolant:	EXT

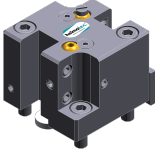

Part-#	Name	
<b>8 244 11 009</b>	<b>Facing holder sq. 20</b>	
	Weight [kg]:	4.090
	Notation:	180° reversible
	Version:	Special; extended version
	Shank type:	BMT
	Machine adaption:	Centering key b 20
	Tool adaption:	Sq. 20
	Coolant:	EXT
<b>8 244 12 005</b>	<b>Facing holder sq. 1"</b>	
	Weight [kg]:	3.570
	Shank type:	BMT
	Machine adaption:	Centering key b 20
	Tool adaption:	Sq. 1" (25,4mm)
	Coolant:	EXT
<b>8 244 12 027</b>	<b>Facing holder sq. 25 IC</b>	
	Weight [kg]:	3.640
	Shank type:	BMT
	Machine adaption:	Centering key b 20
	Tool adaption:	Sq. 25
	Coolant:	IC/Ext
	Pressure max [bar]:	100
<b>8 249 14 000</b>	<b>Holder with square seat 12 mm</b>	
	Shank type:	BMT
	Machine adaption:	Centering key b 20
	Tool adaption:	Sq. 12
	Coolant:	EXT
	Please note:	Special
	Center distance [mm]:	55
<b>8 249 15 001</b>	<b>Double collet chuck holder ER 25</b>	
	Weight [kg]:	4.240
	Notation:	180° reversible
	Shank type:	BMT
	Machine adaption:	Centering key b 20
	Tool adaption:	ER 25
	Coolant:	IC/Ext
	Center distance [mm]:	75
<b>8 249 16 000</b>	<b>Double collet chuck holder ER 32</b>	
	Weight [kg]:	4.000
	Notation:	180° reversible
	Shank type:	BMT
	Machine adaption:	Centering key b 20
	Tool adaption:	ER 32
	Coolant:	IC/Ext
	Center distance [mm]:	75
<b>8 249 16 009</b>	<b>Double tool holder HT 4</b>	
	Weight [kg]:	3.660
	Notation:	180° reversible
	Shank type:	BMT
	Machine adaption:	Centering key b 20
	Tool adaption:	HT 4
	Coolant:	IC/Ext

Part-#	Name	
	Center distance [mm]:	75
<b>8 249 17 001</b>	<b>Double collet chuck holder ER 40</b>	
	Notation:	180° reversible
	Shank type:	BMT
	Machine adaption:	Centering key b 20
	Tool adaption:	ER 40
	Coolant:	IC/Ext
	Center distance [mm]:	75
<b>8 249 17 003</b>	<b>Double boring bar holder Ø 25</b>	
	Weight [kg]:	3.770
	Notation:	180° reversible
	Shank type:	BMT
	Machine adaption:	Centering key b 20
	Tool adaption:	Ø 25
	Coolant:	IC/Ext
	Please note:	Housing rigid
	Center distance [mm]:	75
<b>8 249 18 003</b>	<b>Adapter for sensor m&amp;h IRP 40.01</b>	
	Weight [kg]:	5.230
	Notation:	180° reversible
	Shank type:	BMT
	Machine adaption:	Centering key b 20
	Tool adaption:	Ø 32
	Coolant:	no
	Center distance [mm]:	112
<b>8 249 18 008</b>	<b>Double boring bar holder Ø 32</b>	
	Weight [kg]:	3.800
	Notation:	180° reversible
	Shank type:	BMT
	Machine adaption:	Centering key b 20
	Tool adaption:	Ø 32
	Coolant:	IC/Ext
	Please note:	Housing rigid
	Center distance [mm]:	75
<b>8 251 11 000</b>	<b>Double turning holder sq. 20</b>	
	Weight [kg]:	2.250
	Shank type:	BMT
	Machine adaption:	Centering key b 20
	Tool adaption:	Sq. 20
	Coolant:	EXT
<b>8 251 11 003</b>	<b>Double turning holder sq. 20</b>	
	Weight [kg]:	2.420
	Notation:	180° reversible
	Employment for:	right cutting tools
	Shank type:	BMT
	Machine adaption:	Centering key b 20
	Tool adaption:	Sq. 20
		Sq. 20
	Coolant:	EXT

Part-#	Name	
<b>8 251 11 007</b>	<b>Double turning holder sq. 3/4"</b>	
	Weight [kg]:	2.390
	Notation:	180° reversible
	Employment for:	right cutting tools
	Shank type:	BMT
	Machine adaption:	Centering key b 20
	Tool adaption:	Sq. 3/4" (19,05mm)
		Sq. 3/4" (19,05mm)
	Coolant:	EXT
<b>8 251 12 006</b>	<b>Double turning holder sq. 25</b>	
	Weight [kg]:	4.910
	Notation:	180° reversible
	Employment for:	right cutting tools
	Shank type:	BMT
	Machine adaption:	Centering key b 20
	Tool adaption:	Sq. 25
	Coolant:	EXT
<b>8 251 15 048</b>	<b>Combi double turning holder sq. 25 IC</b>	
	Notation:	180° reversible
	Employment for:	Main- and sub spindle
	Shank type:	BMT
	Machine adaption:	Centering key b 20
	Tool adaption:	Sq. 25
		Sq. 25
		Sq. 25
		Sq. 25
	Coolant:	IC/Ext
	Pressure max [bar]:	100
	Please note:	Key rail
<b>8 253 15 014</b>	<b>Double boring bar holder Ø 16</b>	
	Weight [kg]:	5.500
	Notation:	180° reversible
	Version:	Special
	Shank type:	BMT
	Machine adaption:	Centering key b 20
	Tool adaption:	Ø 16
		Ø 16
	Coolant:	IC/Ext
	Center distance [mm]:	56/99
<b>8 253 16 016</b>	<b>Double boring bar holder Ø 20</b>	
	Weight [kg]:	5.360
	Notation:	180° reversible
	Version:	Special
	Shank type:	BMT
	Machine adaption:	Centering key b 20
	Tool adaption:	Ø 20
		Ø 20
	Coolant:	IC/Ext
	Center distance [mm]:	56/99

Part-#	Name	
<b>8 253 17 004</b>	<b>Double boring bar holder Ø 25</b>	
	Weight [kg]:	2.840
	Shank type:	BMT
	Machine adaption:	Centering key b 20
	Tool adaption:	Ø 25
	Coolant:	IC/Ext
	Center distance [mm]:	43/88
<b>8 253 17 010</b>	<b>Double boring bar holder Ø 25 - W 1418-2</b>	
	Weight [kg]:	3.080
	Notation:	180° reversible
	Shank type:	BMT
	Machine adaption:	Centering key b 20
	Tool adaption:	Ø 25
		Ø 25
	Coolant:	IC/Ext
	Center distance [mm]:	56/99
<b>8 253 17 012</b>	<b>Multiple boring bar holder 2x Ø 25</b>	
	Weight [kg]:	3.980
	Notation:	offset
	Shank type:	BMT
	Tool adaption:	Ø 25
		Ø 25 - 30°
	Coolant:	IC/Ext
	Center distance [mm]:	75
<b>8 253 17 051</b>	<b>Multiple boring bar holder Ø 1"</b>	
	Weight [kg]:	3.060
	Notation:	180° reversible
	Shank type:	BMT
	Machine adaption:	Centering key b 20
	Tool adaption:	Ø 1" (25,4mm)
		Ø 1" (25,4mm)
	Coolant:	IC/Ext
	Center distance [mm]:	56/99
<b>8 253 17 090</b>	<b>Double boring bar holder Ø 25</b>	
	Weight [kg]:	2.970
	Notation:	180° reversible
	Version:	offset
	Shank type:	BMT
	Machine adaption:	Centering key b 20
	Tool adaption:	Ø 25
		Ø 25
	Coolant:	IC/Ext
	Center distance [mm]:	56/99
<b>8 253 18 000</b>	<b>Double boring bar holder Ø 32</b>	
	Weight [kg]:	4.640
	Shank type:	BMT
	Machine adaption:	Centering key b 20
	Tool adaption:	Ø 32
	Coolant:	IC/Ext
	Center distance [mm]:	56/99

Part-#	Name	
<b>8 253 18 017</b>	<b>Double boring bar holder Ø 32</b>	
	Weight [kg]:	4.730
	Notation:	180° reversible
	Version:	Special
	Shank type:	BMT
	Machine adaption:	Centering key b 20
	Tool adaption:	Ø 32
		Ø 32
	Coolant:	IC/Ext
	Center distance [mm]:	56/99
<b>8 259 15 001</b>	<b>Multiple holder C 3 and sq. 20</b>	
	Weight [kg]:	3.960
	Notation:	180° reversible
	Shank type:	BMT
	Machine adaption:	Centering key b 20
	Tool adaption:	Sq. 20
		heimatec Capto(TM) C 3
	Coolant:	IC/Ext
	Center distance [mm]:	55
<b>8 259 19 002</b>	<b>Multiple holder ER 25 and sq. 20</b>	
	Weight [kg]:	3.620
	Notation:	180° reversible
	Shank type:	BMT
	Machine adaption:	Centering key b 20
	Tool adaption:	Sq. 20
		ER 25
	Coolant:	IC/Ext
	Center distance [mm]:	55
<b>8 261 18 003</b>	<b>Tool holder for centering insert</b>	
	Weight [kg]:	5.960
	Notation:	180° reversible
	Shank type:	BMT
	Machine adaption:	Centering key b 20
	Tool adaption:	Ø 32
	Coolant:	EXT
	Please note:	Price without centering point
	Center distance [mm]:	55 or 75
<b>8 261 18 004</b>	<b>Tool holder for centering insert</b>	
	Notation:	180° reversible
	Version:	Special
	Shank type:	BMT
	Machine adaption:	Centering key b 20
	Tool adaption:	Ø 34
	Coolant:	EXT
	Please note:	Price without centering point
	Center distance [mm]:	55

Part-#	Name	
<b>8 262 19 001</b>	<b>Stock stop Ø 60 offset</b>	
	Weight [kg]:	3.440
	Notation:	rotating
	Shank type:	BMT
	Machine adaption:	Centering key b 20
	Coolant:	no
	Please note:	Lenght adjustable
	Center distance [mm]:	75
<b>8 263 18 000</b>	<b>Cutter holder with rotating spring-loaded centering point</b>	
	Weight [kg]:	4.810
	Notation:	180° reversible
	Version:	Special
	Shank type:	BMT
	Machine adaption:	Centering key b 20
	Rotation max [1/min]:	6000
	Coolant:	EXT
	Please note:	Taper roller bearings
	Center distance [mm]:	75
<b>8 263 19 002</b>	<b>Tool holder with rotating centering point</b>	
	Weight [kg]:	4.280
	Notation:	180° reversible
	Shank type:	BMT
	Machine adaption:	Centering key b 20
	Rotation max [1/min]:	6000
	Coolant:	EXT
	Please note:	Taper roller bearings
	Center distance [mm]:	75
<b>8 263 19 003</b>	<b>Tool holder with rotating centering point</b>	
	Weight [kg]:	6.000
	Notation:	180° reversible
	Version:	Special
	Shank type:	BMT
	Machine adaption:	Centering key b 20
	Coolant:	EXT
	Please note:	Taper roller bearings
	Center distance [mm]:	100
<b>8 263 19 007</b>	<b>Tool holder with rotating centering point</b>	
	Weight [kg]:	4.375
	Notation:	180° reversible
	Shank type:	BMT
	Machine adaption:	Centering key b 20
	Rotation max [1/min]:	6000
	Coolant:	EXT
	Please note:	Taper roller bearings
	Center distance [mm]:	75
<b>8 263 19 008</b>	<b>Tool holder with rotating centering point</b>	
	Weight [kg]:	6.140
	Notation:	180° reversible
	Version:	Special
	Shank type:	BMT
	Machine adaption:	Centering key b 20
	Rotation max [1/min]:	6000

Part-#	Name	
	Coolant:	EXT
	Please note:	Taper roller bearings
	Center distance [mm]:	100
<b>8 263 19 012</b>	<b>Tool holder with rotating centering point</b>	
	Weight [kg]:	4.340
	Notation:	180° reversible
	Version:	Special
	Shank type:	BMT
	Machine adaption:	Centering key b 20
	Rotation max [1/min]:	6000
	Coolant:	EXT
	Please note:	Taper roller bearings
	Center distance [mm]:	75
<b>8 263 19 013</b>	<b>Tool holder with rotating centering point</b>	
	Weight [kg]:	4.290
	Notation:	180° reversible
	Version:	Special
	Shank type:	BMT
	Machine adaption:	Centering key b 20
	Rotation max [1/min]:	6000
	Coolant:	EXT
	Please note:	Taper roller bearings
	Center distance [mm]:	75
<b>8 263 19 014</b>	<b>Tool holder with rotating centering point</b>	
	Weight [kg]:	4.090
	Notation:	180° reversible
	Version:	Special
	Shank type:	BMT
	Machine adaption:	Centering key b 20
	Rotation max [1/min]:	6000
	Coolant:	EXT
	Please note:	Taper roller bearings
	Center distance [mm]:	75
<b>8 263 19 021</b>	<b>Tool holder with rotating centering point</b>	
	Notation:	180° reversible
	Version:	Special
	Shank type:	BMT
	Machine adaption:	Centering key b 20
	Rotation max [1/min]:	6000
	Coolant:	EXT
	Please note:	Taper roller bearings
	Center distance [mm]:	75
<b>8 263 19 025</b>	<b>Tool holder with rotating centering point</b>	
	Weight [kg]:	4.370
	Notation:	180° reversible
	Shank type:	BMT
	Machine adaption:	Centering key b 20
	Rotation max [1/min]:	6000
	Coolant:	EXT
	Please note:	Taper roller bearings
	Center distance [mm]:	75

Part-#	Name	
<b>8 320 12 010</b>	<b>Cut-off holder, height adjustable SH 26 IC</b>	
	Weight [kg]:	1.680
	Notation:	180° reversible
	Shank type:	BMT
	Machine adaption:	Centering key b 20
	Tool adaption:	Clampshaft SH 26
	Coolant:	IC/Ext
	Pressure max [bar]:	70
<b>8 320 12 020</b>	<b>Cut-off holder, height adjustable SH 26 IC</b>	
	Notation:	180° reversible
	Shank type:	BMT
	Machine adaption:	Centering key b 20
	Tool adaption:	Clampshaft SH 26
	Coolant:	IC/Ext
	Pressure max [bar]:	70
	Please note:	with offset cut-off tool holder
<b>8 320 13 002</b>	<b>Cut-off holder, height adjustable SH 32 IC</b>	
	Weight [kg]:	1.570
	Notation:	180° reversible
	Shank type:	BMT
	Machine adaption:	Centering key b 20
	Tool adaption:	Clampshaft SH 32
	Coolant:	IC/Ext
	Pressure max [bar]:	70
<b>8 320 13 010</b>	<b>Cut-off holder, height adjustable SH 32 IC</b>	
	Weight [kg]:	1.730
	Notation:	180° reversible
	Shank type:	BMT
	Machine adaption:	Centering key b 20
	Tool adaption:	Clampshaft SH 32
	Coolant:	IC/Ext
	Pressure max [bar]:	70
	Please note:	Clampshaft internal
<b>8 320 13 015</b>	<b>Cut-off holder, height adjustable SH 32 IC</b>	
	Weight [kg]:	1.830
	Notation:	180° reversible
	Shank type:	BMT
	Machine adaption:	Centering key b 20
	Tool adaption:	Clampshaft SH 32
	Coolant:	IC/Ext
	Pressure max [bar]:	70
	Please note:	with offset cut-off tool holder
<b>8 782 16 001</b>	<b>Spacer plate 20mm</b>	
	Shank type:	BMT
	Machine adaption:	Centering key b 20
	Tool adaption:	Centering key slot b 20
	Coolant:	EXT
	Please note:	Plate without fastening screws !

Part-#	Name
--------	------

8 782 16 003

**Spacer plate 25mm**

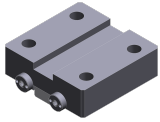

Shank type:

Machine adaption:

Tool adaption:

Coolant:

Please note:

BMT

Centering key b 20

Centering key slot b 20

EXT

Plate without fastening screws !



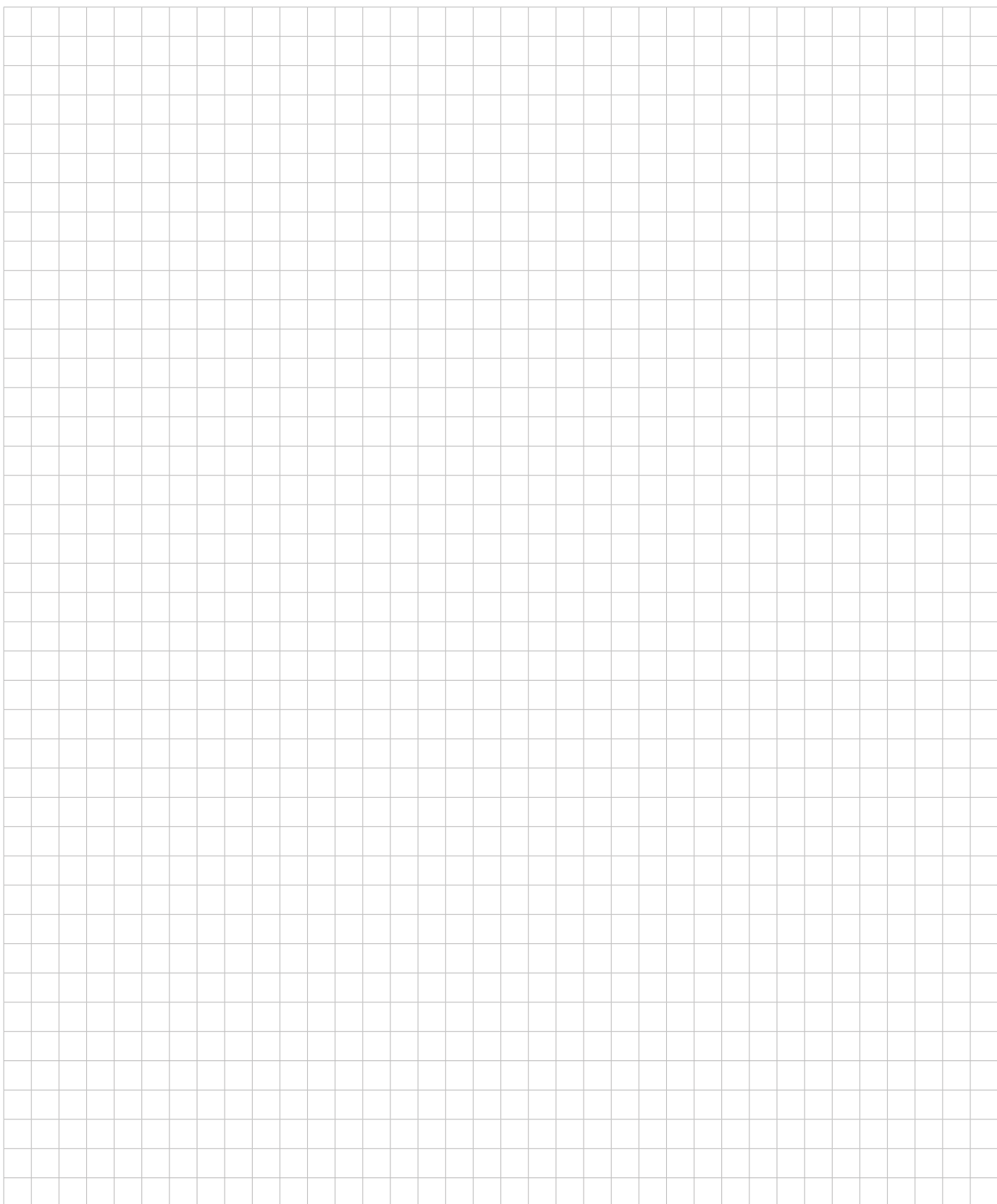

## heimatec.u-tec®

heimatec.com

Products / Tool change systems /  
u-tec® Tool-changing system



versions see catalog

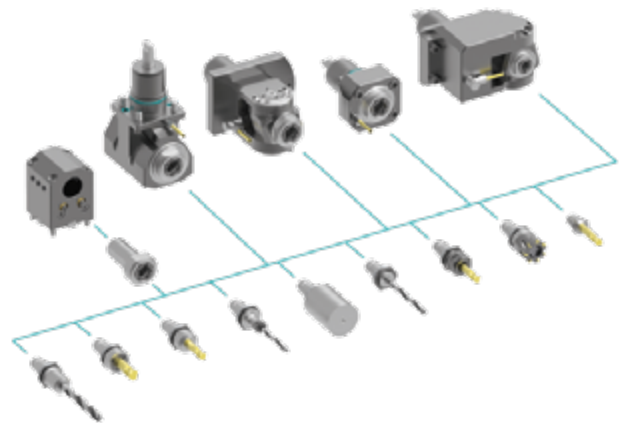

## heimatec.easy-quick

heimatec.com

Products / Tool change systems /  
easy-quick HT quick-changing system



versions see catalog

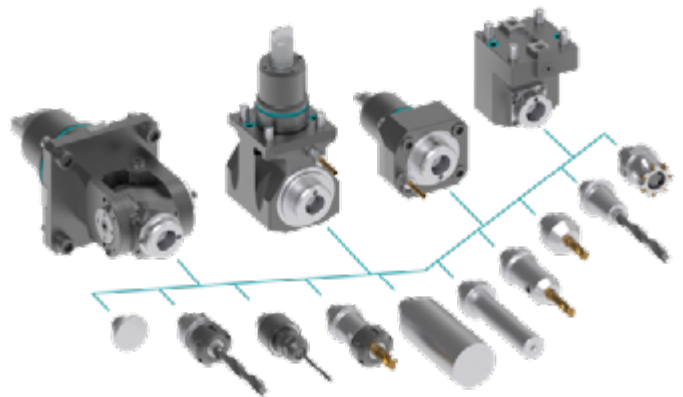

## heimatec.Capto™

heimatec.com

Products / Tool change systems /  
heimatec.Capto™ quick-changing system



versions see catalog

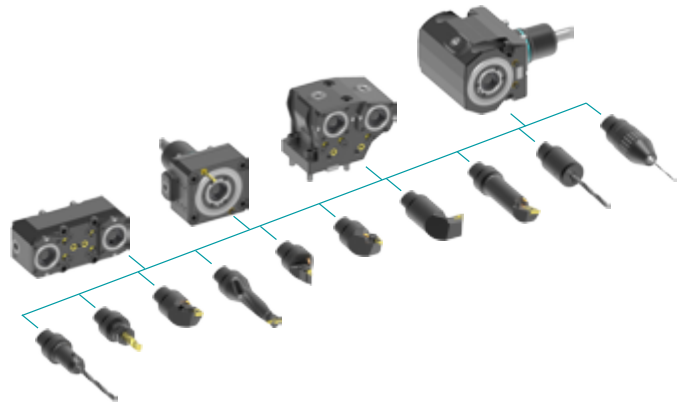

## heimatec.accessories

heimatec.com

Products / Accessories



versions see catalog





● heimatec overseas branches

○ global representations of heimatec

**heimatec**<sup>®</sup>

**heimatec GmbH**  
Präzisionswerkzeuge  
Carl-Benz-Str. 4  
77871 Renchen  
Germany

T +49 7843 9466 0  
[www.heimatec.com](http://www.heimatec.com)  
[info@heimatec.com](mailto:info@heimatec.com)

Please find the contact details of our worldwide trading partners on our website:  
<https://heimatec.com/business-partners>