

Hardinge
GS 200-66 - VDI
40



High-tech from heimatec - heimatec - Tools and systems for productive turning and milling

heimatec belongs to the international technology and quality leaders for precision tools and specializes in the development and production of high-precision static and live tools for all CNC lathes, CNC turn-/mill machines and CNC machining centers.

The range of products* spans from static BMT and VDI tool holders, live tools up to highly complex customer-specific individual solutions. heimatec, headquartered in Renchen, has a own subsidiary in Asia and India and numerous representatives as well as trading partners all over the world.

*OUR PRODCUTS

Static tool holders

Live tool units

Precision tools

Tools for turning and machining centres

Tools for swiss type lathes

Tool changing and uick-change systems

Tool systems for gear production

Digital tool management

This catalogue, including all its parts, is protected by copyright. Any use outside the restricted limitations of the Copyright Act without the consent of heimatec is inadmissible and liable to prosecution. This applies in particular to duplication, translation, microfilming and storage and processing in electronic systems.

heimatec GmbH reserves the right to make technical changes at any time without giving prior notice. This applies in particular to adjustments at any time to meet new or changed international standards, or in case of further developments of our products or manufacturing processes.

The current version of our General Terms and Conditions can be found on our website.

Part-#	Name	
8 010 45 053	Axial drilling and milling head ER 25 IC	
	Weight [kg]:	3.420
	Tool drive:	DIN 5480
	Shank size [mm]:	40.00
	Shank type:	VDI
	Tool adaption:	ER 25
	Gear ratio [i]:	1:1
	Torque max [Nm]:	50
	Rotation max [1/min]:	6000
	Rotating direction:	same
	Coolant:	IC/Ext
	Pressure max [bar]:	25
	Please note:	round housing ø 84
8 010 45 094	Axial drilling and milling head ER 25 AX UT	
	Weight [kg]:	3.440
	Tool drive:	DIN 5480
	Shank size [mm]:	40.00
	Shank type:	VDI
	Tool adaption:	ER 25 A - u-tec
	Gear ratio [i]:	1:1
	Torque max [Nm]:	50
	Rotation max [1/min]:	6000
	Rotating direction:	same
	Coolant:	EXT
8 010 45 156	Axial drilling and milling head ER 25 AX UT IC	
	Weight [kg]:	3.410
	Tool drive:	DIN 5480
	Shank size [mm]:	40.00
	Shank type:	VDI
	Tool adaption:	ER 25 A - u-tec
	Gear ratio [i]:	1:1
	Torque max [Nm]:	50
	Rotation max [1/min]:	6000
	Rotating direction:	same
	Coolant:	IC/Ext
	Pressure max [bar]:	25
8 010 46 152	Axial drilling and milling head ER 32 AX UT	
	Weight [kg]:	3.270
	Tool drive:	DIN 5480
	Shank size [mm]:	40.00
	Shank type:	VDI
	Tool adaption:	ER 32 A - u-tec
	Gear ratio [i]:	1:1
	Torque max [Nm]:	50
	Rotation max [1/min]:	6000
	Rotating direction:	same
	Coolant:	EXT

Part-#	Name
8 010 46 165	Axial drilling and milling head ER 32 AX UT IC
	Weight [kg]: 3.440
	Tool drive: DIN 5480
	Shank size [mm]: 40.00
	Shank type: VDI
	Tool adaption: ER 32 A - u-tec
	Gear ratio [i]: 1:1
	Torque max [Nm]: 50
	Rotation max [1/min]: 6000
	Rotating direction: same
	Coolant: IC/Ext
	Pressure max [bar]: 25
8 010 46 235	Axial drilling and milling head ER 32 AX UT IC
	Tool drive: DIN 5480
	Shank size [mm]: 40.00
	Shank type: VDI
	Tool adaption: ER 32 A - u-tec
	Gear ratio [i]: 1:1
	Torque max [Nm]: 50
	Rotation max [1/min]: 10000
	Rotating direction: same
	Coolant: IC/Ext
	Pressure max [bar]: 100
	Please note: Dryrun possible
8 010 46 304	Axial drilling and milling head C 4
	Weight [kg]: 4.330
	Version: right
	Tool drive: DIN 5480
	Shank size [mm]: 40.00
	Shank type: VDI
	Tool adaption: heimatec Capto(TM) C 4
	Gear ratio [i]: 1:1
	Torque max [Nm]: 50
	Rotation max [1/min]: 6000
	Rotating direction: same
	Coolant: EXT
	Please note: stronger bearing
8 010 47 034	Axial drilling and milling head HT 5
	Weight [kg]: 3.300
	Tool drive: DIN 5480
	Shank size [mm]: 40.00
	Shank type: VDI
	Tool adaption: HT 5
	Gear ratio [i]: 1:1
	Torque max [Nm]: 50
	Rotation max [1/min]: 6000
	Rotating direction: same
	Coolant: EXT
	Please note: round housing Ø 84

Part-#	Name	
8 010 47 086	Axial drilling and milling head HT 5	
	Weight [kg]:	3.330
	Tool drive:	DIN 5480
	Shank size [mm]:	40.00
	Shank type:	VDI
	Tool adaption:	HT 5
	Gear ratio [i]:	1:1
	Torque max [Nm]:	50
	Rotation max [1/min]:	4000
	Rotating direction:	same
	Coolant:	EXT
	Please note:	Combi bearing
8 010 48 001	Axial drilling and milling head HT 6 IC	
	Weight [kg]:	4.220
	Tool drive:	DIN 5480
	Shank size [mm]:	40.00
	Shank type:	VDI
	Tool adaption:	HT 6
	Gear ratio [i]:	1:1
	Torque max [Nm]:	50
	Rotation max [1/min]:	6000
	Rotating direction:	same
	Coolant:	IC/Ext
	Pressure max [bar]:	25
	Please note:	round housing ø 84
8 013 44 005	Axial drilling and milling head ER 16 AX UT	
	Weight [kg]:	2.940
	Tool drive:	DIN 5480
	Shank size [mm]:	40.00
	Shank type:	VDI
	Tool adaption:	ER 16 A - u-tec
	Gear ratio [i]:	1:4
	Torque max [Nm]:	5
	Rotation max [1/min]:	24000
	Rotating direction:	same
	Coolant:	EXT
8 030 45 085	Radial drilling and milling head ER 25	
	Weight [kg]:	6.560
	Version:	right
	Tool drive:	DIN 5480
	Shank size [mm]:	40.00
	Shank type:	VDI
	Tool adaption:	ER 25
	Gear ratio [i]:	1:1
	Torque max [Nm]:	50
	Rotation max [1/min]:	6000
	Rotating direction:	opposite
	Coolant:	EXT
	Center distance [mm]:	100

Part-#	Name	
8 030 45 223	Radial drilling and milling head ER 25 AX UT	
	Weight [kg]:	6.520
	Version:	right
	Tool drive:	DIN 5480
	Shank size [mm]:	40.00
	Shank type:	VDI
	Tool adaption:	ER 25 A - u-tec
	Gear ratio [i]:	1:1
	Torque max [Nm]:	50
	Rotation max [1/min]:	6000
	Rotating direction:	opposite
	Coolant:	EXT
	Center distance [mm]:	100
8 030 46 307	Radial drilling and milling head ER 32 AX UT	
	Weight [kg]:	6.310
	Version:	right
	Tool drive:	DIN 5480
	Shank size [mm]:	40.00
	Shank type:	VDI
	Tool adaption:	ER 32 A - u-tec
	Gear ratio [i]:	1:1
	Torque max [Nm]:	50
	Rotation max [1/min]:	6000
	Rotating direction:	opposite
	Coolant:	EXT
	Center distance [mm]:	100
8 030 46 317	Radial drilling and milling head ER 32 AX UT	
	Weight [kg]:	7.280
	Version:	right
	Tool drive:	DIN 5480
	Shank size [mm]:	40.00
	Shank type:	VDI
	Tool adaption:	ER 32 A - u-tec
	Gear ratio [i]:	1:1
	Torque max [Nm]:	50
	Rotation max [1/min]:	6000
	Rotating direction:	opposite
	Coolant:	EXT
	Center distance [mm]:	120
8 033 46 115	Radial drilling and milling head ER 32 AX UT	
	Weight [kg]:	7.630
	Notation:	offset
	Version:	right
	Tool drive:	DIN 5480
	Shank size [mm]:	40.00
	Shank type:	VDI
	Tool adaption:	ER 32 A - u-tec
	Gear ratio [i]:	1:1
	Torque max [Nm]:	50
	Rotation max [1/min]:	6000
	Rotating direction:	same
	Coolant:	EXT
	Center distance [mm]:	100

Part-#	Name	
8 033 47 013	Radial drilling and milling head HT 5 IC	
	Weight [kg]:	8.480
	Notation:	offset
	Version:	right
	Tool drive:	DIN 5480
	Shank size [mm]:	40.00
	Shank type:	VDI
	Tool adaption:	HT 5
	Gear ratio [i]:	1:1
	Torque max [Nm]:	50
	Rotation max [1/min]:	6000
	Rotating direction:	same
	Coolant:	IC/Ext
	Pressure max [bar]:	140
	Center distance [mm]:	100
8 036 46 010	Radial drilling and milling head ER 32 AX UT	
	Weight [kg]:	6.490
	Version:	doubletoothed
	Tool drive:	DIN 5480
	Shank size [mm]:	40.00
	Shank type:	VDI
	Tool adaption:	ER 32 A - u-tec
	Gear ratio [i]:	1:1
	Torque max [Nm]:	50
	Rotation max [1/min]:	6000
	Rotating direction:	opposite
	Coolant:	EXT
	Center distance [mm]:	100
8 036 46 011	Radial drilling and milling head ER 32 AX UT IC	
	Weight [kg]:	7.870
	Version:	doubletoothed
	Tool drive:	DIN 5480
	Shank size [mm]:	40.00
	Shank type:	VDI
	Tool adaption:	ER 32 A - u-tec
	Gear ratio [i]:	1:1
	Torque max [Nm]:	50
	Rotation max [1/min]:	6000
	Rotating direction:	opposite
	Coolant:	IC/Ext
	Pressure max [bar]:	140
	Center distance [mm]:	120
8 036 46 012	Radial drilling and milling head ER 32 AX UT IC	
	Weight [kg]:	6.920
	Version:	doubletoothed
	Tool drive:	DIN 5480
	Shank size [mm]:	40.00
	Shank type:	VDI
	Tool adaption:	ER 32 A - u-tec
	Gear ratio [i]:	1:1
	Torque max [Nm]:	50
	Rotation max [1/min]:	6000
	Rotating direction:	opposite
	Coolant:	IC/Ext
	Pressure max [bar]:	140

Part-#	Name	
	Center distance [mm]:	100
8 040 44 066	Universal head ± 90° adjustable ER 16 AX UT	
	Version:	right
	Tool drive:	DIN 5480
	Shank size [mm]:	40.00
	Shank type:	VDI
	Tool adaption:	ER 16 A - u-tec
	Gear ratio [i]:	1:1
	Torque max [Nm]:	25
	Rotation max [1/min]:	6000
	Rotating direction:	opposite
	Coolant:	EXT
	Center distance [mm]:	87
8 040 44 067	Universal head ± 90° adjustable ER 16 AX UT	
	Weight [kg]:	4.890
	Version:	left
	Tool drive:	DIN 5480
	Shank size [mm]:	40.00
	Shank type:	VDI
	Tool adaption:	ER 16 A - u-tec
	Gear ratio [i]:	1:1
	Torque max [Nm]:	25
	Rotation max [1/min]:	6000
	Rotating direction:	opposite
	Coolant:	EXT
	Center distance [mm]:	87
8 040 44 070	Universal head ± 90° adjustable ER 16 AX UT IC	
	Version:	right
	Tool drive:	DIN 5480
	Shank size [mm]:	40.00
	Shank type:	VDI
	Tool adaption:	ER 16 A - u-tec
	Gear ratio [i]:	1:1
	Torque max [Nm]:	25
	Rotation max [1/min]:	6000
	Rotating direction:	opposite
	Coolant:	IC/Ext
	Pressure max [bar]:	140
	Center distance [mm]:	87
8 040 45 067	Universal head ± 90° adjustable ER 25 AX UT	
	Weight [kg]:	6.250
	Version:	right
	Tool drive:	DIN 5480
	Shank size [mm]:	40.00
	Shank type:	VDI
	Tool adaption:	ER 25 A - u-tec
	Gear ratio [i]:	1:1
	Torque max [Nm]:	25
	Rotation max [1/min]:	6000
	Rotating direction:	opposite
	Coolant:	EXT
	Please note:	Note swivel range! strong bearing
	Center distance [mm]:	120

Part-#	Name
8 040 45 073	Universal head ± 90° adjustable ER 25 AX UT IC
	<p>Version: left</p> <p>Tool drive: DIN 5480</p> <p>Shank size [mm]: 40.00</p> <p>Shank type: VDI</p> <p>Tool adaption: ER 25 A - u-tec</p> <p>Gear ratio [i]: 1:1</p> <p>Torque max [Nm]: 25</p> <p>Rotation max [1/min]: 6000</p> <p>Rotating direction: opposite</p> <p>Coolant: IC/Ext</p> <p>Pressure max [bar]: 140</p> <p>Please note: stronger bearing</p> <p>Center distance [mm]: 87</p>
8 040 45 093	Universal head ± 90° adjustable ER 25 AX UT
	<p>Weight [kg]: 5.160</p> <p>Version: right</p> <p>Tool drive: DIN 5480</p> <p>Shank size [mm]: 40.00</p> <p>Shank type: VDI</p> <p>Tool adaption: ER 25 A - u-tec</p> <p>Gear ratio [i]: 1:1</p> <p>Torque max [Nm]: 25</p> <p>Rotation max [1/min]: 6000</p> <p>Rotating direction: opposite</p> <p>Coolant: EXT</p> <p>Please note: stronger bearing</p> <p>Center distance [mm]: 87</p>
8 040 45 095	Universal head ± 90° adjustable ER 25 AX UT IC
	<p>Weight [kg]: 5.160</p> <p>Version: right</p> <p>Tool drive: DIN 5480</p> <p>Shank size [mm]: 40.00</p> <p>Shank type: VDI</p> <p>Tool adaption: ER 25 A - u-tec</p> <p>Gear ratio [i]: 1:1</p> <p>Torque max [Nm]: 25</p> <p>Rotation max [1/min]: 6000</p> <p>Rotating direction: opposite</p> <p>Coolant: IC/Ext</p> <p>Pressure max [bar]: 140</p> <p>Please note: stronger bearing</p> <p>Center distance [mm]: 87</p>
8 040 45 103	Universal head ± 90° adjustable ER 25 AX UT IC
	<p>Weight [kg]: 5.170</p> <p>Version: left; at 65° position can be pinned</p> <p>Tool drive: DIN 5480</p> <p>Shank size [mm]: 40.00</p> <p>Shank type: VDI</p> <p>Tool adaption: ER 25 A - u-tec</p> <p>Gear ratio [i]: 1:1</p> <p>Torque max [Nm]: 25</p> <p>Rotation max [1/min]: 6000</p> <p>Rotating direction: opposite</p> <p>Coolant: IC/Ext</p>

Part-#	Name	
	Pressure max [bar]:	140
	Please note:	stronger bearing
	Center distance [mm]:	87
8 040 45 139	Universal head ± 90° adjustable ER 25	
	Weight [kg]:	5.230
	Version:	left
	Tool drive:	DIN 5480
	Shank size [mm]:	40.00
	Shank type:	VDI
	Tool adaption:	ER 25
	Gear ratio [i]:	1:1
	Torque max [Nm]:	25
	Rotation max [1/min]:	6000
	Rotating direction:	opposite
	Coolant:	EXT
	Please note:	stronger bearing
	Center distance [mm]:	87
8 200 40 000	Plug Z2-40 K	
	Weight [kg]:	0.140
	Shank size [mm]:	40.00
	Shank type:	VDI
8 200 40 001	Plug Z2-40 S	
	Weight [kg]:	1.360
	Shank size [mm]:	40.00
	Shank type:	VDI
8 200 41 002	Tool holder A2-40x120	
	Weight [kg]:	5.800
	Shank size [mm]:	40.00
	Shank type:	VDI
8 200 41 003	Tool holder A2-40x200	
	Weight [kg]:	9.120
	Shank size [mm]:	40.00
	Shank type:	VDI
8 200 41 004	Tool holder A2-40x320	
	Weight [kg]:	14.360
	Shank size [mm]:	40.00
	Shank type:	VDI
8 200 44 000	Tool holder A1-40x100	
	Weight [kg]:	11.940
	Shank size [mm]:	40.00
	Shank type:	VDI
8 202 43 000	Basic holder transversal set SZ 40	
	Weight [kg]:	1.560
	Shank size [mm]:	40.00
	Shank type:	VDI
	Tool adaption:	Interface SZ 40
	Coolant:	EXT

Part-#	Name	
8 206 42 000	Adapter for VDI 30	
	Weight [kg]:	3.530
	Version:	doubletoothed
	Shank size [mm]:	40.00
	Shank type:	VDI
	Tool adaption:	DIN 69880 - 30
	Coolant:	EXT
	Please note:	Special
8 208 49 001	Test mandrel VDI 40x40x200	
	Weight [kg]:	3.020
	Shank size [mm]:	40.00
	Shank type:	VDI
8 208 49 003	Test mandrel VDI 40x40x300	
	Weight [kg]:	4.020
	Shank size [mm]:	40.00
	Shank type:	VDI
8 210 41 000	Tool holder F 40-MK 1	
	Weight [kg]:	1.600
	Shank size [mm]:	40.00
	Shank type:	VDI
	Tool adaption:	DIN 228 D - MK 1
	Coolant:	IC
8 210 42 001	Tool holder F 40-MK 2	
	Weight [kg]:	1.620
	Shank size [mm]:	40.00
	Shank type:	VDI
	Tool adaption:	DIN 228 D - MK 2
	Coolant:	IC
8 210 43 000	Tool holder E2-40x 8	
	Shank size [mm]:	40.00
	Shank type:	VDI
	Tool adaption:	Ø 8
	Coolant:	IC/Ext
8 210 43 002	Tool holder F 40-MK 3	
	Weight [kg]:	1.520
	Shank size [mm]:	40.00
	Shank type:	VDI
	Tool adaption:	DIN 228 D - MK 3
	Coolant:	IC
8 210 43 003	Short drill chuck VDI 40x 8	
	Weight [kg]:	1.700
	Shank size [mm]:	40.00
	Shank type:	VDI
	Coolant:	EXT
8 210 43 004	Short drill chuck VDI 40x 8 - IC	
	Weight [kg]:	1.730
	Shank size [mm]:	40.00
	Shank type:	VDI
	Coolant:	IC

Part-#	Name	
8 210 44 001	Tool holder E2-40x10	
	Weight [kg]:	2.320
	Shank size [mm]:	40.00
	Shank type:	VDI
	Tool adaption:	Ø 10
	Coolant:	IC/Ext
8 210 44 007	Tool holder F 40-MK 4	
	Weight [kg]:	2.460
	Shank size [mm]:	40.00
	Shank type:	VDI
	Tool adaption:	DIN 228 D - MK 4
	Coolant:	IC
8 210 44 008	Short drill chuck VDI 40x13	
	Weight [kg]:	2.280
	Shank size [mm]:	40.00
	Shank type:	VDI
	Coolant:	EXT
8 210 44 009	Tool holder E2-40x14	
	Shank size [mm]:	40.00
	Shank type:	VDI
	Tool adaption:	Ø 14
	Coolant:	IC/Ext
8 210 44 010	Tool holder E1-40x10	
	Shank size [mm]:	40.00
	Shank type:	VDI
	Tool adaption:	Ø 10
	Coolant:	IC
8 210 44 011	Tool holder E1-40x12	
	Shank size [mm]:	40.00
	Shank type:	VDI
	Tool adaption:	Ø 12
	Coolant:	IC
8 210 44 014	Short drill chuck VDI 40x13 - IC	
	Weight [kg]:	2.290
	Shank size [mm]:	40.00
	Shank type:	VDI
	Coolant:	IC
8 210 44 017	Tool holder E1-40x14	
	Shank size [mm]:	40.00
	Shank type:	VDI
	Tool adaption:	Ø 14
	Coolant:	IC
8 210 44 018	Tool holder E1-40x12,5 - special	
	Shank size [mm]:	40.00
	Shank type:	VDI
	Tool adaption:	Ø 12,5
	Coolant:	IC
	Please note:	Special version

Part-#	Name	
8 210 44 019	Tool holder E2-40x10 - special	
	Shank size [mm]:	40.00
	Shank type:	VDI
	Tool adaption:	Ø 10
	Coolant:	IC/Ext
	Please note:	Shaft with hole, locked with screw
8 210 44 020	Tool holder E2-40x12 - special	
	Shank size [mm]:	40.00
	Shank type:	VDI
	Tool adaption:	Ø 12
	Coolant:	IC/Ext
	Please note:	Shaft with hole, locked with screw
8 210 45 000	Tool holder E2-40x16	
	Shank size [mm]:	40.00
	Shank type:	VDI
	Tool adaption:	Ø 16
	Coolant:	IC/Ext
8 210 45 002	Tool holder E4-40xER 25	
	Weight [kg]:	1.570
	Shank size [mm]:	40.00
	Shank type:	VDI
	Tool adaption:	ER 25
	Coolant:	IC
8 210 45 003	Tool holder E1-40x16	
	Shank size [mm]:	40.00
	Shank type:	VDI
	Tool adaption:	Ø 16
	Coolant:	IC
8 210 45 006	Short drill chuck VDI 40x16	
	Weight [kg]:	2.460
	Shank size [mm]:	40.00
	Shank type:	VDI
	Coolant:	EXT
8 210 45 007	Tool holder E3-40x C 16	
	Shank size [mm]:	40.00
	Shank type:	VDI
	Tool adaption:	DIN 6388 - C 16
	Coolant:	IC
8 210 45 009	Short drill chuck VDI 40x16 - IC	
	Weight [kg]:	2.320
	Shank size [mm]:	40.00
	Shank type:	VDI
	Coolant:	IC

Part-#	Name	
8 210 45 012	Tool holder E2-40x16 - special	
	Version:	with 180° rotated fixed clamping
	Shank size [mm]:	40.00
	Shank type:	VDI
	Tool adaption:	Ø 16
	Coolant:	IC/Ext
	Please note:	Special version
8 210 45 013	Tool holder E2-40x18	
	Shank size [mm]:	40.00
	Shank type:	VDI
	Tool adaption:	Ø 18
	Coolant:	IC/Ext
8 210 45 014	Tool holder E1-40x18	
	Shank size [mm]:	40.00
	Shank type:	VDI
	Tool adaption:	Ø 18
	Coolant:	IC
8 210 45 020	Tool holder ER 25 AX UT IC	
	Weight [kg]:	1.860
	Shank size [mm]:	40.00
	Shank type:	VDI
	Tool adaption:	ER 25 A - u-tec
	Coolant:	IC/Ext
8 210 46 000	Tool holder E4-40xER 32	
	Weight [kg]:	1.640
	Shank size [mm]:	40.00
	Shank type:	VDI
	Tool adaption:	ER 32
	Coolant:	IC
8 210 46 002	Tool holder E2-40x20	
	Shank size [mm]:	40.00
	Shank type:	VDI
	Tool adaption:	Ø 20
	Coolant:	IC/Ext
8 210 46 004	Tool holder E1-40x20	
	Shank size [mm]:	40.00
	Shank type:	VDI
	Tool adaption:	Ø 20
	Coolant:	IC
8 210 46 008	Tool holder HT 4 IC	
	Version:	right / left
	Shank size [mm]:	40.00
	Shank type:	VDI
	Tool adaption:	HT 4
	Coolant:	IC/Ext
	Please note:	HT- insert 3x 90° demountable

Part-#	Name	
8 210 46 009	Tool holder E2-40x20 - special	
	Version:	with 180° rotated fixed clamping
	Shank size [mm]:	40.00
	Shank type:	VDI
	Tool adaption:	Ø 20
	Coolant:	IC/Ext
	Please note:	Special version
8 210 46 010	Tool holder E2-40x20 - special	
	Shank size [mm]:	40.00
	Shank type:	VDI
	Tool adaption:	Ø 20
	Coolant:	IC/Ext
	Please note:	Shaft with hole, locked with screw
8 210 47 001	Tool holder E2-40x25	
	Shank size [mm]:	40.00
	Shank type:	VDI
	Tool adaption:	Ø 25
	Coolant:	IC/Ext
8 210 47 003	Tool holder E3-40x C 25	
	Weight [kg]:	1.980
	Shank size [mm]:	40.00
	Shank type:	VDI
	Tool adaption:	DIN 6388 - C 25
	Coolant:	IC
8 210 47 004	Tool holder E4-40xER 40	
	Shank size [mm]:	40.00
	Shank type:	VDI
	Tool adaption:	ER 40
	Coolant:	IC
8 210 47 005	Tool holder E1-40x25	
	Weight [kg]:	1.840
	Shank size [mm]:	40.00
	Shank type:	VDI
	Tool adaption:	Ø 25
	Coolant:	IC
8 210 47 009	Tool holder E2-40x25 - special	
	Version:	with 180° rotated fixed clamping
	Shank size [mm]:	40.00
	Shank type:	VDI
	Tool adaption:	Ø 25
	Coolant:	IC/Ext
	Please note:	Special version
8 210 47 010	Tool holder HT 5 IC	
	Version:	right / left
	Shank size [mm]:	40.00
	Shank type:	VDI
	Tool adaption:	HT 5
	Coolant:	IC/Ext
	Please note:	HT- insert 3x 90° demountable

Part-#	Name	
8 210 47 012	Tool holder HT 5 IC	
	Weight [kg]:	1.880
	Version:	left
	Shank size [mm]:	40.00
	Shank type:	VDI
	Tool adaption:	HT 5
	Coolant:	IC/Ext
8 210 48 001	Tool holder E2-40x32	
	Shank size [mm]:	40.00
	Shank type:	VDI
	Tool adaption:	Ø 32
	Coolant:	IC/Ext
8 210 48 003	Tool holder E3-40x C 32	
	Weight [kg]:	2.480
	Shank size [mm]:	40.00
	Shank type:	VDI
	Tool adaption:	DIN 6388 - C 32
	Coolant:	IC
8 210 48 004	Tool holder E1-40x32	
	Weight [kg]:	1.830
	Shank size [mm]:	40.00
	Shank type:	VDI
	Tool adaption:	Ø 32
	Coolant:	IC
8 210 48 008	Tool holder E2-40x32 - special	
	Version:	with 180° rotated fixed clamping
	Shank size [mm]:	40.00
	Shank type:	VDI
	Tool adaption:	Ø 32
	Coolant:	IC/Ext
	Please note:	Special version
8 210 48 009	Tool holder E2-40x32 - special	
	Version:	Special
	Shank size [mm]:	40.00
	Shank type:	VDI
	Tool adaption:	Ø 32
	Coolant:	IC/Ext
8 210 48 012	Tool holder E2-40x32 special	
	Version:	Special
	Shank size [mm]:	40.00
	Shank type:	VDI
	Tool adaption:	Ø 32
	Coolant:	IC/Ext
	Please note:	with end stop
8 210 49 000	Tool holder E2-40x40	
	Shank size [mm]:	40.00
	Shank type:	VDI
	Tool adaption:	Ø 40
	Coolant:	IC/Ext

Part-#	Name	
8 210 49 002	Tool holder E1-40x40	
	Shank size [mm]:	40.00
	Shank type:	VDI
	Tool adaption:	Ø 40
	Coolant:	IC
8 210 49 003	Tool holder E1-40x50	
	Shank size [mm]:	40.00
	Shank type:	VDI
	Tool adaption:	Ø 50
	Coolant:	IC
8 210 49 005	Tool holder E2-40x50	
	Weight [kg]:	3.000
	Shank size [mm]:	40.00
	Shank type:	VDI
	Tool adaption:	Ø 50
	Coolant:	IC/Ext
8 210 49 008	Tool holder E2-40x40 - special	
	Version:	with 180° rotated fixed clamping
	Shank size [mm]:	40.00
	Shank type:	VDI
	Tool adaption:	Ø 40
	Coolant:	IC/Ext
	Please note:	Special version
8 214 43 000	Tool holder C1-40x25	
	Employment for:	VDI 40
	Version:	right
	Shank size [mm]:	40.00
	Shank type:	VDI
	Tool adaption:	Sq. 25/20
	Coolant:	EXT
8 214 43 001	Tool holder C3-40x25	
	Employment for:	VDI 40
	Version:	right
	Shank size [mm]:	40.00
	Shank type:	VDI
	Tool adaption:	Sq. 25/20
	Coolant:	EXT
8 214 43 008	Tool holder C1-40x25 special	
	Shank size [mm]:	40.00
	Shank type:	VDI
	Tool adaption:	Sq. 25/20
	Coolant:	EXT

Part-#	Name	
8 219 47 004	Boring bar holder ø 25	
	Weight [kg]:	2.820
	Version:	left; offset
	Shank size [mm]:	40.00
	Shank type:	VDI
	Tool adaption:	Ø 25
	Coolant:	IC/Ext
	Offset [mm]:	25
8 219 48 006	Boring bar holder ø 32	
	Version:	left, offset
	Shank size [mm]:	40.00
	Shank type:	VDI
	Tool adaption:	Ø 32
	Coolant:	IC/Ext
	Offset [mm]:	30
8 234 43 000	Tool holder B1-40x25x44	
	Employment for:	VDI 40
	Version:	right
	Shank size [mm]:	40.00
	Shank type:	VDI
	Tool adaption:	Sq. 25/20
	Coolant:	EXT
8 234 43 001	Tool holder B3-40x25x44	
	Employment for:	VDI 40
	Shank size [mm]:	40.00
	Shank type:	VDI
	Tool adaption:	Sq. 25/20
	Coolant:	EXT
8 234 43 002	Tool holder B5-40x25x44	
	Weight [kg]:	3.120
	Shank size [mm]:	40.00
	Shank type:	VDI
	Tool adaption:	Sq. 25/20
	Coolant:	EXT
8 234 43 003	Tool holder B7-40x25x44	
	Weight [kg]:	3.320
	Shank size [mm]:	40.00
	Shank type:	VDI
	Tool adaption:	Sq. 25/20
	Coolant:	EXT
8 234 43 005	Tool holder B5-40x25x44 special	
	Shank size [mm]:	40.00
	Shank type:	VDI
	Tool adaption:	Sq. 25/20
	Coolant:	EXT
8 262 49 000	Stock stop VDI 40 - Ø 42	
	Weight [kg]:	1.360
	Shank size [mm]:	40.00
	Shank type:	VDI

Hardinge

GS 200-66 - VDI 40

Part-#	Name	
8 262 49 001	Stock stop VDI 40 - Ø 60	
	Weight [kg]:	1.620
	Shank size [mm]:	40.00
	Shank type:	VDI
8 262 49 002	Stock stop VDI 40 - Ø 54	
	Weight [kg]:	1.530
	Shank size [mm]:	40.00
	Shank type:	VDI
8 267 49 001	Bar pick-up VDI 40 offset	
	Weight [kg]:	2.100
	Version:	right
	Shank size [mm]:	40.00
	Shank type:	VDI
	Please note:	Chuck jaws 62-85 mm special accessories
8 274 43 000	Square multiple holder D1-40x25	
	Weight [kg]:	3.660
	Shank size [mm]:	40.00
	Shank type:	VDI
	Tool adaption:	Sq. 25/20
	Coolant:	EXT
8 274 43 001	Tool holder D2-40x25	
	Weight [kg]:	4.300
	Shank size [mm]:	40.00
	Shank type:	VDI
	Tool adaption:	Sq. 25/20
	Coolant:	EXT
8 320 42 018	Cut-off holder, height adjustable SH 26 IC	
	Version:	universal
	Shank size [mm]:	40.00
	Shank type:	VDI
	Tool adaption:	Clampshaft SH 26
	Coolant:	IC/Ext
	Pressure max [bar]:	70
8 320 43 009	Cut-off holder, height adjustable SH 32 IC	
	Weight [kg]:	2.480
	Version:	universal
	Shank size [mm]:	40.00
	Shank type:	VDI
	Tool adaption:	Clampshaft SH 32
	Coolant:	IC/Ext
	Pressure max [bar]:	70
8 320 47 000	Internal cutting tool height adjust. 25	
	Shank size [mm]:	40.00
	Shank type:	VDI
	Tool adaption:	Ø 25
	Coolant:	IC

Hardinge
GS 200-66 - VDI 40

Part-#	Name
8 320 49 005	Cut-off holder, height adjustable 845 IC
	Weight [kg]: 2.700
	Version: universal
	Shank size [mm]: 40.00
	Shank type: VDI
	Tool adaption:  System 845
	Coolant: IC
	Pressure max [bar]: 70

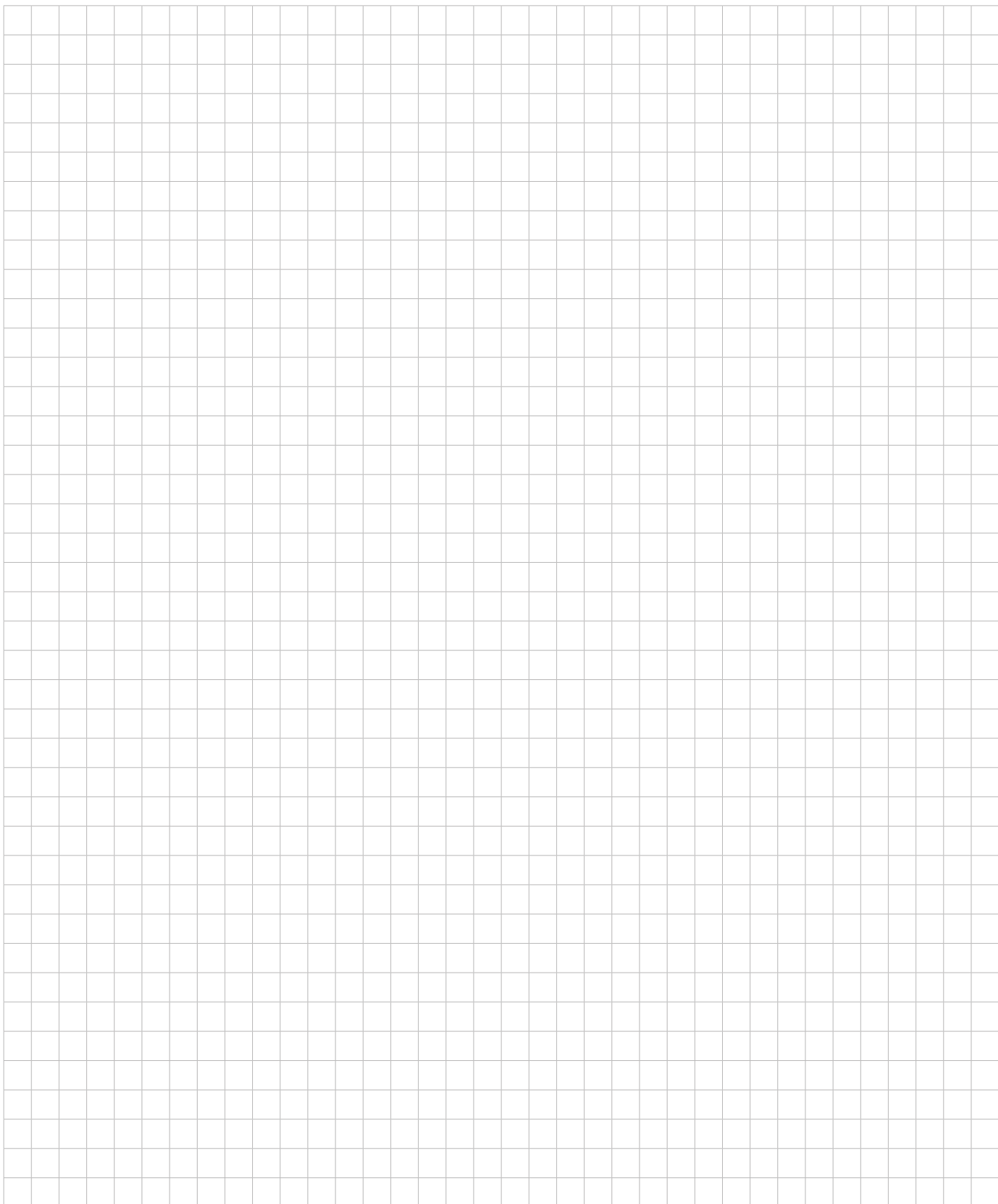



heimatec.u-tec®

heimatec.com

Products / Tool change systems /
u-tec® Tool-changing system



versions see catalog



heimatec.easy-quick

heimatec.com

Products / Tool change systems /
easy-quick HT quick-changing system



versions see catalog



heimatec.Capto™

heimatec.com

Products / Tool change systems /
heimatec.Capto™ quick-changing system



versions see catalog

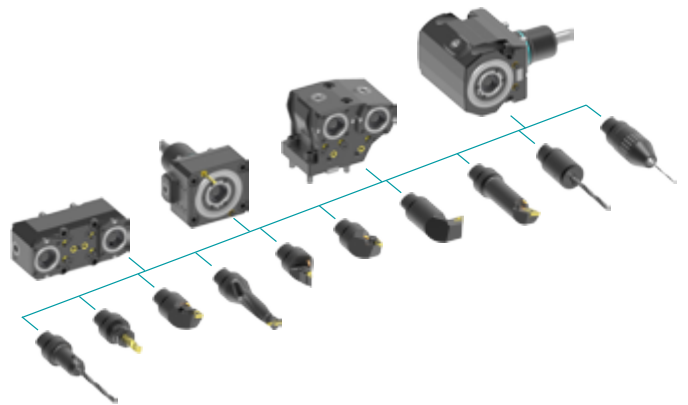

heimatec.accessories

heimatec.com

Products / Accessories



versions see catalog





● heimatec overseas branches

○ global representations of heimatec

heimatec[®]

heimatec GmbH
Präzisionswerkzeuge
Carl-Benz-Str. 4
77871 Renchen
Germany

T +49 7843 9466 0
www.heimatec.com
info@heimatec.com

Please find the contact details of our worldwide trading partners on our website:
<https://heimatec.com/business-partners>