

Miyano

BNA 42 GTY



High-tech from heimatec - heimatec - Tools and systems for productive turning and milling

heimatec belongs to the international technology and quality leaders for precision tools and specializes in the development and production of high-precision static and live tools for all CNC lathes, CNC turn-/mill machines and CNC machining centers.

The range of products* spans from static BMT and VDI tool holders, live tools up to highly complex customer-specific individual solutions. heimatec, headquartered in Renchen, has a own subsidiary in Asia and India and numerous representatives as well as trading partners all over the world.

*OUR PRODCUTS

Static tool holders

Live tool units

Precision tools

Tools for turning and machining centres

Tools for swiss type lathes

Tool changing and uick-change systems

Tool systems for gear production

Digital tool management

This catalogue, including all its parts, is protected by copyright. Any use outside the restricted limitations of the Copyright Act without the consent of heimatec is inadmissible and liable to prosecution. This applies in particular to duplication, translation, microfilming and storage and processing in electronic systems.



heimatec GmbH reserves the right to make technical changes at any time without giving prior notice. This applies in particular to adjustments at any time to meet new or changed international standards, or in case of further developments of our products or manufacturing processes.



The current version of our General Terms and Conditions can be found on our website.

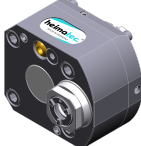
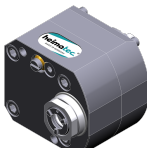

Part-#	Name	
8 010 34 017	Axial drilling and milling head ER 16 AX UT	
	Weight [kg]:	1.450
	Tool drive:	Flat (~DIN 1809)
	Shank size [mm]:	38.00
	Shank type:	BMT
	Tool adaption:	ER 16 A - u-tec
	Gear ratio [i]:	1:1
	Torque max [Nm]:	20
	Rotation max [1/min]:	6000
	Rotating direction:	same
	Coolant:	EXT
8 010 34 018	Axial drilling and milling head ER 16 AX UT IC	
	Weight [kg]:	1.440
	Tool drive:	Flat (~DIN 1809)
	Shank size [mm]:	38.00
	Shank type:	BMT
	Tool adaption:	ER 16 A - u-tec
	Gear ratio [i]:	1:1
	Torque max [Nm]:	20
	Rotation max [1/min]:	6000
	Rotating direction:	same
	Coolant:	IC/Ext
	Pressure max [bar]:	25
8 010 34 022	Axial drilling and milling head ER 20 AX UT	
	Weight [kg]:	1.310
	Version:	Special
	Tool drive:	Flat (~DIN 1809)
	Shank size [mm]:	38.00
	Shank type:	BMT
	Tool adaption:	ER 20 A - u-tec
	Gear ratio [i]:	1:1
	Torque max [Nm]:	20
	Rotation max [1/min]:	6000
	Rotating direction:	same
	Coolant:	EXT
8 010 34 023	Axial drilling and milling head ER 16 AX UT IC	
	Tool drive:	Flat (~DIN 1809)
	Shank size [mm]:	38.00
	Shank type:	BMT
	Tool adaption:	ER 16 A - u-tec
	Gear ratio [i]:	1:1
	Torque max [Nm]:	20
	Rotation max [1/min]:	12000
	Rotating direction:	same
	Coolant:	IC/Ext
	Pressure max [bar]:	100
	Please note:	Dryrun possible

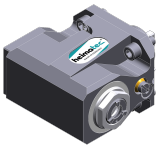
Part-#	Name	
8 010 34 025	Axial drilling and milling head ER 20 AX UT IC	
	Weight [kg]:	1.480
	Version:	Special
	Tool drive:	Flat (~DIN 1809)
	Shank size [mm]:	38.00
	Shank type:	BMT
	Tool adaption:	ER 20 A - u-tec
	Gear ratio [i]:	1:1
	Torque max [Nm]:	20
	Rotation max [1/min]:	12000
	Rotating direction:	same
	Coolant:	IC/Ext
	Pressure max [bar]:	100
	Please note:	Dryrun possible
8 010 34 026	Axial drilling and milling head ER 20 AX UT IC	
	Weight [kg]:	1.500
	Version:	Special
	Tool drive:	Flat (~DIN 1809)
	Shank size [mm]:	38.00
	Shank type:	BMT
	Tool adaption:	ER 20 A - u-tec
	Gear ratio [i]:	1:1
	Torque max [Nm]:	20
	Rotation max [1/min]:	6000
	Rotating direction:	same
	Coolant:	IC/Ext
	Pressure max [bar]:	25
8 010 35 020	Axial drilling and milling head C 3	
	Weight [kg]:	3.280
	Notation:	180° reversible
	Tool drive:	Flat (~DIN 1809)
	Shank size [mm]:	38.00
	Shank type:	BMT
	Tool adaption:	heimatec Capto(TM) C 3
	Gear ratio [i]:	1:1
	Torque max [Nm]:	32
	Rotation max [1/min]:	8000
	Rotating direction:	same
	Coolant:	EXT
	Please note:	Check applicability; tool length check !
8 013 34 007	Axial drilling and milling head ER 16 AX UT	
	Weight [kg]:	1.780
	Tool drive:	Flat (~DIN 1809)
	Shank size [mm]:	38.00
	Shank type:	BMT
	Tool adaption:	ER 16 A - u-tec
	Gear ratio [i]:	1:4
	Torque max [Nm]:	5
	Rotation max [1/min]:	24000
	Rotating direction:	same
	Coolant:	EXT

Part-#	Name	
8 013 34 008	Axial drilling and milling head ER 16 AX UT IC	
	Tool drive:	Flat (~DIN 1809)
	Shank size [mm]:	38.00
	Shank type:	BMT
	Tool adaption:	ER 16 A - u-tec
	Gear ratio [i]:	1:4
	Torque max [Nm]:	5
	Rotation max [1/min]:	24000
	Rotating direction:	same
	Coolant:	IC/Ext
	Pressure max [bar]:	100
	Please note:	Check applicability; note tool length!
8 019 34 004	Axial drilling and milling head ER 16 AX UT	
	Weight [kg]:	2.500
	Notation:	180° reversible
	Tool drive:	Flat (~DIN 1809)
	Shank size [mm]:	38.00
	Shank type:	BMT
	Tool adaption:	ER 16 A - u-tec
	Gear ratio [i]:	1:2
	Torque max [Nm]:	6
	Rotation max [1/min]:	12000
	Rotating direction:	opposite
	Coolant:	EXT
	Offset [mm]:	34,5
8 019 34 005	Axial drilling and milling head ER 16 AX UT IC	
	Weight [kg]:	3.100
	Notation:	180° reversible
	Tool drive:	Flat (~DIN 1809)
	Shank size [mm]:	38.00
	Shank type:	BMT
	Tool adaption:	ER 16 A - u-tec
	Gear ratio [i]:	1:2
	Torque max [Nm]:	6
	Rotation max [1/min]:	12000
	Rotating direction:	opposite
	Coolant:	IC/Ext
	Pressure max [bar]:	140
	Offset [mm]:	34,5
8 019 34 006	Axial drilling and milling head ER 16 AX UT	
	Weight [kg]:	2.510
	Notation:	180° reversible
	Tool drive:	Flat (~DIN 1809)
	Shank size [mm]:	38.00
	Shank type:	BMT
	Tool adaption:	ER 16 A - u-tec
	Gear ratio [i]:	2:1
	Torque max [Nm]:	20
	Rotation max [1/min]:	3000
	Rotating direction:	opposite
	Coolant:	EXT

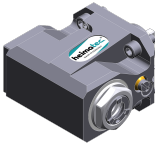
Part-#	Name	
8 019 34 007	Axial drilling and milling head ER 16 AX UT IC	
	Weight [kg]:	3.260
	Notation:	180° reversible
	Tool drive:	Flat (~DIN 1809)
	Shank size [mm]:	38.00
	Shank type:	BMT
	Tool adaption:	ER 16 A - u-tec
	Gear ratio [i]:	2:1
	Torque max [Nm]:	20
	Rotation max [1/min]:	3000
	Rotating direction:	opposite
	Coolant:	IC/Ext
	Pressure max [bar]:	140
	Offset [mm]:	29
8 019 35 012	Axial drilling and milling head C 3 IC	
	Weight [kg]:	5.990
	Tool drive:	Flat (~DIN 1809)
	Shank size [mm]:	38.00
	Shank type:	BMT
	Tool adaption:	heimatec Capto(TM) C 3
	Gear ratio [i]:	1:1
	Torque max [Nm]:	32
	Rotation max [1/min]:	8000
	Rotating direction:	same
	Coolant:	IC/Ext
	Pressure max [bar]:	140
	Please note:	Check applicability; note tool length!
	Offset [mm]:	71
8 030 34 016	Angle-mill- and drill holder ER 16 AX UT	
	Weight [kg]:	3.320
	Notation:	180° reversible
	Tool drive:	Flat (~DIN 1809)
	Shank size [mm]:	38.00
	Shank type:	BMT
	Tool adaption:	ER 16 A - u-tec
	Gear ratio [i]:	1:1
	Torque max [Nm]:	20
	Rotation max [1/min]:	8000
	Rotating direction:	opposite
	Coolant:	EXT
	Please note:	Combi bearing
	Center distance [mm]:	59
8 030 34 017	Angle-mill- and drill holder ER 16 AX UT IC	
	Weight [kg]:	3.560
	Notation:	180° reversible
	Tool drive:	Flat (~DIN 1809)
	Shank size [mm]:	38.00
	Shank type:	BMT
	Tool adaption:	ER 16 A - u-tec
	Gear ratio [i]:	1:1
	Torque max [Nm]:	20
	Rotation max [1/min]:	8000
	Rotating direction:	opposite
	Coolant:	IC/Ext

Part-#	Name	
	Pressure max [bar]:	140
	Please note:	Combi bearing
	Center distance [mm]:	59
8 030 34 018	Radial drilling and milling head ER 16 AX UT	
	Weight [kg]:	3.920
	Notation:	180° reversible
	Tool drive:	Flat (~DIN 1809)
	Shank size [mm]:	38.00
	Shank type:	BMT
	Tool adaption:	ER 16 A - u-tec
	Gear ratio [i]:	1:2
	Torque max [Nm]:	6
	Rotation max [1/min]:	12000
	Rotating direction:	same
	Coolant:	EXT
	Center distance [mm]:	73,5
8 030 34 019	Radial drilling and milling head ER 16 AX UT IC	
	Weight [kg]:	3.980
	Notation:	180° reversible
	Tool drive:	Flat (~DIN 1809)
	Shank size [mm]:	38.00
	Shank type:	BMT
	Tool adaption:	ER 16 A - u-tec
	Gear ratio [i]:	1:2
	Torque max [Nm]:	6
	Rotation max [1/min]:	12000
	Rotating direction:	same
	Coolant:	IC/Ext
	Pressure max [bar]:	140
	Center distance [mm]:	73,5
8 030 34 026	Angle-mill- and drill holder ER 20 AX UT	
	Weight [kg]:	3.300
	Notation:	180° reversible
	Tool drive:	Flat (~DIN 1809)
	Shank size [mm]:	38.00
	Shank type:	BMT
	Tool adaption:	ER 20 A - u-tec
	Gear ratio [i]:	1:1
	Torque max [Nm]:	20
	Rotation max [1/min]:	8000
	Rotating direction:	opposite
	Coolant:	EXT
	Please note:	Combi bearing
	Center distance [mm]:	59
8 030 34 028	Angle-mill- and drill holder ER 20 AX UT IC	
	Weight [kg]:	3.550
	Notation:	180° reversible
	Tool drive:	Flat (~DIN 1809)
	Shank size [mm]:	38.00
	Shank type:	BMT
	Tool adaption:	ER 20 A - u-tec
	Gear ratio [i]:	1:1
	Torque max [Nm]:	20

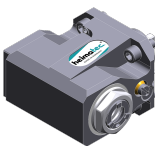
Part-#	Name	
		Rotation max [1/min]: 8000 Rotating direction: opposite Coolant: IC/Ext Pressure max [bar]: 140 Please note: Combi bearing Center distance [mm]: 59
8 030 34 029	Radial drilling and milling head ER 16 AX UT	
	Notation: 180° reversible Tool drive: Flat (~DIN 1809) Shank size [mm]: 38.00 Shank type: BMT Tool adaption: ER 16 A - u-tec Gear ratio [i]: 1:4 Torque max [Nm]: 5 Rotation max [1/min]: 24000 Rotating direction: opposite Coolant: EXT Center distance [mm]: 59	
8 030 34 036	Radial drilling and milling head ER 16 AX UT	
	Weight [kg]: 3.970 Notation: 180° reversible Tool drive: Flat (~DIN 1809) Shank size [mm]: 38.00 Shank type: BMT Tool adaption: ER 16 A - u-tec Gear ratio [i]: 1:3 Torque max [Nm]: 6 Rotation max [1/min]: 18000 Rotating direction: same Coolant: EXT Center distance [mm]: 73,5	
8 030 34 037	Radial drilling and milling head ER 16 AX UT IC	
	Weight [kg]: 3.900 Notation: 180° reversible Tool drive: Flat (~DIN 1809) Shank size [mm]: 38.00 Shank type: BMT Tool adaption: ER 16 A - u-tec Gear ratio [i]: 1:4 Torque max [Nm]: 5 Rotation max [1/min]: 24000 Rotating direction: opposite Coolant: IC/Ext Pressure max [bar]: 140 Center distance [mm]: 59	
8 030 34 045	Radial drilling and milling head ER 20 AX UT IC	
	Weight [kg]: 3.520 Notation: 180° reversible Tool drive: Flat (~DIN 1809) Shank size [mm]: 38.00 Shank type: BMT Tool adaption: ER 20 A - u-tec	

Part-#	Name
--------	------

Gear ratio [i]: 1:1
 Torque max [Nm]: 20
 Rotation max [1/min]: 12000
 Rotating direction: opposite
 Coolant: IC/Ext
 Pressure max [bar]: 140
 Center distance [mm]: 59

8 030 34 046 Radial drilling and milling head ER 20 AX UT

Weight [kg]: 3.270
 Notation: 180° reversible
 Tool drive: Flat (~DIN 1809)
 Shank size [mm]: 38.00
 Shank type: BMT
 Tool adaption: ER 20 A - u-tec
 Gear ratio [i]: 1:1
 Torque max [Nm]: 20
 Rotation max [1/min]: 12000
 Rotating direction: opposite
 Coolant: EXT
 Center distance [mm]: 59

8 030 34 048 Radial drilling and milling head ER 16 AX UT IC

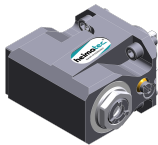

Weight [kg]: 3.540
 Notation: 180° reversible
 Tool drive: Flat (~DIN 1809)
 Shank size [mm]: 38.00
 Shank type: BMT
 Tool adaption: ER 16 A - u-tec
 Gear ratio [i]: 1:1
 Torque max [Nm]: 20
 Rotation max [1/min]: 12000
 Rotating direction: opposite
 Coolant: IC/Ext
 Pressure max [bar]: 140
 Center distance [mm]: 59

8 030 34 049 Radial drilling and milling head ER 16 AX UT

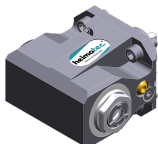

Weight [kg]: 3.280
 Notation: 180° reversible
 Tool drive: Flat (~DIN 1809)
 Shank size [mm]: 38.00
 Shank type: BMT
 Tool adaption: ER 16 A - u-tec
 Gear ratio [i]: 1:1
 Torque max [Nm]: 20
 Rotation max [1/min]: 12000
 Rotating direction: opposite
 Coolant: EXT
 Center distance [mm]: 59

Part-#	Name
--------	------

8 030 35 031

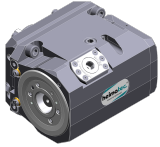

Radial drilling and milling head C 3 IC

Weight [kg]: 6.790
 Notation: 180° reversible
 Tool drive: Flat (~DIN 1809)
 Shank size [mm]: 38.00
 Shank type: BMT
 Tool adaption: heimatec Capto(TM) C 3
 Gear ratio [i]: 1:1
 Torque max [Nm]: 25
 Rotation max [1/min]: 8000
 Rotating direction: opposite
 Coolant: IC/Ext
 Pressure max [bar]: 140
 Please note: Check applicability; note tool length!
 Center distance [mm]: 65

8 030 35 032



Radial drilling and milling head C 3 IC

Weight [kg]: 6.180
 Notation: 180° reversible
 Tool drive: Flat (~DIN 1809)
 Shank size [mm]: 38.00
 Shank type: BMT
 Tool adaption: heimatec Capto(TM) C 3
 Gear ratio [i]: 1:1
 Torque max [Nm]: 25
 Rotation max [1/min]: 8000
 Rotating direction: opposite
 Coolant: IC/Ext
 Pressure max [bar]: 140
 Please note: Check applicability; note tool length!
 Center distance [mm]: 65

8 031 34 003

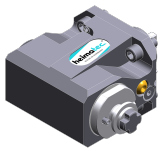

Radial polygon head arbor 16

Weight [kg]: 3.420
 Notation: 180° reversible
 Tool drive: Flat (~DIN 1809)
 Shank size [mm]: 38.00
 Shank type: BMT
 Tool adaption: Polygon arbor 16
 Gear ratio [i]: 1:1
 Torque max [Nm]: 20
 Rotation max [1/min]: 6000
 Rotating direction: opposite
 Coolant: EXT
 Please note: Combi bearing
 Center distance [mm]: 59

8 033 34 003

Radial drilling and milling head ER 16 AX UT

Weight [kg]: 3.960
 Notation: offset
 Employment for: Sub spindle
 Tool drive: Flat (~DIN 1809)
 Shank size [mm]: 38.00
 Shank type: BMT
 Tool adaption: ER 16 A - u-tec
 Gear ratio [i]: 1:1
 Torque max [Nm]: 20

Part-#	Name
--------	------

Rotation max [1/min]:	6000
Rotating direction:	same
Coolant:	EXT
Please note:	Combi bearing
Center distance [mm]:	59

8 033 34 004 Radial drilling and milling head ER 16 AX UT IC

Weight [kg]:	4.360
Notation:	offset
Employment for:	Sub spindle
Tool drive:	Flat (~DIN 1809)
Shank size [mm]:	38.00
Shank type:	BMT
Tool adaption:	ER 16 A - u-tec
Gear ratio [i]:	1:1
Torque max [Nm]:	20
Rotation max [1/min]:	6000
Rotating direction:	same
Coolant:	IC/Ext
Pressure max [bar]:	140
Please note:	Combi bearing
Center distance [mm]:	59



8 033 34 007 Radial drilling and milling head ER 20 AX UT

Weight [kg]:	4.070
Notation:	offset
Employment for:	Sub spindle
Tool drive:	Flat (~DIN 1809)
Shank size [mm]:	38.00
Shank type:	BMT
Tool adaption:	ER 20 A - u-tec
Gear ratio [i]:	1:1
Torque max [Nm]:	20
Rotation max [1/min]:	6000
Rotating direction:	same
Coolant:	EXT
Please note:	Combi bearing
Center distance [mm]:	59

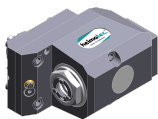
8 033 34 008 Radial drilling and milling head ER 20 AX UT IC



Weight [kg]:	4.240
Notation:	offset
Employment for:	Sub spindle
Tool drive:	Flat (~DIN 1809)
Shank size [mm]:	38.00
Shank type:	BMT
Tool adaption:	ER 20 A - u-tec
Gear ratio [i]:	1:1
Torque max [Nm]:	20
Rotation max [1/min]:	6000
Rotating direction:	same
Coolant:	IC/Ext
Pressure max [bar]:	140
Please note:	Combi bearing
Center distance [mm]:	59

Part-#	Name	
8 033 34 009	Radial drilling and milling head ER 16 AX UT IC	
	Weight [kg]:	4.340
	Notation:	offset
	Employment for:	Sub spindle
	Tool drive:	Flat (~DIN 1809)
	Shank size [mm]:	38.00
	Shank type:	BMT
	Tool adaption:	ER 16 A - u-tec
	Gear ratio [i]:	1:2
	Torque max [Nm]:	12
	Rotation max [1/min]:	12000
	Rotating direction:	same
	Coolant:	IC/Ext
	Pressure max [bar]:	140
	Center distance [mm]:	59
8 033 34 010	Radial drilling and milling head ER 16 AX UT	
	Notation:	offset
	Tool drive:	Flat (~DIN 1809)
	Shank size [mm]:	38.00
	Shank type:	BMT
	Tool adaption:	ER 16 A - u-tec
	Gear ratio [i]:	1:2
	Torque max [Nm]:	12
	Rotation max [1/min]:	12000
	Rotating direction:	same
	Coolant:	EXT
	Center distance [mm]:	59
8 037 31 000	Radial disk mill head arbor 8	
	Weight [kg]:	3.720
	Notation:	180° reversible
	Tool drive:	Flat (~DIN 1809)
	Shank size [mm]:	38.00
	Shank type:	BMT
	Tool adaption:	Arbor 8
	Gear ratio [i]:	2:1
	Torque max [Nm]:	20
	Rotation max [1/min]:	3000
	Rotating direction:	opposite
	Coolant:	EXT
	Please note:	Check applicability!
	Center distance [mm]:	65
8 037 33 002	Radial disk mill head arbor 13	
	Weight [kg]:	3.780
	Notation:	180° reversible
	Version:	0° position can be pinned
	Tool drive:	Flat (~DIN 1809)
	Shank size [mm]:	38.00
	Shank type:	BMT
	Tool adaption:	Arbor 13
	Gear ratio [i]:	2:1
	Torque max [Nm]:	20
	Rotation max [1/min]:	3000
	Rotating direction:	opposite
	Coolant:	EXT

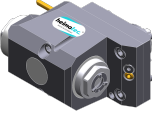
Part-#	Name	
	Please note:	Check applicability!
	Center distance [mm]:	65
8 037 34 003	Woodruff keycutter ER 16 AX UT	
	Weight [kg]:	3.300
	Notation:	180° reversible
	Tool drive:	Flat (~DIN 1809)
	Shank size [mm]:	38.00
	Shank type:	BMT
	Tool adaption:	ER 16 A - u-tec
	Gear ratio [i]:	2:1
	Torque max [Nm]:	20
	Rotation max [1/min]:	3000
	Rotating direction:	opposite
	Coolant:	EXT
	Center distance [mm]:	65
8 037 34 007	Radial disk mill head arbor 16	
	Weight [kg]:	3.880
	Notation:	180° reversible
	Version:	0° position can be pinned
	Tool drive:	Flat (~DIN 1809)
	Shank size [mm]:	38.00
	Shank type:	BMT
	Tool adaption:	Arbor 16
	Gear ratio [i]:	2:1
	Torque max [Nm]:	20
	Rotation max [1/min]:	3000
	Rotating direction:	opposite
	Coolant:	EXT
	Please note:	Check applicability!
	Center distance [mm]:	65
8 039 34 006	Radial drilling and milling head ER 16 AX UT	
	Weight [kg]:	2.800
	Notation:	180° reversible
	Version:	double spindle
	Tool drive:	Flat (~DIN 1809)
	Shank size [mm]:	38.00
	Shank type:	BMT
	Tool adaption:	ER 16 u-tec
	Gear ratio [i]:	1:1
	Torque max [Nm]:	20
	Rotation max [1/min]:	12000
	Rotating direction:	same/opposite
	Coolant:	EXT
	Please note:	stronger bearing
	Center distance [mm]:	59
8 039 34 007	Radial drilling and milling head ER 16 AX UT	
	Weight [kg]:	4.370
	Notation:	offset
	Employment for:	Main- and sub spindle
	Version:	double spindle
	Tool drive:	Flat (~DIN 1809)
	Shank size [mm]:	38.00

Part-#	Name	
	Shank type:	BMT
	Tool adaption:	ER 16 A - u-tec
	Gear ratio [i]:	1:1
	Torque max [Nm]:	20
	Rotation max [1/min]:	6000
	Rotating direction:	same/opposite
	Coolant:	EXT
	Please note:	stronger bearing
	Center distance [mm]:	59
8 039 34 012	Radial drilling and milling head ER 20 AX UT	
	Notation:	180° reversible
	Version:	double spindle
	Tool drive:	Flat (~DIN 1809)
	Shank size [mm]:	38.00
	Shank type:	BMT
	Tool adaption:	ER 20 A - u-tec
	Gear ratio [i]:	1:1
	Torque max [Nm]:	20
	Rotation max [1/min]:	12000
	Rotating direction:	same/opposite
	Coolant:	EXT
	Please note:	stronger bearing
	Center distance [mm]:	59
8 039 34 013	Radial drilling and milling head ER 20 AX UT	
	Weight [kg]:	4.260
	Notation:	offset
	Employment for:	Main- and sub spindle
	Version:	double spindle
	Tool drive:	Flat (~DIN 1809)
	Shank size [mm]:	38.00
	Shank type:	BMT
	Tool adaption:	ER 20 A - u-tec
	Gear ratio [i]:	1:1
	Torque max [Nm]:	20
	Rotation max [1/min]:	6000
	Rotating direction:	same/opposite
	Coolant:	EXT
	Please note:	stronger bearing
	Center distance [mm]:	59
8 039 34 014	Radial drilling and milling head ER 16 AX UT	
	Weight [kg]:	4.270
	Employment for:	Main- and sub spindle
	Version:	double spindle
	Tool drive:	Flat (~DIN 1809)
	Shank size [mm]:	38.00
	Shank type:	BMT
	Tool adaption:	ER 16 A - u-tec
	Gear ratio [i]:	1:1
	Torque max [Nm]:	20/Sp.
	Rotation max [1/min]:	6000
	Rotating direction:	same
	Coolant:	EXT
	Please note:	stronger bearing
	Center distance [mm]:	45/80

Part-#	Name
--------	------

8 039 34 015	Radial drilling and milling head ER 16 AX UT IC
Weight [kg]:	4.620
Employment for:	Main- and sub spindle
Version:	double spindle
Tool drive:	Flat (~DIN 1809)
Shank size [mm]:	38.00
Shank type:	BMT
Tool adaption:	ER 16 A - u-tec
Gear ratio [i]:	1:1
Torque max [Nm]:	20/Sp.
Rotation max [1/min]:	6000
Rotating direction:	same
Coolant:	IC/Ext
Pressure max [bar]:	140
Please note:	stronger bearing
Center distance [mm]:	45/80

8 039 34 018	Radial drilling and milling head ER 16 AX UT
Weight [kg]:	4.370
Notation:	offset
Employment for:	Main- and sub spindle
Version:	double spindle
Tool drive:	Flat (~DIN 1809)
Shank size [mm]:	38.00
Shank type:	BMT
Tool adaption:	ER 16 A - u-tec
Gear ratio [i]:	1:2
Torque max [Nm]:	12
Rotation max [1/min]:	12000
Rotating direction:	same
Coolant:	EXT
Please note:	stronger bearing
Center distance [mm]:	59

8 039 35 008	Radial drilling and milling head C 3
Weight [kg]:	7.675
Notation:	180° reversible
Employment for:	Main- and sub spindle
Version:	double spindle
Tool drive:	Flat (~DIN 1809)
Shank size [mm]:	38.00
Shank type:	BMT
Tool adaption:	heimatec Capto(TM) C 3
Gear ratio [i]:	1:1
Torque max [Nm]:	25
Rotation max [1/min]:	8000
Rotating direction:	same/opposite
Coolant:	EXT
Please note:	Check applicability; note tool length!
Center distance [mm]:	65



Part-#	Name
--------	------

8 043 34 002



Universal head +105°/-20° adj. ER16 AX UT

Notation:	offset
Employment for:	Main spindle
Tool drive:	Flat (~DIN 1809)
Shank size [mm]:	38.00
Shank type:	BMT
Tool adaption:	ER 16 A - u-tec
Gear ratio [i]:	1:1
Torque max [Nm]:	20
Rotation max [1/min]:	6000
Rotating direction:	opposite
Coolant:	EXT
Pressure max [bar]:	140
Center distance [mm]:	50
Offset [mm]:	35

8 043 34 003

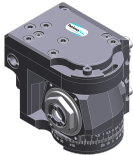

Universal head +105°/-20° adj. ER16AX UTIK

Notation:	offset
Employment for:	Main spindle
Tool drive:	Flat (~DIN 1809)
Shank size [mm]:	38.00
Shank type:	BMT
Tool adaption:	ER 16 A - u-tec
Gear ratio [i]:	1:1
Torque max [Nm]:	20
Rotation max [1/min]:	6000
Rotating direction:	opposite
Coolant:	IC/Ext
Pressure max [bar]:	25
Center distance [mm]:	50
Offset [mm]:	35

8 043 34 004

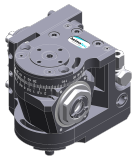

Universal head +105°/-20° adj. ER16 AX UT

Notation:	offset
Employment for:	Main spindle
Tool drive:	Flat (~DIN 1809)
Shank size [mm]:	38.00
Shank type:	BMT
Tool adaption:	ER 16 A - u-tec
Gear ratio [i]:	1:2
Torque max [Nm]:	6
Rotation max [1/min]:	12000
Rotating direction:	opposite
Coolant:	EXT
Center distance [mm]:	50
Offset [mm]:	35

8 043 34 005

Universal head +105°/-20° adj. ER16AX UTIK

Notation:	offset
Employment for:	Main spindle
Tool drive:	Flat (~DIN 1809)
Shank size [mm]:	38.00
Shank type:	BMT
Tool adaption:	ER 16 A - u-tec
Gear ratio [i]:	1:2
Torque max [Nm]:	6
Rotation max [1/min]:	12000

Part-#	Name
--------	------

Rotating direction:	opposite
Coolant:	IC/Ext
Pressure max [bar]:	25
Center distance [mm]:	50
Offset [mm]:	35

8 043 34 006 Universal head +120°/-40° adj. ER16 AX UT

Weight [kg]:	4.790
Notation:	offset
Employment for:	Main spindle
Version:	Special
Tool drive:	Flat (~DIN 1809)
Shank size [mm]:	38.00
Shank type:	BMT
Tool adaption:	ER 16 A - u-tec
Gear ratio [i]:	1:1
Torque max [Nm]:	20
Rotation max [1/min]:	6000
Rotating direction:	opposite
Coolant:	EXT
Center distance [mm]:	50
Offset [mm]:	35

8 043 34 012 Universal head +110°/-90° adj. ER16 AX UT



Notation:	offset; 180° reversible
Employment for:	Main- and sub spindle
Version:	Special
Tool drive:	Flat (~DIN 1809)
Shank size [mm]:	38.00
Shank type:	BMT
Tool adaption:	ER 16 A - u-tec
Gear ratio [i]:	1:2
Torque max [Nm]:	6
Rotation max [1/min]:	12000
Rotating direction:	opposite
Coolant:	EXT
Pressure max [bar]:	140
Please note:	Note swivel range!
Center distance [mm]:	66
Offset [mm]:	15

8 043 34 019 Universal head - 30°/-90° adj. ER16AX UTIK



Notation:	offset; 180° reversible
Employment for:	Main- and sub spindle
Version:	Special
Tool drive:	Flat (~DIN 1809)
Shank size [mm]:	38.00
Shank type:	BMT
Tool adaption:	ER 16 A - u-tec
Gear ratio [i]:	1:2
Torque max [Nm]:	6
Rotation max [1/min]:	12000
Rotating direction:	opposite
Coolant:	IC/Ext
Pressure max [bar]:	140
Please note:	Note swivel range!
Center distance [mm]:	66

Part-#	Name
--------	------

Offset [mm]: 15

8 050 34 000



Multispindle drilling head ER 16 AX UT
 Weight [kg]: 3.400
 Version: 2-spindles
 Tool drive: Flat (~DIN 1809)
 Shank size [mm]: 38.00
 Shank type: BMT
 Tool adaption: ER 16 A - u-tec
 Gear ratio [i]: 1:1
 Torque max [Nm]: 16/Sp.
 Rotation max [1/min]: 6000
 Rotating direction: same
 Coolant: EXT
 Offset [mm]: 60

8 050 34 001

Multispindle drilling head ER 16 AX UT IC
 Weight [kg]: 3.580
 Version: 2-spindles
 Tool drive: Flat (~DIN 1809)
 Shank size [mm]: 38.00
 Shank type: BMT
 Tool adaption: ER 16 A - u-tec
 Gear ratio [i]: 1:1
 Torque max [Nm]: 16/Sp.
 Rotation max [1/min]: 6000
 Rotating direction: same
 Coolant: IC/Ext
 Pressure max [bar]: 140
 Offset [mm]: 60

8 050 34 002



Multispindle drilling head ER 16 AX UT
 Weight [kg]: 3.250
 Notation: 180° reversible
 Version: 2-spindles
 Tool drive: Flat (~DIN 1809)
 Shank size [mm]: 38.00
 Shank type: BMT
 Tool adaption: ER 16 A - u-tec
 Gear ratio [i]: 1:1
 Torque max [Nm]: 20/Sp.
 Rotation max [1/min]: 6000
 Rotating direction: opposite
 Coolant: EXT
 Offset [mm]: ±34,5

8 050 34 003

Multispindle drilling head ER 16 AX UT IC
 Weight [kg]: 4.130
 Notation: 180° reversible
 Version: 2-spindles
 Tool drive: Flat (~DIN 1809)
 Shank size [mm]: 38.00
 Shank type: BMT
 Tool adaption: ER 16 A - u-tec
 Gear ratio [i]: 1:1
 Torque max [Nm]: 20/Sp.
 Rotation max [1/min]: 6000

Part-#	Name	
	Rotating direction:	opposite
	Coolant:	IC/Ext
	Pressure max [bar]:	140
	Offset [mm]:	+34,5/-34,5
8 050 34 004	Multispindle drilling head ER 16 AX UT	
	Weight [kg]:	3.410
	Version:	3-spindles
	Tool drive:	Flat (~DIN 1809)
	Shank size [mm]:	38.00
	Shank type:	BMT
	Tool adaption:	ER 16 A - u-tec
	Gear ratio [i]:	1:1
	Torque max [Nm]:	16/Sp.
	Rotation max [1/min]:	6000
	Rotating direction:	same
	Coolant:	EXT
	Please note:	2xER 16A UT offset, 1x centre of shank
8 050 34 005	Multispindle drilling head ER 16 AX UT	
	Weight [kg]:	3.160
	Notation:	180° reversible
	Version:	2-spindles
	Tool drive:	Flat (~DIN 1809)
	Shank size [mm]:	38.00
	Shank type:	BMT
	Tool adaption:	ER 16 A - u-tec
	Gear ratio [i]:	1:2
	Torque max [Nm]:	6/Sp.
	Rotation max [1/min]:	12000
	Rotating direction:	opposite
	Coolant:	EXT
	Offset [mm]:	+34,5/-34,5
8 050 34 007	Multispindle drilling head ER 16 AX UT IC	
	Weight [kg]:	3.590
	Version:	3-spindles
	Tool drive:	Flat (~DIN 1809)
	Shank size [mm]:	38.00
	Shank type:	BMT
	Tool adaption:	ER 16 A - u-tec
	Gear ratio [i]:	1:1
	Torque max [Nm]:	16/Sp.
	Rotation max [1/min]:	6000
	Rotating direction:	same
	Coolant:	IC/Ext
	Pressure max [bar]:	140
	Please note:	2x ER16A UT offset; 1x centre of shank
	Offset [mm]:	60
8 050 34 009	Multispindle drilling head ER 16 AX UT IC	
	Weight [kg]:	3.610
	Version:	2-spindles
	Tool drive:	Flat (~DIN 1809)
	Shank size [mm]:	38.00
	Shank type:	BMT
	Tool adaption:	ER 16 A - u-tec

Part-#	Name	
	Gear ratio [i]:	1:2
	Torque max [Nm]:	8/Sp.
	Rotation max [1/min]:	12000
	Rotating direction:	same
	Coolant:	IC/Ext
	Pressure max [bar]:	140
	Offset [mm]:	60
8 050 34 011	Multispindle drilling head ER 16 AX UT IC	
	Weight [kg]:	3.600
	Version:	2-spindles
	Tool drive:	Flat (~DIN 1809)
	Shank size [mm]:	38.00
	Shank type:	BMT
	Tool adaption:	ER 16 A - u-tec
	Gear ratio [i]:	1:1
	Torque max [Nm]:	16/Sp.
	Rotation max [1/min]:	6000
	Rotating direction:	same
	Coolant:	IC air
	Pressure max [bar]:	10
	Offset [mm]:	60
8 053 34 000	Multispindle radial head ER 16 AX UT	
	Weight [kg]:	4.560
	Employment for:	Main spindle
	Version:	2-spindles
	Tool drive:	Flat (~DIN 1809)
	Shank size [mm]:	38.00
	Shank type:	BMT
	Tool adaption:	ER 16 A - u-tec
	Gear ratio [i]:	1:1
	Torque max [Nm]:	20
	Rotation max [1/min]:	6000
	Rotating direction:	same/opposite
	Coolant:	EXT
	Please note:	stronger bearing
	Center distance [mm]:	37/72
8 053 34 001	Multispindle radial head ER 16AX UT IC	
	Weight [kg]:	4.980
	Employment for:	Main spindle
	Version:	2-spindles
	Tool drive:	Flat (~DIN 1809)
	Shank size [mm]:	38.00
	Shank type:	BMT
	Tool adaption:	ER 16 A - u-tec
	Gear ratio [i]:	1:1
	Torque max [Nm]:	20
	Rotation max [1/min]:	6000
	Rotating direction:	same/opposite
	Coolant:	IC/Ext
	Pressure max [bar]:	140
	Please note:	stronger bearing
	Center distance [mm]:	37/72

Part-#	Name
--------	------

8 053 34 002



Multispindle radial head ER 16 AX UT

Weight [kg]: 7.110
 Employment for: Main spindle
 Version: 4-spindles
 Tool drive: Flat (~DIN 1809)
 Shank size [mm]: 38.00
 Shank type: BMT
 Tool adaption: ER 16 A - u-tec
 Gear ratio [i]: 1:1
 Torque max [Nm]: 16
 Rotation max [1/min]: 6000
 Rotating direction: same
 Coolant: EXT
 Please note: stronger bearing
 Center distance [mm]: 45/80

8 053 34 003



Multispindle radial head ER 16AX UT IC

Weight [kg]: 7.660
 Employment for: Main spindle
 Version: 4-spindles
 Tool drive: Flat (~DIN 1809)
 Shank size [mm]: 38.00
 Shank type: BMT
 Tool adaption: ER 16 A - u-tec
 Gear ratio [i]: 1:1
 Torque max [Nm]: 16
 Rotation max [1/min]: 6000
 Rotating direction: same
 Coolant: IC/Ext
 Pressure max [bar]: 140
 Please note: stronger bearing
 Center distance [mm]: 45/80

8 053 34 004

Multispindle radial head ER 16 AX UT

Weight [kg]: 4.910
 Employment for: Main spindle
 Version: 2-spindles
 Tool drive: Flat (~DIN 1809)
 Shank size [mm]: 38.00
 Shank type: BMT
 Tool adaption: ER 16 A - u-tec
 Gear ratio [i]: 1:1
 Torque max [Nm]: 20
 Rotation max [1/min]: 6000
 Rotating direction: same/opposite
 Coolant: EXT
 Please note: stronger bearing
 Center distance [mm]: 45/80

8 053 34 005

Multispindle radial head ER 16AX UT IC

Weight [kg]: 5.510
 Employment for: Main spindle
 Version: 2-spindles
 Tool drive: Flat (~DIN 1809)
 Shank size [mm]: 38.00
 Shank type: BMT
 Tool adaption: ER 16 A - u-tec

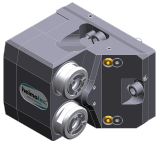
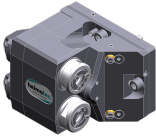
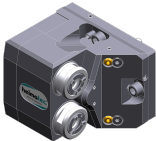
Part-#	Name	
		Gear ratio [i]: 1:1 Torque max [Nm]: 20 Rotation max [1/min]: 6000 Rotating direction: same/opposite Coolant: IC/Ext Pressure max [bar]: 140 Please note: stronger bearing Center distance [mm]: 45/80
8 053 34 009	Multispindle radial head ER 16 AX UT	 Weight [kg]: 5.520 Notation: 180° reversible Employment for: Main- and sub spindle Version: 2-spindles; offset Tool drive: Flat (~DIN 1809) Shank size [mm]: 38.00 Shank type: BMT Tool adaption: ER 16 A - u-tec Gear ratio [i]: 1:1 Torque max [Nm]: 16 Rotation max [1/min]: 6000 Rotating direction: same Coolant: EXT Please note: stronger bearing Center distance [mm]: 80
8 053 34 010	Multispindle radial head ER16 AX UT IC	 Weight [kg]: 5.740 Notation: 180° reversible Employment for: Main- and sub spindle Version: 2-spindles; offset Tool drive: Flat (~DIN 1809) Shank size [mm]: 38.00 Shank type: BMT Tool adaption: ER 16 A - u-tec Gear ratio [i]: 1:1 Torque max [Nm]: 16 Rotation max [1/min]: 6000 Rotating direction: same Coolant: IC/Ext Pressure max [bar]: 140 Please note: stronger bearing Center distance [mm]: 80
8 053 34 011	Multispindle radial head ER 16 AX UT	 Weight [kg]: 5.540 Notation: 180° reversible Employment for: Main- and sub spindle Version: 2-spindles; offset Tool drive: Flat (~DIN 1809) Shank size [mm]: 38.00 Shank type: BMT Tool adaption: ER 16 A - u-tec Gear ratio [i]: 1:2 Torque max [Nm]: 8 Rotation max [1/min]: 12000 Rotating direction: same

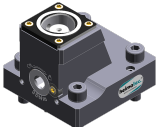
Part-#	Name	
	Coolant:	EXT
	Please note:	stronger bearing
	Center distance [mm]:	80
8 068 34 000	Radial whirling unit HW 46	
	Weight [kg]:	4.100
	Notation:	180° reversible
	Tool drive:	Flat (~DIN 1809)
	Shank size [mm]:	38.00
	Shank type:	BMT
	Tool adaption:	HW 46
	Gear ratio [i]:	1:1
	Torque max [Nm]:	16
	Rotation max [1/min]:	8000
	Rotating direction:	same
	Coolant:	no
	Center distance [mm]:	65
8 200 02 000	Cover plate	
	Weight [kg]:	0.248
	Shank type:	-
8 202 00 012	Basic holder longitudinal seat FN 12	
	Weight [kg]:	0.860
	Notation:	180° reversible
	Shank type:	BMT
	Machine adaption:	Centering bolt ø 12
	Tool adaption:	Interface FN 12
	Coolant:	EXT
8 224 04 071	Universal turning holder sq. 20 IC	
	Notation:	180° reversible
	Shank type:	BMT
	Machine adaption:	Centering bolt ø 12
	Tool adaption:	Sq. 20
		Sq. 20
	Coolant:	IC/Ext
	Pressure max [bar]:	140
	Please note:	Key rail
8 229 05 008	Tool holder C 3 IC	
	Weight [kg]:	1.360
	Notation:	180° reversible
	Version:	right
	Shank type:	BMT
	Machine adaption:	Centering bolt ø 12
	Tool adaption:	heimatec Capto(TM) C 3
	Coolant:	IC
	Please note:	Check applicability; note tool length!
	Offset [mm]:	20

Part-#	Name	
8 229 05 011	Tool holder C 3 IC	
	Weight [kg]:	2.520
	Notation:	180° reversible
	Version:	right
	Shank type:	BMT
	Machine adaption:	Centering bolt ø 12
	Tool adaption:	heimatec Capto(TM) C 3
	Coolant:	IC
	Please note:	Check applicability; note tool length!
	Offset [mm]:	54
8 229 34 000	Adapter for sensor Blum TC 54-10 T	
	Weight [kg]:	0.530
	Shank size [mm]:	38.00
	Shank type:	BMT
	Tool adaption:	Blum TC54-10T
8 240 05 067	Tool holder C 3 IC	
	Weight [kg]:	3.250
	Notation:	180° reversible
	Version:	right
	Shank type:	BMT
	Machine adaption:	Centering bolt ø 12
	Tool adaption:	heimatec Capto(TM) C 3
	Coolant:	IC
	Please note:	Check applicability; note tool length!
	Center distance [mm]:	75
8 240 05 068	Tool holder C 3 IC	
	Weight [kg]:	2.790
	Notation:	180° reversible
	Version:	offset; right
	Shank type:	BMT
	Machine adaption:	Centering bolt ø 12
	Tool adaption:	heimatec Capto(TM) C 3
	Coolant:	IC
	Please note:	Check applicability; note tool length!
	Center distance [mm]:	75
8 240 08 035	Boring bar holder Ø 32	
	Weight [kg]:	2.840
	Notation:	offset, 180° reversible
	Shank type:	BMT
	Machine adaption:	Centering bolt ø 12
	Tool adaption:	Ø 32
	Coolant:	IC/Ext
	Center distance [mm]:	60
8 249 05 010	Double tool holder C 3 IC	
	Employment for:	Main- and sub spindle
	Version:	right
	Shank type:	BMT
	Machine adaption:	Centering bolt ø 12
	Tool adaption:	heimatec Capto(TM) C 3 heimatec Capto(TM) C 3
	Coolant:	IC

Part-#	Name	
	Please note:	Check applicability; note tool length!
	Center distance [mm]:	75
8 250 05 005	Multiple tool holder C 3 IC	
	Employment for:	Main- and sub spindle
	Version:	right
	Shank type:	BMT
	Machine adaption:	Centering bolt \varnothing 12
	Tool adaption:	heimatec Capto(TM) C 3
		heimatec Capto(TM) C 3
	Coolant:	IC
	Please note:	Check applicability; note tool length!
	Offset [mm]:	20
		20
8 250 05 009	Multiple tool holder C 3 IC	
	Employment for:	Main- and sub spindle
	Version:	right
	Shank type:	BMT
	Machine adaption:	Centering bolt \varnothing 12
	Tool adaption:	heimatec Capto(TM) C 3
		heimatec Capto(TM) C 3
	Coolant:	IC
	Please note:	Check applicability; note tool length!
	Offset [mm]:	54
		54
8 251 01 000	Multiple turning holder sq. 16	
	Weight [kg]:	3.800
	Employment for:	Main- and sub spindle
	Shank type:	BMT
	Machine adaption:	Centering bolt \varnothing 12
	Tool adaption:	Sq. 16
		Sq. 16
	Coolant:	EXT
	Please note:	no coolant at 15°
8 251 01 002	Multiple turning holder sq. 5/8"	
	Weight [kg]:	3.810
	Employment for:	Main- and sub spindle
	Shank type:	BMT
	Machine adaption:	Centering bolt \varnothing 12
	Tool adaption:	Sq. 5/8" (15,875mm)
		Sq. 5/8" (15,875mm)
	Coolant:	EXT
	Please note:	no coolant at 15°
8 253 07 008	Multiple boring bar holder \varnothing 25	
	Weight [kg]:	3.170
	Notation:	offset
	Shank type:	BMT
	Machine adaption:	Centering bolt \varnothing 12
	Tool adaption:	\varnothing 25
		\varnothing 25
	Coolant:	IC/Ext
	Please note:	no coolant at 15°

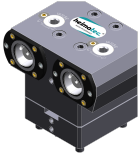
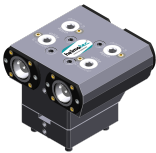
Part-#	Name	
	Center distance [mm]:	44/79
8 253 07 018	Multiple boring bar holder Ø 1"	
	Weight [kg]:	3.180
	Notation:	offset
	Shank type:	BMT
	Machine adaption:	Centering bolt ø 12
	Tool adaption:	Ø 1" (25,4mm)
		Ø 1" (25,4mm)
	Coolant:	IC/Ext
	Please note:	no coolant at 15°
	Center distance [mm]:	44/79
8 253 07 048	Multiple boring bar holder Ø 25	
	Weight [kg]:	2.810
	Notation:	offset
	Employment for:	Main- and sub spindle
	Shank type:	BMT
	Machine adaption:	Centering bolt ø 12
	Tool adaption:	Ø 25
		Ø 25
	Coolant:	IC/Ext
	Center distance [mm]:	44/79
8 259 05 013	Multiple tool holder C 3 IC	
	Notation:	180° reversible
	Version:	right; Y-axes offset
	Shank type:	BMT
	Machine adaption:	Centering bolt ø 12
	Tool adaption:	heimatec Capto(TM) C 3
		heimatec Capto(TM) C 3
	Coolant:	IC
	Please note:	Check applicability; note tool length!
	Center distance [mm]:	75
8 259 05 014	Multiple tool holder C 3 IC	
	Notation:	180° reversible
	Version:	right; offset; Y-axes offset
	Shank type:	BMT
	Machine adaption:	Centering bolt ø 12
	Tool adaption:	heimatec Capto(TM) C 3
		heimatec Capto(TM) C 3
	Coolant:	IC
	Please note:	Check applicability; note tool length!
	Center distance [mm]:	75
8 259 05 015	Multiple tool holder C 3 IC	
	Employment for:	Main- and sub spindle
	Version:	right; Y-axes offset
	Shank type:	BMT
	Machine adaption:	Centering bolt ø 12
	Tool adaption:	heimatec Capto(TM) C 3
		heimatec Capto(TM) C 3
		heimatec Capto(TM) C 3
		heimatec Capto(TM) C 3
	Coolant:	IC

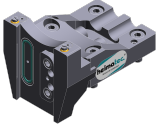
Part-#	Name	
	Please note: Center distance [mm]:	Check applicability; note tool length! 75
8 259 05 022	Multiple tool holder C 3 IC	
	Weight [kg]: Employment for: Version: Shank type: Machine adaption: Tool adaption:	4.630 Main- and sub spindle right; Y-axes offset BMT Centering bolt ø 12 heimatec Capto(TM) C 3 heimatec Capto(TM) C 3 heimatec Capto(TM) C 3 heimatec Capto(TM) C 3
	Coolant: Please note: Offset [mm]:	IC Check applicability; note tool length! not 54 54
8 320 02 011	Cut-off holder, height adjustable SH 26 IC	
	Weight [kg]: Notation: Shank type: Machine adaption: Tool adaption: Coolant: Pressure max [bar]:	1.370 180° reversible BMT Centering bolt ø 12 Clampshaft SH 26 IC/Ext 70
8 320 02 016	Cut-off holder, height adjustable SH 26 IC	
	Weight [kg]: Notation: Shank type: Machine adaption: Tool adaption: Coolant: Pressure max [bar]: Please note:	1.450 180° reversible BMT Centering bolt ø 12 Clampshaft SH 26 IC/Ext 70 Clampshaft internal
8 320 03 019	Cut-off holder, height adjustable SH 32 IC	
	Weight [kg]: Version: Shank type: Machine adaption: Tool adaption: Coolant: Pressure max [bar]: Please note:	1.720 Special BMT Centering bolt ø 12 Clampshaft SH 32 IC/Ext 70 with offset cut-off tool holder
8 320 03 021	Cut-off holder, height adjustable SH 32 IC	
	Weight [kg]: Shank type: Machine adaption: Tool adaption: Coolant: Pressure max [bar]:	1.470 BMT Centering bolt ø 12 Clampshaft SH 32 IC/Ext 70

Part-#	Name	
8 320 03 026	Cut-off holder, height adjustable SH 32 IC	
	Weight [kg]:	1.620
	Notation:	180° reversible
	Shank type:	BMT
	Machine adaption:	Centering bolt ø 12
	Tool adaption:	Clampshaft SH 32
	Coolant:	IC/Ext
	Pressure max [bar]:	70
	Please note:	Clampshaft internal
8 320 09 002	Cut-off holder, height adjustable 845 IC	
	Weight [kg]:	1.380
	Notation:	180° reversible
	Shank type:	BMT
	Machine adaption:	Centering bolt ø 12
	Tool adaption:	 System 845
	Coolant:	IC
	Pressure max [bar]:	70

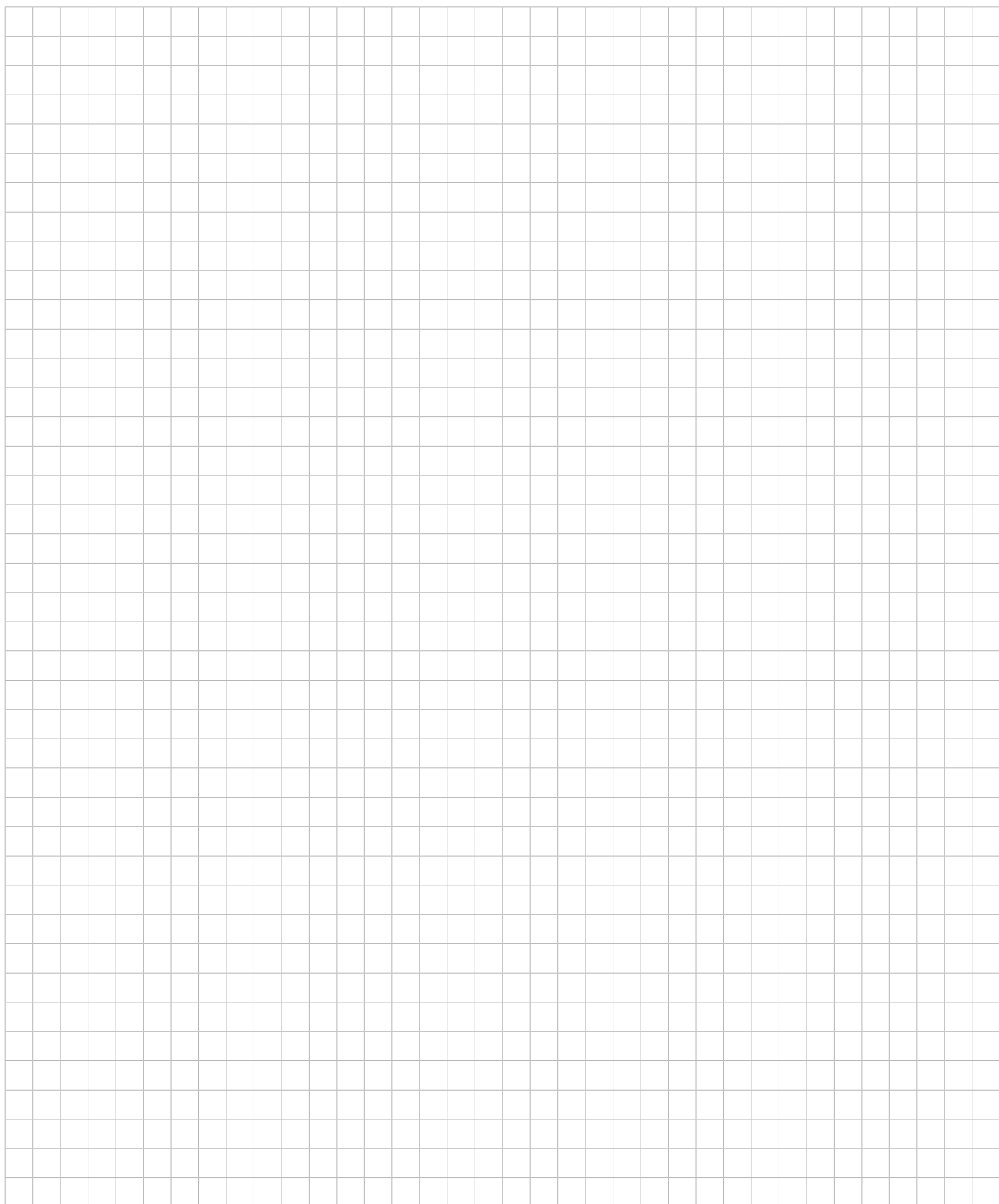



heimatec.u-tec®

heimatec.com

Products / Tool change systems /
u-tec® Tool-changing system



versions see catalog



heimatec.easy-quick

heimatec.com

Products / Tool change systems /
easy-quick HT quick-changing system



versions see catalog



heimatec.Capto™

heimatec.com

Products / Tool change systems /
heimatec.Capto™ quick-changing system



versions see catalog

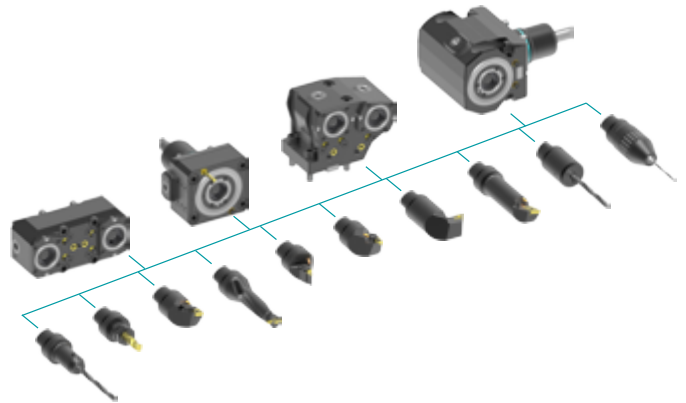

heimatec.accessories

heimatec.com

Products / Accessories



versions see catalog





● heimatec overseas branches

○ global representations of heimatec

heimatec[®]

heimatec GmbH
Präzisionswerkzeuge
Carl-Benz-Str. 4
77871 Renchen
Germany

T +49 7843 9466 0
www.heimatec.com
info@heimatec.com

Please find the contact details of our worldwide trading partners on our website:
<https://heimatec.com/business-partners>