

Miyano

# BNA 42 MSY/2



# High-tech from heimatec - heimatec - Tools and systems for productive turning and milling

heimatec belongs to the international technology and quality leaders for precision tools and specializes in the development and production of high-precision static and live tools for all CNC lathes, CNC turn-/mill machines and CNC machining centers.

The range of products\* spans from static BMT and VDI tool holders, live tools up to highly complex customer-specific individual solutions. heimatec, headquartered in Renchen, has a own subsidiary in Asia and India and numerous representatives as well as trading partners all over the world.

## \*OUR PRODCUTS

Static tool holders

Live tool units

Precision tools

Tools for turning and machining centres

Tools for swiss type lathes

Tool changing and uick-change systems

Tool systems for gear production

Digital tool management



This catalogue, including all its parts, is protected by copyright. Any use outside the restricted limitations of the Copyright Act without the consent of heimatec is inadmissible and liable to prosecution. This applies in particular to duplication, translation, microfilming and storage and processing in electronic systems.



**heimatec GmbH** reserves the right to make technical changes at any time without giving prior notice. This applies in particular to adjustments at any time to meet new or changed international standards, or in case of further developments of our products or manufacturing processes.

The current version of our General Terms and Conditions can be found on our website.

Part-#	Name	
<b>8 010 34 017</b>	<b>Axial drilling and milling head ER 16 AX UT</b>	
	Weight [kg]:	1.450
	Tool drive:	Flat (~DIN 1809)
	Shank size [mm]:	38.00
	Shank type:	BMT
	Tool adaption:	ER 16 A - u-tec
	Gear ratio [i]:	1:1
	Torque max [Nm]:	20
	Rotation max [1/min]:	6000
	Rotating direction:	same
	Coolant:	EXT
<b>8 010 34 018</b>	<b>Axial drilling and milling head ER 16 AX UT IC</b>	
	Weight [kg]:	1.440
	Tool drive:	Flat (~DIN 1809)
	Shank size [mm]:	38.00
	Shank type:	BMT
	Tool adaption:	ER 16 A - u-tec
	Gear ratio [i]:	1:1
	Torque max [Nm]:	20
	Rotation max [1/min]:	6000
	Rotating direction:	same
	Coolant:	IC/Ext
	Pressure max [bar]:	25
<b>8 010 34 022</b>	<b>Axial drilling and milling head ER 20 AX UT</b>	
	Weight [kg]:	1.310
	Version:	Special
	Tool drive:	Flat (~DIN 1809)
	Shank size [mm]:	38.00
	Shank type:	BMT
	Tool adaption:	ER 20 A - u-tec
	Gear ratio [i]:	1:1
	Torque max [Nm]:	20
	Rotation max [1/min]:	6000
	Rotating direction:	same
	Coolant:	EXT
<b>8 010 34 023</b>	<b>Axial drilling and milling head ER 16 AX UT IC</b>	
	Tool drive:	Flat (~DIN 1809)
	Shank size [mm]:	38.00
	Shank type:	BMT
	Tool adaption:	ER 16 A - u-tec
	Gear ratio [i]:	1:1
	Torque max [Nm]:	20
	Rotation max [1/min]:	12000
	Rotating direction:	same
	Coolant:	IC/Ext
	Pressure max [bar]:	100
	Please note:	Dryrun possible

Part-#	Name	
<b>8 010 34 025</b>	<b>Axial drilling and milling head ER 20 AX UT IC</b>	
	Weight [kg]:	1.480
	Version:	Special
	Tool drive:	Flat (~DIN 1809)
	Shank size [mm]:	38.00
	Shank type:	BMT
	Tool adaption:	ER 20 A - u-tec
	Gear ratio [i]:	1:1
	Torque max [Nm]:	20
	Rotation max [1/min]:	12000
	Rotating direction:	same
	Coolant:	IC/Ext
	Pressure max [bar]:	100
	Please note:	Dryrun possible
<b>8 010 34 026</b>	<b>Axial drilling and milling head ER 20 AX UT IC</b>	
	Weight [kg]:	1.500
	Version:	Special
	Tool drive:	Flat (~DIN 1809)
	Shank size [mm]:	38.00
	Shank type:	BMT
	Tool adaption:	ER 20 A - u-tec
	Gear ratio [i]:	1:1
	Torque max [Nm]:	20
	Rotation max [1/min]:	6000
	Rotating direction:	same
	Coolant:	IC/Ext
	Pressure max [bar]:	25
<b>8 010 35 020</b>	<b>Axial drilling and milling head C 3</b>	
	Weight [kg]:	3.280
	Notation:	180° reversible
	Tool drive:	Flat (~DIN 1809)
	Shank size [mm]:	38.00
	Shank type:	BMT
	Tool adaption:	heimatec Capto(TM) C 3
	Gear ratio [i]:	1:1
	Torque max [Nm]:	32
	Rotation max [1/min]:	8000
	Rotating direction:	same
	Coolant:	EXT
	Please note:	Check applicability; tool length check !
<b>8 013 34 007</b>	<b>Axial drilling and milling head ER 16 AX UT</b>	
	Weight [kg]:	1.780
	Tool drive:	Flat (~DIN 1809)
	Shank size [mm]:	38.00
	Shank type:	BMT
	Tool adaption:	ER 16 A - u-tec
	Gear ratio [i]:	1:4
	Torque max [Nm]:	5
	Rotation max [1/min]:	24000
	Rotating direction:	same
	Coolant:	EXT

Part-#	Name	
<b>8 013 34 008</b>	<b>Axial drilling and milling head ER 16 AX UT IC</b>	
	Tool drive:	Flat (~DIN 1809)
	Shank size [mm]:	38.00
	Shank type:	BMT
	Tool adaption:	ER 16 A - u-tec
	Gear ratio [i]:	1:4
	Torque max [Nm]:	5
	Rotation max [1/min]:	24000
	Rotating direction:	same
	Coolant:	IC/Ext
	Pressure max [bar]:	100
	Please note:	Check applicability; note tool length!
<b>8 019 34 004</b>	<b>Axial drilling and milling head ER 16 AX UT</b>	
	Weight [kg]:	2.500
	Notation:	180° reversible
	Tool drive:	Flat (~DIN 1809)
	Shank size [mm]:	38.00
	Shank type:	BMT
	Tool adaption:	ER 16 A - u-tec
	Gear ratio [i]:	1:2
	Torque max [Nm]:	6
	Rotation max [1/min]:	12000
	Rotating direction:	opposite
	Coolant:	EXT
	Offset [mm]:	34,5
<b>8 019 34 005</b>	<b>Axial drilling and milling head ER 16 AX UT IC</b>	
	Weight [kg]:	3.100
	Notation:	180° reversible
	Tool drive:	Flat (~DIN 1809)
	Shank size [mm]:	38.00
	Shank type:	BMT
	Tool adaption:	ER 16 A - u-tec
	Gear ratio [i]:	1:2
	Torque max [Nm]:	6
	Rotation max [1/min]:	12000
	Rotating direction:	opposite
	Coolant:	IC/Ext
	Pressure max [bar]:	140
	Offset [mm]:	34,5
<b>8 019 34 006</b>	<b>Axial drilling and milling head ER 16 AX UT</b>	
	Weight [kg]:	2.510
	Notation:	180° reversible
	Tool drive:	Flat (~DIN 1809)
	Shank size [mm]:	38.00
	Shank type:	BMT
	Tool adaption:	ER 16 A - u-tec
	Gear ratio [i]:	2:1
	Torque max [Nm]:	20
	Rotation max [1/min]:	3000
	Rotating direction:	opposite
	Coolant:	EXT

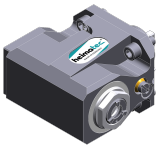
Part-#	Name	
<b>8 019 34 007</b>	<b>Axial drilling and milling head ER 16 AX UT IC</b>	
	Weight [kg]:	3.260
	Notation:	180° reversible
	Tool drive:	Flat (~DIN 1809)
	Shank size [mm]:	38.00
	Shank type:	BMT
	Tool adaption:	ER 16 A - u-tec
	Gear ratio [i]:	2:1
	Torque max [Nm]:	20
	Rotation max [1/min]:	3000
	Rotating direction:	opposite
	Coolant:	IC/Ext
	Pressure max [bar]:	140
	Offset [mm]:	29
<b>8 019 35 012</b>	<b>Axial drilling and milling head C 3 IC</b>	
	Weight [kg]:	5.990
	Tool drive:	Flat (~DIN 1809)
	Shank size [mm]:	38.00
	Shank type:	BMT
	Tool adaption:	heimatec Capto(TM) C 3
	Gear ratio [i]:	1:1
	Torque max [Nm]:	32
	Rotation max [1/min]:	8000
	Rotating direction:	same
	Coolant:	IC/Ext
	Pressure max [bar]:	140
	Please note:	Check applicability; note tool length!
	Offset [mm]:	71
<b>8 030 34 016</b>	<b>Angle-mill- and drill holder ER 16 AX UT</b>	
	Weight [kg]:	3.320
	Notation:	180° reversible
	Tool drive:	Flat (~DIN 1809)
	Shank size [mm]:	38.00
	Shank type:	BMT
	Tool adaption:	ER 16 A - u-tec
	Gear ratio [i]:	1:1
	Torque max [Nm]:	20
	Rotation max [1/min]:	8000
	Rotating direction:	opposite
	Coolant:	EXT
	Please note:	Combi bearing
	Center distance [mm]:	59
<b>8 030 34 017</b>	<b>Angle-mill- and drill holder ER 16 AX UT IC</b>	
	Weight [kg]:	3.560
	Notation:	180° reversible
	Tool drive:	Flat (~DIN 1809)
	Shank size [mm]:	38.00
	Shank type:	BMT
	Tool adaption:	ER 16 A - u-tec
	Gear ratio [i]:	1:1
	Torque max [Nm]:	20
	Rotation max [1/min]:	8000
	Rotating direction:	opposite
	Coolant:	IC/Ext

Part-#	Name
--------	------

Pressure max [bar]: 140  
Please note: Combi bearing  
Center distance [mm]: 59

**8 030 34 018 Radial drilling and milling head ER 16 AX UT**

Weight [kg]: 3.920  
Notation: 180° reversible  
Tool drive: Flat (~DIN 1809)  
Shank size [mm]: 38.00  
Shank type: BMT  
Tool adaption: ER 16 A - u-tec  
Gear ratio [i]: 1:2  
Torque max [Nm]: 6  
Rotation max [1/min]: 12000  
Rotating direction: same  
Coolant: EXT  
Center distance [mm]: 73,5

**8 030 34 019 Radial drilling and milling head ER 16 AX UT IC**



Weight [kg]: 3.980  
Notation: 180° reversible  
Tool drive: Flat (~DIN 1809)  
Shank size [mm]: 38.00  
Shank type: BMT  
Tool adaption: ER 16 A - u-tec  
Gear ratio [i]: 1:2  
Torque max [Nm]: 6  
Rotation max [1/min]: 12000  
Rotating direction: same  
Coolant: IC/Ext  
Pressure max [bar]: 140  
Center distance [mm]: 73,5

**8 030 34 026 Angle-mill- and drill holder ER 20 AX UT**



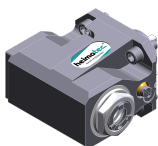

Weight [kg]: 3.300  
Notation: 180° reversible  
Tool drive: Flat (~DIN 1809)  
Shank size [mm]: 38.00  
Shank type: BMT  
Tool adaption: ER 20 A - u-tec  
Gear ratio [i]: 1:1  
Torque max [Nm]: 20  
Rotation max [1/min]: 8000  
Rotating direction: opposite  
Coolant: EXT  
Please note: Combi bearing  
Center distance [mm]: 59

**8 030 34 028 Angle-mill- and drill holder ER 20 AX UT IC**

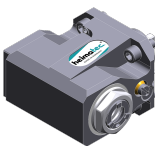

Weight [kg]: 3.550  
Notation: 180° reversible  
Tool drive: Flat (~DIN 1809)  
Shank size [mm]: 38.00  
Shank type: BMT  
Tool adaption: ER 20 A - u-tec  
Gear ratio [i]: 1:1  
Torque max [Nm]: 20

Part-#	Name	
	Rotation max [1/min]:	8000
	Rotating direction:	opposite
	Coolant:	IC/Ext
	Pressure max [bar]:	140
	Please note:	Combi bearing
	Center distance [mm]:	59
<b>8 030 34 029</b>	<b>Radial drilling and milling head ER 16 AX UT</b>	
	Notation:	180° reversible
	Tool drive:	Flat (~DIN 1809)
	Shank size [mm]:	38.00
	Shank type:	BMT
	Tool adaption:	ER 16 A - u-tec
	Gear ratio [i]:	1:4
	Torque max [Nm]:	5
	Rotation max [1/min]:	24000
	Rotating direction:	opposite
	Coolant:	EXT
	Center distance [mm]:	59
<b>8 030 34 036</b>	<b>Radial drilling and milling head ER 16 AX UT</b>	
	Weight [kg]:	3.970
	Notation:	180° reversible
	Tool drive:	Flat (~DIN 1809)
	Shank size [mm]:	38.00
	Shank type:	BMT
	Tool adaption:	ER 16 A - u-tec
	Gear ratio [i]:	1:3
	Torque max [Nm]:	6
	Rotation max [1/min]:	18000
	Rotating direction:	same
	Coolant:	EXT
	Center distance [mm]:	73,5
<b>8 030 34 037</b>	<b>Radial drilling and milling head ER 16 AX UT IC</b>	
	Weight [kg]:	3.900
	Notation:	180° reversible
	Tool drive:	Flat (~DIN 1809)
	Shank size [mm]:	38.00
	Shank type:	BMT
	Tool adaption:	ER 16 A - u-tec
	Gear ratio [i]:	1:4
	Torque max [Nm]:	5
	Rotation max [1/min]:	24000
	Rotating direction:	opposite
	Coolant:	IC/Ext
	Pressure max [bar]:	140
	Center distance [mm]:	59
<b>8 030 34 045</b>	<b>Radial drilling and milling head ER 20 AX UT IC</b>	
	Weight [kg]:	3.520
	Notation:	180° reversible
	Tool drive:	Flat (~DIN 1809)
	Shank size [mm]:	38.00
	Shank type:	BMT
	Tool adaption:	ER 20 A - u-tec

Part-#	Name
--------	------

Gear ratio [i]: 1:1  
 Torque max [Nm]: 20  
 Rotation max [1/min]: 12000  
 Rotating direction: opposite  
 Coolant: IC/Ext  
 Pressure max [bar]: 140  
 Center distance [mm]: 59

**8 030 34 046 Radial drilling and milling head ER 20 AX UT**

Weight [kg]: 3.270  
 Notation: 180° reversible  
 Tool drive: Flat (~DIN 1809)  
 Shank size [mm]: 38.00  
 Shank type: BMT  
 Tool adaption: ER 20 A - u-tec  
 Gear ratio [i]: 1:1  
 Torque max [Nm]: 20  
 Rotation max [1/min]: 12000  
 Rotating direction: opposite  
 Coolant: EXT  
 Center distance [mm]: 59

**8 030 34 048 Radial drilling and milling head ER 16 AX UT IC**

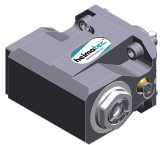

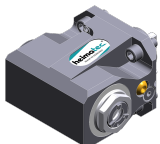

Weight [kg]: 3.540  
 Notation: 180° reversible  
 Tool drive: Flat (~DIN 1809)  
 Shank size [mm]: 38.00  
 Shank type: BMT  
 Tool adaption: ER 16 A - u-tec  
 Gear ratio [i]: 1:1  
 Torque max [Nm]: 20  
 Rotation max [1/min]: 12000  
 Rotating direction: opposite  
 Coolant: IC/Ext  
 Pressure max [bar]: 140  
 Center distance [mm]: 59

**8 030 34 049 Radial drilling and milling head ER 16 AX UT**



Weight [kg]: 3.280  
 Notation: 180° reversible  
 Tool drive: Flat (~DIN 1809)  
 Shank size [mm]: 38.00  
 Shank type: BMT  
 Tool adaption: ER 16 A - u-tec  
 Gear ratio [i]: 1:1  
 Torque max [Nm]: 20  
 Rotation max [1/min]: 12000  
 Rotating direction: opposite  
 Coolant: EXT  
 Center distance [mm]: 59

Part-#	Name	
<b>8 030 35 031</b>	<b>Radial drilling and milling head C 3 IC</b>	
	Weight [kg]:	6.790
	Notation:	180° reversible
	Tool drive:	Flat (~DIN 1809)
	Shank size [mm]:	38.00
	Shank type:	BMT
	Tool adaption:	heimatec Capto(TM) C 3
	Gear ratio [i]:	1:1
	Torque max [Nm]:	25
	Rotation max [1/min]:	8000
	Rotating direction:	opposite
	Coolant:	IC/Ext
	Pressure max [bar]:	140
	Please note:	Check applicability; note tool length!
	Center distance [mm]:	65
<b>8 030 35 032</b>	<b>Radial drilling and milling head C 3 IC</b>	
	Weight [kg]:	6.180
	Notation:	180° reversible
	Tool drive:	Flat (~DIN 1809)
	Shank size [mm]:	38.00
	Shank type:	BMT
	Tool adaption:	heimatec Capto(TM) C 3
	Gear ratio [i]:	1:1
	Torque max [Nm]:	25
	Rotation max [1/min]:	8000
	Rotating direction:	opposite
	Coolant:	IC/Ext
	Pressure max [bar]:	140
	Please note:	Check applicability; note tool length!
	Center distance [mm]:	65
<b>8 031 34 003</b>	<b>Radial polygon head arbor 16</b>	
	Weight [kg]:	3.420
	Notation:	180° reversible
	Tool drive:	Flat (~DIN 1809)
	Shank size [mm]:	38.00
	Shank type:	BMT
	Tool adaption:	Polygon arbor 16
	Gear ratio [i]:	1:1
	Torque max [Nm]:	20
	Rotation max [1/min]:	6000
	Rotating direction:	opposite
	Coolant:	EXT
	Please note:	Combi bearing
	Center distance [mm]:	59
<b>8 033 34 003</b>	<b>Radial drilling and milling head ER 16 AX UT</b>	
	Weight [kg]:	3.960
	Notation:	offset
	Employment for:	Sub spindle
	Tool drive:	Flat (~DIN 1809)
	Shank size [mm]:	38.00
	Shank type:	BMT
	Tool adaption:	ER 16 A - u-tec
	Gear ratio [i]:	1:1
	Torque max [Nm]:	20

Part-#

Name

Rotation max [1/min]: 6000  
 Rotating direction: same  
 Coolant: EXT  
 Please note: Combi bearing  
 Center distance [mm]: 59

**8 033 34 004 Radial drilling and milling head ER 16 AX UT IC**

Weight [kg]: 4.360  
 Notation: offset  
 Employment for: Sub spindle  
 Tool drive: Flat (~DIN 1809)  
 Shank size [mm]: 38.00  
 Shank type: BMT  
 Tool adaption: ER 16 A - u-tec  
 Gear ratio [i]: 1:1  
 Torque max [Nm]: 20  
 Rotation max [1/min]: 6000  
 Rotating direction: same  
 Coolant: IC/Ext  
 Pressure max [bar]: 140  
 Please note: Combi bearing  
 Center distance [mm]: 59



**8 033 34 007 Radial drilling and milling head ER 20 AX UT**

Weight [kg]: 4.070  
 Notation: offset  
 Employment for: Sub spindle  
 Tool drive: Flat (~DIN 1809)  
 Shank size [mm]: 38.00  
 Shank type: BMT  
 Tool adaption: ER 20 A - u-tec  
 Gear ratio [i]: 1:1  
 Torque max [Nm]: 20  
 Rotation max [1/min]: 6000  
 Rotating direction: same  
 Coolant: EXT  
 Please note: Combi bearing  
 Center distance [mm]: 59

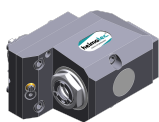
**8 033 34 008 Radial drilling and milling head ER 20 AX UT IC**



Weight [kg]: 4.240  
 Notation: offset  
 Employment for: Sub spindle  
 Tool drive: Flat (~DIN 1809)  
 Shank size [mm]: 38.00  
 Shank type: BMT  
 Tool adaption: ER 20 A - u-tec  
 Gear ratio [i]: 1:1  
 Torque max [Nm]: 20  
 Rotation max [1/min]: 6000  
 Rotating direction: same  
 Coolant: IC/Ext  
 Pressure max [bar]: 140  
 Please note: Combi bearing  
 Center distance [mm]: 59

Part-#	Name	
<b>8 033 34 009</b>	<b>Radial drilling and milling head ER 16 AX UT IC</b>	
	Weight [kg]:	4.340
	Notation:	offset
	Employment for:	Sub spindle
	Tool drive:	Flat (~DIN 1809)
	Shank size [mm]:	38.00
	Shank type:	BMT
	Tool adaption:	ER 16 A - u-tec
	Gear ratio [i]:	1:2
	Torque max [Nm]:	12
	Rotation max [1/min]:	12000
	Rotating direction:	same
	Coolant:	IC/Ext
	Pressure max [bar]:	140
	Center distance [mm]:	59
<b>8 033 34 010</b>	<b>Radial drilling and milling head ER 16 AX UT</b>	
	Notation:	offset
	Tool drive:	Flat (~DIN 1809)
	Shank size [mm]:	38.00
	Shank type:	BMT
	Tool adaption:	ER 16 A - u-tec
	Gear ratio [i]:	1:2
	Torque max [Nm]:	12
	Rotation max [1/min]:	12000
	Rotating direction:	same
	Coolant:	EXT
	Center distance [mm]:	59
<b>8 037 31 000</b>	<b>Radial disk mill head arbor 8</b>	
	Weight [kg]:	3.720
	Notation:	180° reversible
	Tool drive:	Flat (~DIN 1809)
	Shank size [mm]:	38.00
	Shank type:	BMT
	Tool adaption:	Arbor 8
	Gear ratio [i]:	2:1
	Torque max [Nm]:	20
	Rotation max [1/min]:	3000
	Rotating direction:	opposite
	Coolant:	EXT
	Please note:	Check applicability!
	Center distance [mm]:	65
<b>8 037 33 002</b>	<b>Radial disk mill head arbor 13</b>	
	Weight [kg]:	3.780
	Notation:	180° reversible
	Version:	0° position can be pinned
	Tool drive:	Flat (~DIN 1809)
	Shank size [mm]:	38.00
	Shank type:	BMT
	Tool adaption:	Arbor 13
	Gear ratio [i]:	2:1
	Torque max [Nm]:	20
	Rotation max [1/min]:	3000
	Rotating direction:	opposite
	Coolant:	EXT

Part-#	Name
--------	------

Please note: Check applicability!  
Center distance [mm]: 65

8 037 34 003



**Woodruff keycutter ER 16 AX UT**  
Weight [kg]: 3.300  
Notation: 180° reversible  
Tool drive: Flat (~DIN 1809)  
Shank size [mm]: 38.00  
Shank type: BMT  
Tool adaption: ER 16 A - u-tec  
Gear ratio [i]: 2:1  
Torque max [Nm]: 20  
Rotation max [1/min]: 3000  
Rotating direction: opposite  
Coolant: EXT  
Center distance [mm]: 65

8 037 34 007



**Radial disk mill head arbor 16**  
Weight [kg]: 3.880  
Notation: 180° reversible  
Version: 0° position can be pinned  
Tool drive: Flat (~DIN 1809)  
Shank size [mm]: 38.00  
Shank type: BMT  
Tool adaption: Arbor 16  
Gear ratio [i]: 2:1  
Torque max [Nm]: 20  
Rotation max [1/min]: 3000  
Rotating direction: opposite  
Coolant: EXT  
Please note: Check applicability!  
Center distance [mm]: 65

8 039 34 006



**Radial drilling and milling head ER 16 AX UT**  
Weight [kg]: 2.800  
Notation: 180° reversible  
Version: double spindle  
Tool drive: Flat (~DIN 1809)  
Shank size [mm]: 38.00  
Shank type: BMT  
Tool adaption: ER 16 u-tec  
Gear ratio [i]: 1:1  
Torque max [Nm]: 20  
Rotation max [1/min]: 12000  
Rotating direction: same/opposite  
Coolant: EXT  
Please note: stronger bearing  
Center distance [mm]: 59

8 039 34 007



**Radial drilling and milling head ER 16 AX UT**  
Weight [kg]: 4.370  
Notation: offset  
Employment for: Main- and sub spindle  
Version: double spindle  
Tool drive: Flat (~DIN 1809)  
Shank size [mm]: 38.00

Part-#	Name
--------	------

Shank type: BMT  
 Tool adaption: ER 16 A - u-tec  
 Gear ratio [i]: 1:1  
 Torque max [Nm]: 20  
 Rotation max [1/min]: 6000  
 Rotating direction: same/opposite  
 Coolant: EXT  
 Please note: stronger bearing  
 Center distance [mm]: 59

**8 039 34 012 Radial drilling and milling head ER 20 AX UT**



Notation: 180° reversible  
 Version: double spindle  
 Tool drive: Flat (~DIN 1809)  
 Shank size [mm]: 38.00  
 Shank type: BMT  
 Tool adaption: ER 20 A - u-tec  
 Gear ratio [i]: 1:1  
 Torque max [Nm]: 20  
 Rotation max [1/min]: 12000  
 Rotating direction: same/opposite  
 Coolant: EXT  
 Please note: stronger bearing  
 Center distance [mm]: 59

**8 039 34 013 Radial drilling and milling head ER 20 AX UT**

Weight [kg]: 4.260  
 Notation: offset  
 Employment for: Main- and sub spindle  
 Version: double spindle  
 Tool drive: Flat (~DIN 1809)  
 Shank size [mm]: 38.00  
 Shank type: BMT  
 Tool adaption: ER 20 A - u-tec  
 Gear ratio [i]: 1:1  
 Torque max [Nm]: 20  
 Rotation max [1/min]: 6000  
 Rotating direction: same/opposite  
 Coolant: EXT  
 Please note: stronger bearing  
 Center distance [mm]: 59

**8 039 34 014 Radial drilling and milling head ER 16 AX UT**

Weight [kg]: 4.270  
 Employment for: Main- and sub spindle  
 Version: double spindle  
 Tool drive: Flat (~DIN 1809)  
 Shank size [mm]: 38.00  
 Shank type: BMT  
 Tool adaption: ER 16 A - u-tec  
 Gear ratio [i]: 1:1  
 Torque max [Nm]: 20/Sp.  
 Rotation max [1/min]: 6000  
 Rotating direction: same  
 Coolant: EXT  
 Please note: stronger bearing  
 Center distance [mm]: 45/80

Part-#	Name	
<b>8 039 34 015</b>	<b>Radial drilling and milling head ER 16 AX UT IC</b>	
	Weight [kg]:	4.620
	Employment for:	Main- and sub spindle
	Version:	double spindle
	Tool drive:	Flat (~DIN 1809)
	Shank size [mm]:	38.00
	Shank type:	BMT
	Tool adaption:	ER 16 A - u-tec
	Gear ratio [i]:	1:1
	Torque max [Nm]:	20/Sp.
	Rotation max [1/min]:	6000
	Rotating direction:	same
	Coolant:	IC/Ext
	Pressure max [bar]:	140
	Please note:	stronger bearing
	Center distance [mm]:	45/80
<b>8 039 34 018</b>	<b>Radial drilling and milling head ER 16 AX UT</b>	
	Weight [kg]:	4.370
	Notation:	offset
	Employment for:	Main- and sub spindle
	Version:	double spindle
	Tool drive:	Flat (~DIN 1809)
	Shank size [mm]:	38.00
	Shank type:	BMT
	Tool adaption:	ER 16 A - u-tec
	Gear ratio [i]:	1:2
	Torque max [Nm]:	12
	Rotation max [1/min]:	12000
	Rotating direction:	same
	Coolant:	EXT
	Please note:	stronger bearing
	Center distance [mm]:	59
<b>8 039 35 008</b>	<b>Radial drilling and milling head C 3</b>	
	Weight [kg]:	7.675
	Notation:	180° reversible
	Employment for:	Main- and sub spindle
	Version:	double spindle
	Tool drive:	Flat (~DIN 1809)
	Shank size [mm]:	38.00
	Shank type:	BMT
	Tool adaption:	heimatec Capto(TM) C 3
	Gear ratio [i]:	1:1
	Torque max [Nm]:	25
	Rotation max [1/min]:	8000
	Rotating direction:	same/opposite
	Coolant:	EXT
	Please note:	Check applicability; note tool length!
	Center distance [mm]:	65

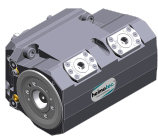

Part-#	Name
--------	------

8 043 34 002



**Universal head +105°/-20° adj. ER16 AX UT**

Notation: offset  
 Employment for: Main spindle  
 Tool drive: Flat (~DIN 1809)  
 Shank size [mm]: 38.00  
 Shank type: BMT  
 Tool adaption: ER 16 A - u-tec  
 Gear ratio [i]: 1:1  
 Torque max [Nm]: 20  
 Rotation max [1/min]: 6000  
 Rotating direction: opposite  
 Coolant: EXT  
 Pressure max [bar]: 140  
 Center distance [mm]: 50  
 Offset [mm]: 35

8 043 34 003



**Universal head +105°/-20° adj. ER16AX UTIK**

Notation: offset  
 Employment for: Main spindle  
 Tool drive: Flat (~DIN 1809)  
 Shank size [mm]: 38.00  
 Shank type: BMT  
 Tool adaption: ER 16 A - u-tec  
 Gear ratio [i]: 1:1  
 Torque max [Nm]: 20  
 Rotation max [1/min]: 6000  
 Rotating direction: opposite  
 Coolant: IC/Ext  
 Pressure max [bar]: 25  
 Center distance [mm]: 50  
 Offset [mm]: 35

8 043 34 004



**Universal head +105°/-20° adj. ER16 AX UT**

Notation: offset  
 Employment for: Main spindle  
 Tool drive: Flat (~DIN 1809)  
 Shank size [mm]: 38.00  
 Shank type: BMT  
 Tool adaption: ER 16 A - u-tec  
 Gear ratio [i]: 1:2  
 Torque max [Nm]: 6  
 Rotation max [1/min]: 12000  
 Rotating direction: opposite  
 Coolant: EXT  
 Center distance [mm]: 50  
 Offset [mm]: 35

8 043 34 005

**Universal head +105°/-20° adj. ER16AX UTIK**

Notation: offset  
 Employment for: Main spindle  
 Tool drive: Flat (~DIN 1809)  
 Shank size [mm]: 38.00  
 Shank type: BMT  
 Tool adaption: ER 16 A - u-tec  
 Gear ratio [i]: 1:2  
 Torque max [Nm]: 6  
 Rotation max [1/min]: 12000

Part-#	Name
--------	------

Rotating direction:	opposite
Coolant:	IC/Ext
Pressure max [bar]:	25
Center distance [mm]:	50
Offset [mm]:	35

**8 043 34 006 Universal head +120°/-40° adj. ER16 AX UT**

Weight [kg]:	4.790
Notation:	offset
Employment for:	Main spindle
Version:	Special
Tool drive:	Flat (~DIN 1809)
Shank size [mm]:	38.00
Shank type:	BMT
Tool adaption:	ER 16 A - u-tec
Gear ratio [i]:	1:1
Torque max [Nm]:	20
Rotation max [1/min]:	6000
Rotating direction:	opposite
Coolant:	EXT
Center distance [mm]:	50
Offset [mm]:	35

**8 043 34 012 Universal head +110°/-90° adj. ER16 AX UT**





Notation:	offset; 180° reversible
Employment for:	Main- and sub spindle
Version:	Special
Tool drive:	Flat (~DIN 1809)
Shank size [mm]:	38.00
Shank type:	BMT
Tool adaption:	ER 16 A - u-tec
Gear ratio [i]:	1:2
Torque max [Nm]:	6
Rotation max [1/min]:	12000
Rotating direction:	opposite
Coolant:	EXT
Pressure max [bar]:	140
Please note:	Note swivel range!
Center distance [mm]:	66
Offset [mm]:	15

**8 043 34 019 Universal head - 30°/-90° adj. ER16AX UTIK**



Notation:	offset; 180° reversible
Employment for:	Main- and sub spindle
Version:	Special
Tool drive:	Flat (~DIN 1809)
Shank size [mm]:	38.00
Shank type:	BMT
Tool adaption:	ER 16 A - u-tec
Gear ratio [i]:	1:2
Torque max [Nm]:	6
Rotation max [1/min]:	12000
Rotating direction:	opposite
Coolant:	IC/Ext
Pressure max [bar]:	140
Please note:	Note swivel range!
Center distance [mm]:	66

Part-#	Name	
	Offset [mm]:	15
<b>8 050 34 000</b>	<b>Multispindle drilling head ER 16 AX UT</b>	
	Weight [kg]:	3.400
	Version:	2-spindles
	Tool drive:	Flat (~DIN 1809)
	Shank size [mm]:	38.00
	Shank type:	BMT
	Tool adaption:	ER 16 A - u-tec
	Gear ratio [i]:	1:1
	Torque max [Nm]:	16/Sp.
	Rotation max [1/min]:	6000
	Rotating direction:	same
	Coolant:	EXT
	Offset [mm]:	60
<b>8 050 34 001</b>	<b>Multispindle drilling head ER 16 AX UT IC</b>	
	Weight [kg]:	3.580
	Version:	2-spindles
	Tool drive:	Flat (~DIN 1809)
	Shank size [mm]:	38.00
	Shank type:	BMT
	Tool adaption:	ER 16 A - u-tec
	Gear ratio [i]:	1:1
	Torque max [Nm]:	16/Sp.
	Rotation max [1/min]:	6000
	Rotating direction:	same
	Coolant:	IC/Ext
	Pressure max [bar]:	140
	Offset [mm]:	60
<b>8 050 34 002</b>	<b>Multispindle drilling head ER 16 AX UT</b>	
	Weight [kg]:	3.250
	Notation:	180° reversible
	Version:	2-spindles
	Tool drive:	Flat (~DIN 1809)
	Shank size [mm]:	38.00
	Shank type:	BMT
	Tool adaption:	ER 16 A - u-tec
	Gear ratio [i]:	1:1
	Torque max [Nm]:	20/Sp.
	Rotation max [1/min]:	6000
	Rotating direction:	opposite
	Coolant:	EXT
	Offset [mm]:	±34,5
<b>8 050 34 003</b>	<b>Multispindle drilling head ER 16 AX UT IC</b>	
	Weight [kg]:	4.130
	Notation:	180° reversible
	Version:	2-spindles
	Tool drive:	Flat (~DIN 1809)
	Shank size [mm]:	38.00
	Shank type:	BMT
	Tool adaption:	ER 16 A - u-tec
	Gear ratio [i]:	1:1
	Torque max [Nm]:	20/Sp.
	Rotation max [1/min]:	6000

Part-#	Name	
	Rotating direction:	opposite
	Coolant:	IC/Ext
	Pressure max [bar]:	140
	Offset [mm]:	+34,5/-34,5
<b>8 050 34 004</b>	<b>Multispindle drilling head ER 16 AX UT</b>	
	Weight [kg]:	3.410
	Version:	3-spindles
	Tool drive:	Flat (~DIN 1809)
	Shank size [mm]:	38.00
	Shank type:	BMT
	Tool adaption:	ER 16 A - u-tec
	Gear ratio [i]:	1:1
	Torque max [Nm]:	16/Sp.
	Rotation max [1/min]:	6000
	Rotating direction:	same
	Coolant:	EXT
	Please note:	2xER 16A UT offset, 1x centre of shank
<b>8 050 34 005</b>	<b>Multispindle drilling head ER 16 AX UT</b>	
	Weight [kg]:	3.160
	Notation:	180° reversible
	Version:	2-spindles
	Tool drive:	Flat (~DIN 1809)
	Shank size [mm]:	38.00
	Shank type:	BMT
	Tool adaption:	ER 16 A - u-tec
	Gear ratio [i]:	1:2
	Torque max [Nm]:	6/Sp.
	Rotation max [1/min]:	12000
	Rotating direction:	opposite
	Coolant:	EXT
	Offset [mm]:	+34,5/-34,5
<b>8 050 34 007</b>	<b>Multispindle drilling head ER 16 AX UT IC</b>	
	Weight [kg]:	3.590
	Version:	3-spindles
	Tool drive:	Flat (~DIN 1809)
	Shank size [mm]:	38.00
	Shank type:	BMT
	Tool adaption:	ER 16 A - u-tec
	Gear ratio [i]:	1:1
	Torque max [Nm]:	16/Sp.
	Rotation max [1/min]:	6000
	Rotating direction:	same
	Coolant:	IC/Ext
	Pressure max [bar]:	140
	Please note:	2x ER16A UT offset; 1x centre of shank
	Offset [mm]:	60
<b>8 050 34 009</b>	<b>Multispindle drilling head ER 16 AX UT IC</b>	
	Weight [kg]:	3.610
	Version:	2-spindles
	Tool drive:	Flat (~DIN 1809)
	Shank size [mm]:	38.00
	Shank type:	BMT
	Tool adaption:	ER 16 A - u-tec

Part-#	Name	
	Gear ratio [i]:	1:2
	Torque max [Nm]:	8/Sp.
	Rotation max [1/min]:	12000
	Rotating direction:	same
	Coolant:	IC/Ext
	Pressure max [bar]:	140
	Offset [mm]:	60
<b>8 050 34 011</b>	<b>Multispindle drilling head ER 16 AX UT IC</b>	
	Weight [kg]:	3.600
	Version:	2-spindles
	Tool drive:	Flat (~DIN 1809)
	Shank size [mm]:	38.00
	Shank type:	BMT
	Tool adaption:	ER 16 A - u-tec
	Gear ratio [i]:	1:1
	Torque max [Nm]:	16/Sp.
	Rotation max [1/min]:	6000
	Rotating direction:	same
	Coolant:	IC air
	Pressure max [bar]:	10
	Offset [mm]:	60
<b>8 053 34 000</b>	<b>Multispindle radial head ER 16 AX UT</b>	
	Weight [kg]:	4.560
	Employment for:	Main spindle
	Version:	2-spindles
	Tool drive:	Flat (~DIN 1809)
	Shank size [mm]:	38.00
	Shank type:	BMT
	Tool adaption:	ER 16 A - u-tec
	Gear ratio [i]:	1:1
	Torque max [Nm]:	20
	Rotation max [1/min]:	6000
	Rotating direction:	same/opposite
	Coolant:	EXT
	Please note:	stronger bearing
	Center distance [mm]:	37/72
<b>8 053 34 001</b>	<b>Multispindle radial head ER 16AX UT IC</b>	
	Weight [kg]:	4.980
	Employment for:	Main spindle
	Version:	2-spindles
	Tool drive:	Flat (~DIN 1809)
	Shank size [mm]:	38.00
	Shank type:	BMT
	Tool adaption:	ER 16 A - u-tec
	Gear ratio [i]:	1:1
	Torque max [Nm]:	20
	Rotation max [1/min]:	6000
	Rotating direction:	same/opposite
	Coolant:	IC/Ext
	Pressure max [bar]:	140
	Please note:	stronger bearing
	Center distance [mm]:	37/72

Part-#	Name
--------	------

8 053 34 002



**Multispindle radial head ER 16 AX UT**

Weight [kg]: 7.110  
 Employment for: Main spindle  
 Version: 4-spindles  
 Tool drive: Flat (~DIN 1809)  
 Shank size [mm]: 38.00  
 Shank type: BMT  
 Tool adaption: ER 16 A - u-tec  
 Gear ratio [i]: 1:1  
 Torque max [Nm]: 16  
 Rotation max [1/min]: 6000  
 Rotating direction: same  
 Coolant: EXT  
 Please note: stronger bearing  
 Center distance [mm]: 45/80

8 053 34 003



**Multispindle radial head ER 16AX UT IC**

Weight [kg]: 7.660  
 Employment for: Main spindle  
 Version: 4-spindles  
 Tool drive: Flat (~DIN 1809)  
 Shank size [mm]: 38.00  
 Shank type: BMT  
 Tool adaption: ER 16 A - u-tec  
 Gear ratio [i]: 1:1  
 Torque max [Nm]: 16  
 Rotation max [1/min]: 6000  
 Rotating direction: same  
 Coolant: IC/Ext  
 Pressure max [bar]: 140  
 Please note: stronger bearing  
 Center distance [mm]: 45/80

8 053 34 004

**Multispindle radial head ER 16 AX UT**

Weight [kg]: 4.910  
 Employment for: Main spindle  
 Version: 2-spindles  
 Tool drive: Flat (~DIN 1809)  
 Shank size [mm]: 38.00  
 Shank type: BMT  
 Tool adaption: ER 16 A - u-tec  
 Gear ratio [i]: 1:1  
 Torque max [Nm]: 20  
 Rotation max [1/min]: 6000  
 Rotating direction: same/opposite  
 Coolant: EXT  
 Please note: stronger bearing  
 Center distance [mm]: 45/80

8 053 34 005

**Multispindle radial head ER 16AX UT IC**

Weight [kg]: 5.510  
 Employment for: Main spindle  
 Version: 2-spindles  
 Tool drive: Flat (~DIN 1809)  
 Shank size [mm]: 38.00  
 Shank type: BMT  
 Tool adaption: ER 16 A - u-tec

Part-#	Name
--------	------

Gear ratio [i]: 1:1  
 Torque max [Nm]: 20  
 Rotation max [1/min]: 6000  
 Rotating direction: same/opposite  
 Coolant: IC/Ext  
 Pressure max [bar]: 140  
 Please note: stronger bearing  
 Center distance [mm]: 45/80

**8 053 34 009 Multispindle radial head ER 16 AX UT**

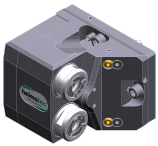

Weight [kg]: 5.520  
 Notation: 180° reversible  
 Employment for: Main- and sub spindle  
 Version: 2-spindles; offset  
 Tool drive: Flat (~DIN 1809)  
 Shank size [mm]: 38.00  
 Shank type: BMT  
 Tool adaption: ER 16 A - u-tec  
 Gear ratio [i]: 1:1  
 Torque max [Nm]: 16  
 Rotation max [1/min]: 6000  
 Rotating direction: same  
 Coolant: EXT  
 Please note: stronger bearing  
 Center distance [mm]: 80

**8 053 34 010 Multispindle radial head ER16 AX UT IC**

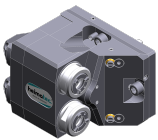

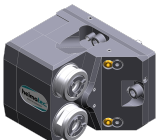

Weight [kg]: 5.740  
 Notation: 180° reversible  
 Employment for: Main- and sub spindle  
 Version: 2-spindles; offset  
 Tool drive: Flat (~DIN 1809)  
 Shank size [mm]: 38.00  
 Shank type: BMT  
 Tool adaption: ER 16 A - u-tec  
 Gear ratio [i]: 1:1  
 Torque max [Nm]: 16  
 Rotation max [1/min]: 6000  
 Rotating direction: same  
 Coolant: IC/Ext  
 Pressure max [bar]: 140  
 Please note: stronger bearing  
 Center distance [mm]: 80

**8 053 34 011 Multispindle radial head ER 16 AX UT**



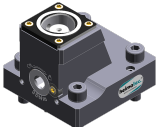

Weight [kg]: 5.540  
 Notation: 180° reversible  
 Employment for: Main- and sub spindle  
 Version: 2-spindles; offset  
 Tool drive: Flat (~DIN 1809)  
 Shank size [mm]: 38.00  
 Shank type: BMT  
 Tool adaption: ER 16 A - u-tec  
 Gear ratio [i]: 1:2  
 Torque max [Nm]: 8  
 Rotation max [1/min]: 12000  
 Rotating direction: same

Part-#	Name	
	Coolant:	EXT
	Please note:	stronger bearing
	Center distance [mm]:	80
<b>8 068 34 000</b>	<b>Radial whirling unit HW 46</b>	
	Weight [kg]:	4.100
	Notation:	180° reversible
	Tool drive:	Flat (~DIN 1809)
	Shank size [mm]:	38.00
	Shank type:	BMT
	Tool adaption:	HW 46
	Gear ratio [i]:	1:1
	Torque max [Nm]:	16
	Rotation max [1/min]:	8000
	Rotating direction:	same
	Coolant:	no
	Center distance [mm]:	65
<b>8 200 02 000</b>	<b>Cover plate</b>	
	Weight [kg]:	0.248
	Shank type:	-
<b>8 202 00 012</b>	<b>Basic holder longitudinal seat FN 12</b>	
	Weight [kg]:	0.860
	Notation:	180° reversible
	Shank type:	BMT
	Machine adaption:	Centering bolt ø 12
	Tool adaption:	Interface FN 12
	Coolant:	EXT
<b>8 224 04 071</b>	<b>Universal turning holder sq. 20 IC</b>	
	Notation:	180° reversible
	Shank type:	BMT
	Machine adaption:	Centering bolt ø 12
	Tool adaption:	Sq. 20
		Sq. 20
	Coolant:	IC/Ext
	Pressure max [bar]:	140
	Please note:	Key rail
<b>8 229 05 008</b>	<b>Tool holder C 3 IC</b>	
	Weight [kg]:	1.360
	Notation:	180° reversible
	Version:	right
	Shank type:	BMT
	Machine adaption:	Centering bolt ø 12
	Tool adaption:	heimatec Capto(TM) C 3
	Coolant:	IC
	Please note:	Check applicability; note tool length!
	Offset [mm]:	20

Part-#	Name	
<b>8 229 05 011</b>	<b>Tool holder C 3 IC</b>	
	Weight [kg]:	2.520
	Notation:	180° reversible
	Version:	right
	Shank type:	BMT
	Machine adaption:	Centering bolt ø 12
	Tool adaption:	heimatec Capto(TM) C 3
	Coolant:	IC
	Please note:	Check applicability; note tool length!
	Offset [mm]:	54
<b>8 229 34 000</b>	<b>Adapter for sensor Blum TC 54-10 T</b>	
	Weight [kg]:	0.530
	Shank size [mm]:	38.00
	Shank type:	BMT
	Tool adaption:	Blum TC54-10T
<b>8 240 05 067</b>	<b>Tool holder C 3 IC</b>	
	Weight [kg]:	3.250
	Notation:	180° reversible
	Version:	right
	Shank type:	BMT
	Machine adaption:	Centering bolt ø 12
	Tool adaption:	heimatec Capto(TM) C 3
	Coolant:	IC
	Please note:	Check applicability; note tool length!
	Center distance [mm]:	75
<b>8 240 05 068</b>	<b>Tool holder C 3 IC</b>	
	Weight [kg]:	2.790
	Notation:	180° reversible
	Version:	offset; right
	Shank type:	BMT
	Machine adaption:	Centering bolt ø 12
	Tool adaption:	heimatec Capto(TM) C 3
	Coolant:	IC
	Please note:	Check applicability; note tool length!
	Center distance [mm]:	75
<b>8 240 08 035</b>	<b>Boring bar holder Ø 32</b>	
	Weight [kg]:	2.840
	Notation:	offset, 180° reversible
	Shank type:	BMT
	Machine adaption:	Centering bolt ø 12
	Tool adaption:	Ø 32
	Coolant:	IC/Ext
	Center distance [mm]:	60
<b>8 249 05 010</b>	<b>Double tool holder C 3 IC</b>	
	Employment for:	Main- and sub spindle
	Version:	right
	Shank type:	BMT
	Machine adaption:	Centering bolt ø 12
	Tool adaption:	heimatec Capto(TM) C 3 heimatec Capto(TM) C 3
	Coolant:	IC

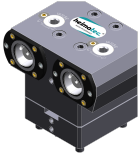
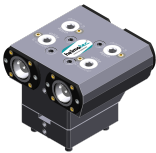
Part-#	Name	
	Please note: Center distance [mm]:	Check applicability; note tool length! 75
<b>8 250 05 005</b>	<b>Multiple tool holder C 3 IC</b>	
	Employment for: Version: Shank type: Machine adaption: Tool adaption:	Main- and sub spindle right BMT Centering bolt $\varnothing$ 12 heimatec Capto(TM) C 3 heimatec Capto(TM) C 3
	Coolant: Please note: Offset [mm]:	IC Check applicability; note tool length! 20 20
<b>8 250 05 009</b>	<b>Multiple tool holder C 3 IC</b>	
	Employment for: Version: Shank type: Machine adaption: Tool adaption:	Main- and sub spindle right BMT Centering bolt $\varnothing$ 12 heimatec Capto(TM) C 3 heimatec Capto(TM) C 3
	Coolant: Please note: Offset [mm]:	IC Check applicability; note tool length! 54 54
<b>8 251 01 000</b>	<b>Multiple turning holder sq. 16</b>	
	Weight [kg]: Employment for: Shank type: Machine adaption: Tool adaption:	3.800 Main- and sub spindle BMT Centering bolt $\varnothing$ 12 Sq. 16 Sq. 16
	Coolant: Please note:	EXT no coolant at 15°
<b>8 251 01 002</b>	<b>Multiple turning holder sq. 5/8"</b>	
	Weight [kg]: Employment for: Shank type: Machine adaption: Tool adaption:	3.810 Main- and sub spindle BMT Centering bolt $\varnothing$ 12 Sq. 5/8" (15,875mm) Sq. 5/8" (15,875mm)
	Coolant: Please note:	EXT no coolant at 15°
<b>8 253 07 008</b>	<b>Multiple boring bar holder <math>\varnothing</math> 25</b>	
	Weight [kg]: Notation: Shank type: Machine adaption: Tool adaption:	3.170 offset BMT Centering bolt $\varnothing$ 12 $\varnothing$ 25 $\varnothing$ 25
	Coolant: Please note:	IC/Ext no coolant at 15°

Part-#	Name	
	Center distance [mm]:	44/79
<b>8 253 07 018</b>	<b>Multiple boring bar holder Ø 1"</b>	
	Weight [kg]:	3.180
	Notation:	offset
	Shank type:	BMT
	Machine adaption:	Centering bolt ø 12
	Tool adaption:	Ø 1" (25,4mm)
		Ø 1" (25,4mm)
	Coolant:	IC/Ext
	Please note:	no coolant at 15°
	Center distance [mm]:	44/79
<b>8 253 07 048</b>	<b>Multiple boring bar holder Ø 25</b>	
	Weight [kg]:	2.810
	Notation:	offset
	Employment for:	Main- and sub spindle
	Shank type:	BMT
	Machine adaption:	Centering bolt ø 12
	Tool adaption:	Ø 25
		Ø 25
	Coolant:	IC/Ext
	Center distance [mm]:	44/79
<b>8 259 05 013</b>	<b>Multiple tool holder C 3 IC</b>	
	Notation:	180° reversible
	Version:	right; Y-axes offset
	Shank type:	BMT
	Machine adaption:	Centering bolt ø 12
	Tool adaption:	heimatec Capto(TM) C 3
		heimatec Capto(TM) C 3
	Coolant:	IC
	Please note:	Check applicability; note tool length!
	Center distance [mm]:	75
<b>8 259 05 014</b>	<b>Multiple tool holder C 3 IC</b>	
	Notation:	180° reversible
	Version:	right; offset; Y-axes offset
	Shank type:	BMT
	Machine adaption:	Centering bolt ø 12
	Tool adaption:	heimatec Capto(TM) C 3
		heimatec Capto(TM) C 3
	Coolant:	IC
	Please note:	Check applicability; note tool length!
	Center distance [mm]:	75
<b>8 259 05 015</b>	<b>Multiple tool holder C 3 IC</b>	
	Employment for:	Main- and sub spindle
	Version:	right; Y-axes offset
	Shank type:	BMT
	Machine adaption:	Centering bolt ø 12
	Tool adaption:	heimatec Capto(TM) C 3
		heimatec Capto(TM) C 3
		heimatec Capto(TM) C 3
		heimatec Capto(TM) C 3
	Coolant:	IC

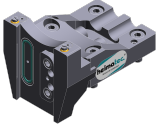
Part-#	Name	
	Please note:	Check applicability; note tool length!
	Center distance [mm]:	75
<b>8 259 05 022</b>	<b>Multiple tool holder C 3 IC</b>	
	Weight [kg]:	4.630
	Employment for:	Main- and sub spindle
	Version:	right; Y-axes offset
	Shank type:	BMT
	Machine adaption:	Centering bolt ø 12
	Tool adaption:	heimatec Capto(TM) C 3
		heimatec Capto(TM) C 3
		heimatec Capto(TM) C 3
		heimatec Capto(TM) C 3
	Coolant:	IC
	Please note:	Check applicability; note tool length! not
	Offset [mm]:	54
		54
<b>8 320 02 011</b>	<b>Cut-off holder, height adjustable SH 26 IC</b>	
	Weight [kg]:	1.370
	Notation:	180° reversible
	Shank type:	BMT
	Machine adaption:	Centering bolt ø 12
	Tool adaption:	Clampshaft SH 26
	Coolant:	IC/Ext
	Pressure max [bar]:	70
<b>8 320 02 016</b>	<b>Cut-off holder, height adjustable SH 26 IC</b>	
	Weight [kg]:	1.450
	Notation:	180° reversible
	Shank type:	BMT
	Machine adaption:	Centering bolt ø 12
	Tool adaption:	Clampshaft SH 26
	Coolant:	IC/Ext
	Pressure max [bar]:	70
	Please note:	Clampshaft internal
<b>8 320 03 019</b>	<b>Cut-off holder, height adjustable SH 32 IC</b>	
	Weight [kg]:	1.720
	Version:	Special
	Shank type:	BMT
	Machine adaption:	Centering bolt ø 12
	Tool adaption:	Clampshaft SH 32
	Coolant:	IC/Ext
	Pressure max [bar]:	70
	Please note:	with offset cut-off tool holder
<b>8 320 03 021</b>	<b>Cut-off holder, height adjustable SH 32 IC</b>	
	Weight [kg]:	1.470
	Shank type:	BMT
	Machine adaption:	Centering bolt ø 12
	Tool adaption:	Clampshaft SH 32
	Coolant:	IC/Ext
	Pressure max [bar]:	70

Part-#	Name	
<b>8 320 03 026</b>	<b>Cut-off holder, height adjustable SH 32 IC</b>	
	Weight [kg]:	1.620
	Notation:	180° reversible
	Shank type:	BMT
	Machine adaption:	Centering bolt ø 12
	Tool adaption:	Clampshaft SH 32
	Coolant:	IC/Ext
	Pressure max [bar]:	70
	Please note:	Clampshaft internal
<b>8 320 09 002</b>	<b>Cut-off holder, height adjustable 845 IC</b>	
	Weight [kg]:	1.380
	Notation:	180° reversible
	Shank type:	BMT
	Machine adaption:	Centering bolt ø 12
	Tool adaption:	 System 845
	Coolant:	IC
	Pressure max [bar]:	70





## heimatec.u-tec®

heimatec.com

Products / Tool change systems /  
u-tec® Tool-changing system



versions see catalog



## heimatec.easy-quick

heimatec.com

Products / Tool change systems /  
easy-quick HT quick-changing system



versions see catalog



## heimatec.Capto™

heimatec.com

Products / Tool change systems /  
heimatec.Capto™ quick-changing system



versions see catalog

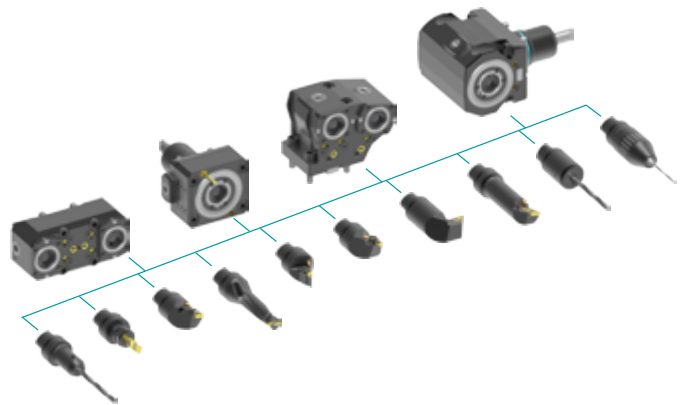

## heimatec.accessories

heimatec.com

Products / Accessories



versions see catalog





● heimatec overseas branches

○ global representations of heimatec

**heimatec**<sup>®</sup>

**heimatec GmbH**  
Präzisionswerkzeuge  
Carl-Benz-Str. 4  
77871 Renchen  
Germany

T +49 7843 9466 0  
[www.heimatec.com](http://www.heimatec.com)  
[info@heimatec.com](mailto:info@heimatec.com)

Please find the contact details of our worldwide trading partners on our website:  
<https://heimatec.com/business-partners>