

Hardinge

SUPER-PRECISION

T-65 - BMT-55



High-tech from heimatec - heimatec - Tools and systems for productive turning and milling

heimatec belongs to the international technology and quality leaders for precision tools and specializes in the development and production of high-precision static and live tools for all CNC lathes, CNC turn-/mill machines and CNC machining centers.

The range of products* spans from static BMT and VDI tool holders, live tools up to highly complex customer-specific individual solutions. heimatec, headquartered in Renchen, has a own subsidiary in Asia and India and numerous representatives as well as trading partners all over the world.

*OUR PRODCUTS

Static tool holders

Live tool units

Precision tools

Tools for turning and machining centres

Tools for swiss type lathes

Tool changing and uick-change systems

Tool systems for gear production

Digital tool management

This catalogue, including all its parts, is protected by copyright. Any use outside the restricted limitations of the Copyright Act without the consent of heimatec is inadmissible and liable to prosecution. This applies in particular to duplication, translation, microfilming and storage and processing in electronic systems.

heimatec GmbH reserves the right to make technical changes at any time without giving prior notice. This applies in particular to adjustments at any time to meet new or changed international standards, or in case of further developments of our products or manufacturing processes.

The current version of our General Terms and Conditions can be found on our website.

Part-#

Name

8 010 55 038**Axial drilling and milling head ER 25 AX UT IC**

Weight [kg]: 3.050
 Tool drive: Flat (~DIN 1809)
 Shank size [mm]: 55.00
 Shank type: BMT
 Tool adaption: ER 25 A - u-tec
 Gear ratio [i]: 1:1
 Torque max [Nm]: 50
 Rotation max [1/min]: 6000
 Rotating direction: same
 Coolant: IC/Ext
 Pressure max [bar]: 25
 Please note: Combi bearing

8 010 55 039**Axial drilling and milling head ER 25 AX UT**

Notation: 180° reversible
 Tool drive: Flat (~DIN 1809)
 Shank size [mm]: 55.00
 Shank type: BMT
 Tool adaption: ER 25 A - u-tec
 Gear ratio [i]: 1:1
 Torque max [Nm]: 50
 Rotation max [1/min]: 12000
 Rotating direction: same
 Coolant: EXT
 Pressure max [bar]: 140

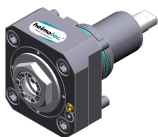

8 010 55 051**Axial drilling and milling head Weldon 3/4"**

Weight [kg]: 3.390
 Tool drive: Flat (~DIN 1809)
 Shank size [mm]: 55.00
 Shank type: BMT
 Tool adaption: Weldon (DIN 1835 b) 3/4" (19,05mm)
 Gear ratio [i]: 1:1
 Torque max [Nm]: 50
 Rotation max [1/min]: 6000
 Rotating direction: same
 Coolant: EXT
 Please note: Combi bearing

8 010 55 120**Axial drilling and milling head ER 25 AX UT**

Weight [kg]: 3.190
 Tool drive: Flat (~DIN 1809)
 Shank size [mm]: 55.00
 Shank type: BMT
 Tool adaption: ER 25 A - u-tec
 Gear ratio [i]: 1:1
 Torque max [Nm]: 50
 Rotation max [1/min]: 8000
 Rotating direction: same
 Coolant: EXT

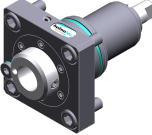
SUPER-PRECISION T-65 - BMT-55

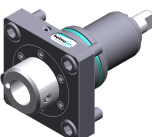
Part-#	Name	
8 010 56 035	Axial drilling and milling head HT 4 IC	
	Tool drive:	Flat (~DIN 1809)
	Shank size [mm]:	55.00
	Shank type:	BMT
	Tool adaption:	HT 4
	Gear ratio [i]:	1:1
	Torque max [Nm]:	50
	Rotation max [1/min]:	6000
	Rotating direction:	same
	Coolant:	IC/Ext
	Pressure max [bar]:	25
	Please note:	stronger bearing
8 010 56 039	Axial drilling and milling head ER 32 AX UT	
	Weight [kg]:	3.200
	Tool drive:	Flat (~DIN 1809)
	Shank size [mm]:	55.00
	Shank type:	BMT
	Tool adaption:	ER 32 A - u-tec
	Gear ratio [i]:	1:1
	Torque max [Nm]:	50
	Rotation max [1/min]:	6000
	Rotating direction:	same
	Coolant:	EXT
	Please note:	Combi bearing
8 010 56 040	Axial drilling and milling head ER 32 AX UT IC	
	Weight [kg]:	3.220
	Tool drive:	Flat (~DIN 1809)
	Shank size [mm]:	55.00
	Shank type:	BMT
	Tool adaption:	ER 32 A - u-tec
	Gear ratio [i]:	1:1
	Torque max [Nm]:	50
	Rotation max [1/min]:	6000
	Rotating direction:	same
	Coolant:	IC/Ext
	Pressure max [bar]:	25
	Please note:	Combi bearing
8 010 56 047	Axial drilling and milling head HT 4 IC	
	Tool drive:	Flat (~DIN 1809)
	Shank size [mm]:	55.00
	Shank type:	BMT
	Tool adaption:	HT 4
	Gear ratio [i]:	1:1
	Torque max [Nm]:	50
	Rotation max [1/min]:	6000
	Rotating direction:	same
	Coolant:	IC/Ext
	Pressure max [bar]:	25
	Please note:	Combi bearing

Part-#

Name

8 010 56 119**Axial drilling and milling head C 4 IC**

Notation:	180° reversible
Tool drive:	Flat (~DIN 1809)
Shank size [mm]:	55.00
Shank type:	BMT
Tool adaption:	heimatec Capto(TM) C 4
Gear ratio [i]:	1:1
Torque max [Nm]:	50
Rotation max [1/min]:	6000
Rotating direction:	same
Coolant:	IC/Ext
Pressure max [bar]:	100
Please note:	Check applicability; tool length check !;

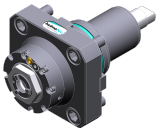
8 013 54 008**Axial drilling and milling head ER 16 AX UT**

Weight [kg]:	2.480
Tool drive:	Flat (~DIN 1809)
Shank size [mm]:	55.00
Shank type:	BMT
Tool adaption:	ER 16 A - u-tec
Gear ratio [i]:	1:4
Torque max [Nm]:	5
Rotation max [1/min]:	24000
Rotating direction:	same
Coolant:	EXT



8 013 54 009**Axial drilling and milling head ER 16 AX UT IC**

Tool drive:	Flat (~DIN 1809)
Shank size [mm]:	55.00
Shank type:	BMT
Tool adaption:	ER 16 A - u-tec
Gear ratio [i]:	1:4
Torque max [Nm]:	5
Rotation max [1/min]:	24000
Rotating direction:	same
Coolant:	IC/Ext
Pressure max [bar]:	100

8 019 55 050**Axial drilling and milling head ER 25 AX UT**

Weight [kg]:	5.000
Notation:	offset; 180° reversible
Tool drive:	Flat (~DIN 1809)
Shank size [mm]:	55.00
Shank type:	BMT
Tool adaption:	ER 25 A - u-tec
Gear ratio [i]:	1:1
Torque max [Nm]:	40
Rotation max [1/min]:	8000
Rotating direction:	opposite
Coolant:	EXT
Please note:	stronger bearing
Offset [mm]:	42

SUPER-PRECISION T-65 - BMT-55

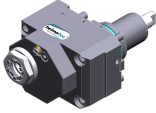
Part-#	Name	
8 019 55 051	Axial drilling and milling head ER 25 AX UT	
	Weight [kg]:	5.010
	Notation:	offset; 180° reversible
	Tool drive:	Flat (~DIN 1809)
	Shank size [mm]:	55.00
	Shank type:	BMT
	Tool adaption:	ER 25 A - u-tec
	Gear ratio [i]:	2:1
	Torque max [Nm]:	50
	Rotation max [1/min]:	3000
	Rotating direction:	opposite
	Coolant:	EXT
	Please note:	stronger bearing
	Offset [mm]:	42
8 019 55 052	Axial drilling and milling head ER 25 AX UT	
	Weight [kg]:	5.020
	Notation:	offset; 180° reversible
	Tool drive:	Flat (~DIN 1809)
	Shank size [mm]:	55.00
	Shank type:	BMT
	Tool adaption:	ER 25 A - u-tec
	Gear ratio [i]:	1:3
	Torque max [Nm]:	16
	Rotation max [1/min]:	18000
	Rotating direction:	opposite
	Coolant:	EXT
	Please note:	stronger bearing
	Offset [mm]:	42
8 019 55 053	Axial drilling and milling head ER 25 AX UT	
	Weight [kg]:	4.980
	Notation:	offset; 180° reversible
	Tool drive:	Flat (~DIN 1809)
	Shank size [mm]:	55.00
	Shank type:	BMT
	Tool adaption:	ER 25 A - u-tec
	Gear ratio [i]:	1:2
	Torque max [Nm]:	25
	Rotation max [1/min]:	16000
	Rotating direction:	opposite
	Coolant:	EXT
	Please note:	stronger bearing
	Offset [mm]:	42
8 019 55 054	Axial drilling and milling head ER 25 AX UT IC	
	Notation:	offset; 180° reversible
	Tool drive:	Flat (~DIN 1809)
	Shank size [mm]:	55.00
	Shank type:	BMT
	Tool adaption:	ER 25 A - u-tec
	Gear ratio [i]:	1:1
	Torque max [Nm]:	40
	Rotation max [1/min]:	6000
	Rotating direction:	opposite
	Coolant:	IC/Ext

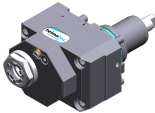
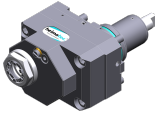
Part-#	Name	
	Pressure max [bar]:	140
	Please note:	stronger bearing
	Offset [mm]:	42
8 019 55 056	Axial drilling and milling head ER 25 AX UT IC	
	Weight [kg]:	6.130
	Notation:	offset; 180° reversible
	Tool drive:	Flat (~DIN 1809)
	Shank size [mm]:	55.00
	Shank type:	BMT
	Tool adaption:	ER 25 A - u-tec
	Gear ratio [i]:	1:3
	Torque max [Nm]:	16
	Rotation max [1/min]:	18000
	Rotating direction:	opposite
	Coolant:	IC/Ext
	Pressure max [bar]:	140
	Please note:	stronger bearing
	Offset [mm]:	42
8 019 55 057	Axial drilling and milling head ER 25 AX UT IC	
	Weight [kg]:	6.060
	Notation:	offset; 180° reversible
	Tool drive:	Flat (~DIN 1809)
	Shank size [mm]:	55.00
	Shank type:	BMT
	Tool adaption:	ER 25 A - u-tec
	Gear ratio [i]:	1:2
	Torque max [Nm]:	25
	Rotation max [1/min]:	16000
	Rotating direction:	opposite
	Coolant:	IC/Ext
	Pressure max [bar]:	140
	Please note:	stronger bearing
	Offset [mm]:	42
8 030 54 053	Radial drilling and milling head ER 16 AX UT IC	
	Weight [kg]:	7.290
	Notation:	180° reversible
	Tool drive:	Flat (~DIN 1809)
	Shank size [mm]:	55.00
	Shank type:	BMT
	Tool adaption:	ER 16 A - u-tec
	Gear ratio [i]:	1:4
	Torque max [Nm]:	5
	Rotation max [1/min]:	24000
	Rotating direction:	opposite
	Coolant:	IC/Ext
	Pressure max [bar]:	140
	Center distance [mm]:	70

Part-#

Name

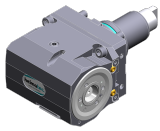
8 030 55 058**Radial drilling and milling head C 3**

Weight [kg]: 7.560
 Notation: 180° reversible
 Tool drive: Flat (~DIN 1809)
 Shank size [mm]: 55.00
 Shank type: BMT
 Tool adaption: heimatec Capto(TM) C 3
 Gear ratio [i]: 1:1
 Torque max [Nm]: 25
 Rotation max [1/min]: 8000
 Rotating direction: opposite
 Coolant: EXT
 Please note: Check applicability; note tool length!
 Center distance [mm]: 70

8 030 55 067**Radial drilling and milling head ER 25 AX UT IC**

Notation: 180° reversible
 Tool drive: Flat (~DIN 1809)
 Shank size [mm]: 55.00
 Shank type: BMT
 Tool adaption: ER 25 A - u-tec
 Gear ratio [i]: 1:3
 Torque max [Nm]: 12
 Rotation max [1/min]: 18000
 Rotating direction: same
 Coolant: IC/Ext
 Pressure max [bar]: 140
 Please note: stronger bearing
 Center distance [mm]: 80

8 030 55 102**Radial drilling and milling head ER 25 AX UT**

Weight [kg]: 6.900
 Notation: 180° reversible
 Tool drive: Flat (~DIN 1809)
 Shank size [mm]: 55.00
 Shank type: BMT
 Tool adaption: ER 25 A - u-tec
 Gear ratio [i]: 1:1
 Torque max [Nm]: 50
 Rotation max [1/min]: 12000
 Rotating direction: same
 Coolant: EXT
 Center distance [mm]: 70

8 030 55 120**Radial drilling and milling head ER 25 AX UT IC**

Tool drive: Flat (~DIN 1809)
 Shank size [mm]: 55.00
 Tool adaption: ER 25 A - u-tec
 Gear ratio [i]: 1:1
 Torque max [Nm]: 50
 Rotation max [1/min]: 12000
 Rotating direction: same
 Coolant: IC/Ext
 Pressure max [bar]: 140
 Center distance [mm]: 70

Part-#

Name

8 030 55 175**Radial drilling and milling head ER 25 AX UT**

Notation: 180° reversible
 Tool drive: Flat (~DIN 1809)
 Shank size [mm]: 55.00
 Shank type: BMT
 Tool adaption: ER 25 A - u-tec
 Gear ratio [i]: 1:1
 Torque max [Nm]: 50
 Rotation max [1/min]: 12000
 Rotating direction: same
 Coolant: EXT
 Please note: stronger bearing
 Center distance [mm]: 60

8 030 55 176**Radial drilling and milling head ER 25 AX UT IC**

Weight [kg]: 6.500
 Notation: 180° reversible
 Tool drive: Flat (~DIN 1809)
 Shank size [mm]: 55.00
 Shank type: BMT
 Tool adaption: ER 25 A - u-tec
 Gear ratio [i]: 1:1
 Torque max [Nm]: 50
 Rotation max [1/min]: 12000
 Rotating direction: same
 Coolant: IC/Ext
 Pressure max [bar]: 140
 Please note: stronger bearing
 Center distance [mm]: 60



8 030 56 052**Radial drilling and milling head ER 32 AX UT**

Tool drive: Flat (~DIN 1809)
 Shank size [mm]: 55.00
 Shank type: BMT
 Tool adaption: ER 32 A - u-tec
 Gear ratio [i]: 1:1
 Torque max [Nm]: 50
 Rotation max [1/min]: 6000
 Rotating direction: same
 Coolant: EXT
 Please note: stronger bearing
 Center distance [mm]: 70

8 030 56 056**Radial drilling and milling head ER 32 AX UT IC**

Weight [kg]: 7.150
 Notation: 180° reversible
 Tool drive: Flat (~DIN 1809)
 Shank size [mm]: 55.00
 Shank type: BMT
 Tool adaption: ER 32 A - u-tec
 Gear ratio [i]: 1:1
 Torque max [Nm]: 50
 Rotation max [1/min]: 12000
 Rotating direction: same
 Coolant: IC/Ext
 Pressure max [bar]: 140
 Center distance [mm]: 70

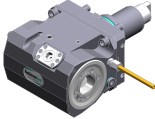
SUPER-PRECISION T-65 - BMT-55

Part-#	Name	
8 030 56 172	Radial drilling and milling head ER 32 AX UT IC	
	Weight [kg]:	6.830
	Notation:	180° reversible
	Tool drive:	Flat (~DIN 1809)
	Shank size [mm]:	55.00
	Shank type:	BMT
	Tool adaption:	ER 32 A - u-tec
	Gear ratio [i]:	2:1
	Torque max [Nm]:	63
	Rotation max [1/min]:	3000
	Rotating direction:	opposite
	Coolant:	IC/Ext
	Pressure max [bar]:	140
	Please note:	Combi bearing
	Center distance [mm]:	70
8 030 56 186	Radial drilling and milling head C 4	
	Weight [kg]:	10.200
	Notation:	180° reversible
	Tool drive:	Flat (~DIN 1809)
	Shank size [mm]:	55.00
	Shank type:	BMT
	Tool adaption:	heimatec Capto(TM) C 4
	Gear ratio [i]:	1:1
	Torque max [Nm]:	40
	Rotation max [1/min]:	6000
	Rotating direction:	opposite
	Coolant:	EXT
	Please note:	Check applicability; note tool length!
	Center distance [mm]:	85
8 030 56 187	Radial drilling and milling head C 4 IC	
	Weight [kg]:	10.440
	Notation:	180° reversible
	Tool drive:	Flat (~DIN 1809)
	Shank size [mm]:	55.00
	Shank type:	BMT
	Tool adaption:	heimatec Capto(TM) C 4
	Gear ratio [i]:	1:1
	Torque max [Nm]:	40
	Rotation max [1/min]:	6000
	Rotating direction:	opposite
	Coolant:	IC/Ext
	Pressure max [bar]:	140
	Please note:	Check applicability; note tool length!
	Center distance [mm]:	85
8 030 56 274	Radial drilling and milling head ER 32 AX UT	
	Weight [kg]:	6.720
	Notation:	180° reversible
	Tool drive:	Flat (~DIN 1809)
	Shank size [mm]:	55.00
	Shank type:	BMT
	Tool adaption:	ER 32 A - u-tec
	Gear ratio [i]:	1:1
	Torque max [Nm]:	50
	Rotation max [1/min]:	12000

Part-#

Name

Rotating direction: same
Coolant: EXT
Center distance [mm]: 70

8 037 54 024**Radial disk mill head arbor 16**

Weight [kg]: 11.300
Notation: 180° reversible
Version: ± 20° turnable; at 0° position can be pinned
Tool drive: Flat (~DIN 1809)
Shank size [mm]: 55.00
Shank type: BMT
Tool adaption: Arbor 16
Gear ratio [i]: 2:1
Torque max [Nm]: 63
Rotation max [1/min]: 3000
Rotating direction: same
Coolant: no
Please note: strong version with stronger bearing; use
Center distance [mm]: 83,5

8 037 54 025**Radial disk mill head arbor 16**

Version: 360° turnable
Tool drive: Flat (~DIN 1809)
Shank size [mm]: 55.00
Shank type: BMT
Tool adaption: Arbor 16
Gear ratio [i]: 1:1
Torque max [Nm]: 50
Rotation max [1/min]: 4000
Rotating direction: opposite
Coolant: EXT
Please note: Check applicability; note tool length;
Center distance [mm]: 89

8 037 55 039**Radial disk mill head arbor 1"**



Weight [kg]: 10.220
Tool drive: Flat (~DIN 1809)
Shank size [mm]: 55.00
Shank type: BMT
Tool adaption: Arbor 1" (25,4mm)
Gear ratio [i]: 2:1
Torque max [Nm]: 80
Rotation max [1/min]: 4000
Rotating direction: same
Coolant: EXT
Please note: Check applicability; note tool length;
Center distance [mm]: 81

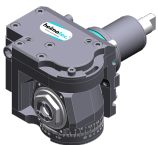

8 039 55 051**Radial drilling and milling head ER 25 AX UT**

Weight [kg]: 7.000
Version: double spindle
Tool drive: Flat (~DIN 1809)
Shank size [mm]: 55.00
Shank type: BMT
Tool adaption: ER 25 A - u-tec
Gear ratio [i]: 1:1

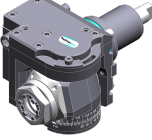
Part-#	Name	
	Torque max [Nm]:	50
	Rotation max [1/min]:	12000
	Rotating direction:	same/opposite
	Coolant:	EXT
	Center distance [mm]:	60
8 039 56 022	Radial drilling and milling head ER 32 AX UT	
	Weight [kg]:	7.000
	Notation:	180° reversible
	Employment for:	Main- and sub spindle
	Version:	double spindle
	Tool drive:	Flat (~DIN 1809)
	Shank size [mm]:	55.00
	Shank type:	BMT
	Tool adaption:	ER 32 A - u-tec
	Gear ratio [i]:	1:1
	Torque max [Nm]:	50
	Rotation max [1/min]:	6000
	Rotating direction:	same/opposite
	Coolant:	EXT
	Please note:	stronger bearing
	Center distance [mm]:	70
8 039 56 035	Radial drilling and milling head ER 32 AX UT	
	Weight [kg]:	6.970
	Notation:	180° reversible
	Employment for:	Main- and sub spindle
	Version:	double spindle, special
	Tool drive:	Flat (~DIN 1809)
	Shank size [mm]:	55.00
	Shank type:	BMT
	Tool adaption:	ER 32 A - u-tec
	Gear ratio [i]:	1:1
	Torque max [Nm]:	50
	Rotation max [1/min]:	6000
	Rotating direction:	same/opposite
	Coolant:	no
	Please note:	Operation only with air purge, no coolant
	Center distance [mm]:	70
8 043 54 006	Universal head +110°/-20° adj. ER16 AX UT	
	Weight [kg]:	5.940
	Notation:	offset; 180° reversible
	Tool drive:	Flat (~DIN 1809)
	Shank size [mm]:	55.00
	Shank type:	BMT
	Tool adaption:	ER 16 A - u-tec
	Gear ratio [i]:	1:1
	Torque max [Nm]:	25
	Rotation max [1/min]:	6000
	Rotating direction:	opposite
	Coolant:	EXT
	Center distance [mm]:	50
	Offset [mm]:	35



Part-#	Name	
8 043 54 013	Universal head +110°/-20° adj. ER16 AX UT	
	Weight [kg]:	6.320
	Notation:	offset; 180° reversible
	Tool drive:	Flat (~DIN 1809)
	Shank size [mm]:	55.00
	Shank type:	BMT
	Tool adaption:	ER 16 A - u-tec
	Gear ratio [i]:	1:2
	Torque max [Nm]:	12
	Rotation max [1/min]:	12000
	Rotating direction:	opposite
	Coolant:	EXT
	Center distance [mm]:	50
	Offset [mm]:	35
8 043 55 005	Universal head +110°/-20° adj. ER25 AX UT	
	Weight [kg]:	6.170
	Notation:	offset, 180° reversible
	Tool drive:	Flat (~DIN 1809)
	Shank size [mm]:	55.00
	Shank type:	BMT
	Tool adaption:	ER 25 A - u-tec
	Gear ratio [i]:	1:1
	Torque max [Nm]:	25
	Rotation max [1/min]:	6000
	Rotating direction:	opposite
	Coolant:	EXT
	Please note:	stronger bearing
	Center distance [mm]:	50
	Offset [mm]:	35
8 043 55 009	Universal head +110°/-20° adj. ER25AX UTIK	
	Weight [kg]:	6.320
	Notation:	offset, 180° reversible
	Tool drive:	Flat (~DIN 1809)
	Shank size [mm]:	55.00
	Shank type:	BMT
	Tool adaption:	ER 25 A - u-tec
	Gear ratio [i]:	1:1
	Torque max [Nm]:	25
	Rotation max [1/min]:	6000
	Rotating direction:	opposite
	Coolant:	IC/Ext
	Pressure max [bar]:	25
	Please note:	stronger bearing
	Center distance [mm]:	50
	Offset [mm]:	35
8 043 55 027	Universal head +110°/-20° adj. ER25 AX UT	
	Weight [kg]:	6.180
	Notation:	offset, 180° reversible
	Version:	at 45° position can be pinned
	Tool drive:	Flat (~DIN 1809)
	Shank size [mm]:	55.00
	Shank type:	BMT
	Tool adaption:	ER 25 A - u-tec



Part-#	Name	
	Gear ratio [i]:	1:1
	Torque max [Nm]:	25
	Rotation max [1/min]:	6000
	Rotating direction:	opposite
	Coolant:	EXT
	Please note:	stronger bearing
	Center distance [mm]:	50
	Offset [mm]:	35
8 053 54 030	Multispindle radial head ER 16 AXUT IC	
	Weight [kg]:	6.880
	Notation:	180° reversible
	Version:	2-spindles
	Tool drive:	Flat (~DIN 1809)
	Shank size [mm]:	55.00
	Shank type:	BMT
	Tool adaption:	ER 16 A - u-tec
	Gear ratio [i]:	1:2
	Torque max [Nm]:	8
	Rotation max [1/min]:	12000
	Rotating direction:	same
	Coolant:	IC/Ext
	Pressure max [bar]:	25
	Center distance [mm]:	70
8 200 02 003	Cover plate	
	Weight [kg]:	0.361
	Shank size [mm]:	55.00
	Shank type:	BMT
8 224 03 003	Cut-off holder SH 32	
	Weight [kg]:	1.810
	Notation:	180° reversible
	Employment for:	Cut-off tool 32
	Version:	Clampshaft on turret side
	Shank type:	BMT
	Machine adaption:	Centering key b 15
	Tool adaption:	Clampshaft SH 32
	Coolant:	EXT
8 224 04 002	Universal turning holder sq. 20	
	Weight [kg]:	3.460
	Shank type:	BMT
	Machine adaption:	Centering key b 15
	Tool adaption:	Sq. 20
	Coolant:	EXT

SUPER-PRECISION T-65 - BMT-55

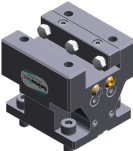
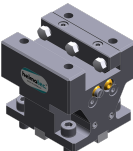

Part-#	Name	
8 224 04 062	Universal turning holder sq. 20 IC	
		Weight [kg]: 3.020 Shank type: BMT Machine adaption: Centering key b 15 Tool adaption: Sq. 20 Sq. 20 Coolant: IC/Ext Pressure max [bar]: 100 Please note: Key rail
8 224 05 003	Universal turning holder sq. 25	
		Weight [kg]: 3.620 Notation: 180° reversible Shank type: BMT Machine adaption: Centering key b 15 Tool adaption: Sq. 25 Coolant: EXT
8 224 05 005	Universal turning holder sq. 1"	
		Weight [kg]: 3.560 Shank type: BMT Machine adaption: Centering key b 15 Tool adaption: Sq. 1" (25,4mm) Coolant: EXT
8 224 05 015	Universal turning holder sq. 25/20	
		Weight [kg]: 3.780 Notation: 180° reversible Shank type: BMT Machine adaption: Centering key b 15 Tool adaption: Sq. 25/20 Coolant: EXT Pressure max [bar]: 80 Please note: with spacer strip for sq. 20
8 224 05 023	Universal turning holder sq. 25/20	
		Weight [kg]: 3.150 Notation: 180° reversible Shank type: BMT Machine adaption: Centering key b 15 Tool adaption: Sq. 25/20 Coolant: EXT Please note: with spacer strip for sq. 20
8 240 07 069	Boring bar holder Ø 25	
		Notation: 180° reversible Employment for: Main- and sub spindle Shank type: BMT Machine adaption: Centering key b 15 Tool adaption: Ø 25 Coolant: IC/Ext Center distance [mm]: 70

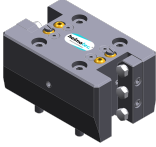
SUPER-PRECISION T-65 - BMT-55

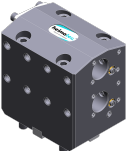
Part-#	Name	
8 240 08 009	Boring bar holder Ø 1 1/2"	
	Weight [kg]:	5.470
	Notation:	180° reversible
	Employment for:	Main- and sub spindle
	Shank type:	BMT
	Machine adaption:	Centering key b 15
	Tool adaption:	Ø 1 1/2" (38,1mm)
	Coolant:	IC/Ext
	Center distance [mm]:	70
8 240 08 061	Boring bar holder Ø 32	
	Weight [kg]:	6.490
	Notation:	180° reversible
	Employment for:	Main- and sub spindle
	Shank type:	BMT
	Machine adaption:	Centering key b 15
	Tool adaption:	Ø 32
	Coolant:	IC/Ext
	Center distance [mm]:	80
8 240 09 009	Boring bar holder Ø 40	
	Weight [kg]:	5.640
	Notation:	180° reversible
	Employment for:	Main- and sub spindle
	Shank type:	BMT
	Machine adaption:	Centering key b 15
	Tool adaption:	Ø 40
	Coolant:	IC/Ext
	Pressure max [bar]:	80
	Center distance [mm]:	70
8 244 05 003	Combi facing holder sq. 25	
	Weight [kg]:	5.340
	Notation:	180° reversible
	Employment for:	Main- and sub spindle
	Shank type:	BMT
	Machine adaption:	Centering key b 15
	Tool adaption:	Sq. 25
	Coolant:	EXT
	Pressure max [bar]:	80
8 244 05 006	Combi facing holder sq. 1"	
	Weight [kg]:	5.310
	Notation:	180° reversible
	Employment for:	Main- and sub spindle
	Shank type:	BMT
	Machine adaption:	Centering key b 15
	Tool adaption:	Sq. 1" (25,4mm)
	Coolant:	EXT

Part-#	Name	
8 251 05 001	Combi double turning holder sq. 25	
	Weight [kg]:	7.700
	Employment for:	Main- and sub spindle
	Shank type:	BMT
	Machine adaption:	Centering key b 15
	Tool adaption:	Sq. 25
		Sq. 25
		Sq. 25
		Sq. 25
	Coolant:	EXT
	Pressure max [bar]:	80
8 253 07 011	Double boring bar holder Ø 25	
	Weight [kg]:	6.770
	Notation:	180° reversible
	Employment for:	Main- and sub spindle
	Shank type:	BMT
	Machine adaption:	Centering key b 15
	Tool adaption:	Ø 25
		Ø 25
	Coolant:	IC/Ext
	Pressure max [bar]:	80
	Please note:	Check applicability; note tool length
	Center distance [mm]:	52/97
8 253 07 031	Double boring bar holder Ø 1"	
	Weight [kg]:	7.620
	Notation:	180° reversible
	Employment for:	Main- and sub spindle
	Shank type:	BMT
	Machine adaption:	Centering key b 15
	Tool adaption:	Ø 1" (25,4mm)
		Ø 1" (25,4mm)
	Coolant:	IC/Ext
	Center distance [mm]:	52/97
8 253 07 047	Double boring bar holder Ø 25	
	Weight [kg]:	6.940
	Notation:	180° reversible
	Employment for:	Main- and sub spindle
	Shank type:	BMT
	Machine adaption:	Centering key b 15
	Tool adaption:	Ø 25
		Ø 25
	Coolant:	IC/Ext
	Center distance [mm]:	44/87
8 253 08 002	Double boring bar holder Ø 32	
	Weight [kg]:	6.340
	Notation:	180° reversible
	Employment for:	Main- and sub spindle
	Shank type:	BMT
	Machine adaption:	Centering key b 15
	Tool adaption:	Ø 32
		Ø 32
	Coolant:	IC/Ext
	Center distance [mm]:	44/87

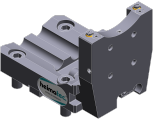
SUPER-PRECISION T-65 - BMT-55

Part-#	Name	
8 259 04 007	Multiple turning holder sq. 20	
	Weight [kg]:	8.180
	Notation:	180° reversible
	Employment for:	Main- and sub spindle
	Version:	Special
	Shank type:	BMT
	Machine adaption:	Centering key b 15
	Tool adaption:	Sq. 20
		Sq. 20
		Sq. 20
	Coolant:	IC/Ext
8 320 03 025	Cut-off holder, height adjustable SH 32 IC	
	Weight [kg]:	1.910
	Notation:	180° reversible
	Shank type:	BMT
	Machine adaption:	Centering key b 15
	Tool adaption:	Clampshaft SH 32
	Coolant:	IC/Ext
	Pressure max [bar]:	70
	Please note:	Clampshaft internal
8 320 09 001	Cut-off holder, height adjustable 845 IC	
	Weight [kg]:	1.730
	Notation:	180° reversible
	Shank type:	BMT
	Machine adaption:	Centering key b 15
	Tool adaption:	 System 845
	Coolant:	IC
	Pressure max [bar]:	70

heimatec.u-tec®

heimatec.com

Products / Tool change systems /
u-tec® Tool-changing system



versions see catalog

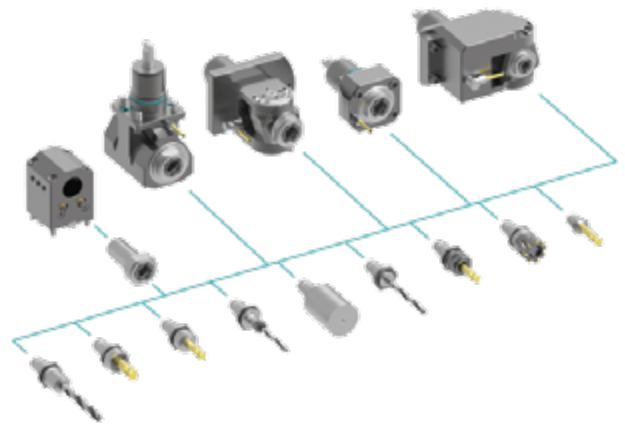

heimatec.easy-quick

heimatec.com

Products / Tool change systems /
easy-quick HT quick-changing system



versions see catalog

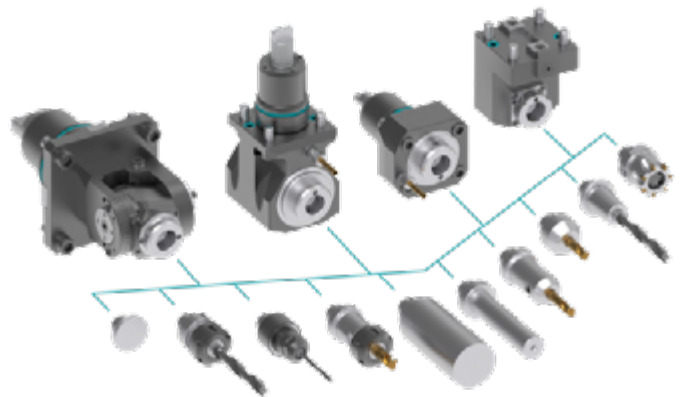

heimatec.Capto™

heimatec.com

Products / Tool change systems /
heimatec.Capto™ quick-changing system



versions see catalog

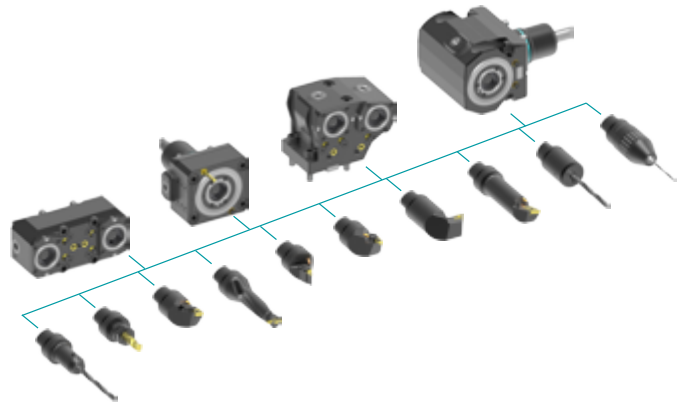

heimatec.accessories

heimatec.com

Products / Accessories



versions see catalog





● heimatec overseas branches

○ global representations of heimatec

heimatec[®]

heimatec GmbH
Präzisionswerkzeuge
Carl-Benz-Str. 4
77871 Renchen
Germany

T +49 7843 9466 0
www.heimatec.com
info@heimatec.com

Please find the contact details of our worldwide trading partners on our website:
<https://heimatec.com/business-partners>