

Miyano

BND 51 S/SY2



High-tech from heimatec - heimatec - Tools and systems for productive turning and milling

heimatec belongs to the international technology and quality leaders for precision tools and specializes in the development and production of high-precision static and live tools for all CNC lathes, CNC turn-/mill machines and CNC machining centers.

The range of products* spans from static BMT and VDI tool holders, live tools up to highly complex customer-specific individual solutions. heimatec, headquartered in Renchen, has a own subsidiary in Asia and India and numerous representatives as well as trading partners all over the world.

*OUR PRODCUTS

Static tool holders

Live tool units

Precision tools

Tools for turning and machining centres

Tools for swiss type lathes

Tool changing and uick-change systems

Tool systems for gear production

Digital tool management

This catalogue, including all its parts, is protected by copyright. Any use outside the restricted limitations of the Copyright Act without the consent of heimatec is inadmissible and liable to prosecution. This applies in particular to duplication, translation, microfilming and storage and processing in electronic systems.

heimatec GmbH reserves the right to make technical changes at any time without giving prior notice. This applies in particular to adjustments at any time to meet new or changed international standards, or in case of further developments of our products or manufacturing processes.

The current version of our General Terms and Conditions can be found on our website.

Part-#	Name
--------	------

8 010 45 047



Axial drilling and milling head ER 25 M

Weight [kg]: 1.740
 Tool drive: Flat (~DIN 1809)
 Shank size [mm]: 45.00
 Tool adaption: ER 25 M
 Gear ratio [i]: 1:1
 Torque max [Nm]: 50
 Rotation max [1/min]: 6000
 Rotating direction: same
 Coolant: EXT

8 010 45 050



Axial drilling and milling head ER 25 M IC

Weight [kg]: 2.000
 Tool drive: Flat (~DIN 1809)
 Shank size [mm]: 45.00
 Shank type: BMT
 Tool adaption: ER 25
 Gear ratio [i]: 1:1
 Torque max [Nm]: 50
 Rotation max [1/min]: 6000
 Rotating direction: same
 Coolant: IC/Ext
 Pressure max [bar]: 25

8 010 45 061

Axial drilling and milling head ER 25



Weight [kg]: 1.780
 Tool drive: Flat (~DIN 1809)
 Shank size [mm]: 45.00
 Shank type: BMT
 Tool adaption: ER 25
 Gear ratio [i]: 1:1
 Torque max [Nm]: 50
 Rotation max [1/min]: 6000
 Rotating direction: same
 Coolant: EXT

8 010 45 096



Axial drilling and milling head ER 25 AX UT IC

Weight [kg]: 2.000
 Tool drive: Flat (~DIN 1809)
 Shank size [mm]: 45.00
 Shank type: BMT
 Tool adaption: ER 25 A - u-tec
 Gear ratio [i]: 1:1
 Torque max [Nm]: 50
 Rotation max [1/min]: 6000
 Rotating direction: same
 Coolant: IC/Ext
 Pressure max [bar]: 25
 Please note: Combi bearing

Part-#	Name	
8 010 45 103	Axial milling and drill holder ER 25 AX UT	
	Weight [kg]:	1.870
	Tool drive:	Flat (~DIN 1809)
	Shank size [mm]:	45.00
	Shank type:	BMT
	Tool adaption:	ER 25 A - u-tec
	Gear ratio [i]:	1:1
	Torque max [Nm]:	50
	Rotation max [1/min]:	6000
	Rotating direction:	same
	Coolant:	EXT
	Please note:	Combi bearing
8 010 45 181	Axial drilling and milling head C 3 IC	
	Notation:	180° reversible
	Tool drive:	Flat (~DIN 1809)
	Shank size [mm]:	45.00
	Shank type:	BMT
	Tool adaption:	heimatec Capto(TM) C 3
	Gear ratio [i]:	1:1
	Torque max [Nm]:	25
	Rotation max [1/min]:	8000
	Rotating direction:	same
	Coolant:	IC/Ext
	Pressure max [bar]:	100
	Please note:	Check applicability; tool length check !
8 010 45 183	Axial drilling and milling head C 3	
	Weight [kg]:	3.800
	Notation:	180° reversible
	Tool drive:	Flat (~DIN 1809)
	Shank size [mm]:	45.00
	Shank type:	BMT
	Tool adaption:	heimatec Capto(TM) C 3
	Gear ratio [i]:	1:1
	Torque max [Nm]:	32
	Rotation max [1/min]:	8000
	Rotating direction:	same
	Coolant:	EXT
	Please note:	Check applicability; tool length check !
8 010 45 224	Axial drilling and milling head ER 25 AX UT	
	Weight [kg]:	1.900
	Tool drive:	Flat (~DIN 1809)
	Shank size [mm]:	45.00
	Shank type:	BMT
	Tool adaption:	ER 25 A - u-tec
	Gear ratio [i]:	1:1
	Torque max [Nm]:	50
	Rotation max [1/min]:	15000
	Rotating direction:	same
	Coolant:	EXT

Part-#	Name		
	8 010 45 225	Axial drilling and milling head ER 25 AX UT IC	
		Weight [kg]:	2.100
		Tool drive:	Flat (~DIN 1809)
		Shank size [mm]:	45.00
		Shank type:	BMT
		Tool adaption:	ER 25 A - u-tec
		Gear ratio [i]:	1:1
		Torque max [Nm]:	50
		Rotation max [1/min]:	12000
		Rotating direction:	same
		Coolant:	IC/Ext
		Pressure max [bar]:	100
		Please note:	Dryrun possible
8 010 46 092	Axial drilling and milling head HT 4		
		Weight [kg]:	1.700
		Tool drive:	Flat (~DIN 1809)
		Shank size [mm]:	45.00
		Shank type:	BMT
		Tool adaption:	HT 4
		Gear ratio [i]:	1:1
		Torque max [Nm]:	50
		Rotation max [1/min]:	6000
		Rotating direction:	same
	Coolant:	EXT	
8 010 46 112	Axial drilling and milling head HT 4 IC		
		Weight [kg]:	1.980
		Tool drive:	Flat (~DIN 1809)
		Shank size [mm]:	45.00
		Shank type:	BMT
		Tool adaption:	HT 4
		Gear ratio [i]:	1:1
		Torque max [Nm]:	50
		Rotation max [1/min]:	6000
		Rotating direction:	same
	Coolant:	IC/Ext	
	Pressure max [bar]:	25	
8 010 46 206	Axial drilling and milling head ER 32 AX UT		
		Weight [kg]:	2.110
		Version:	Special
		Tool drive:	Flat (~DIN 1809)
		Shank size [mm]:	45.00
		Shank type:	BMT
		Tool adaption:	ER 32 A - u-tec
		Gear ratio [i]:	1:1
		Torque max [Nm]:	50
		Rotation max [1/min]:	6000
		Rotating direction:	same
	Coolant:	EXT	
	Please note:	stronger bearing	

Part-#	Name	
	8 011 44 010	Axial milling head universal arbor 16
	Weight [kg]:	1.820
	Tool drive:	Flat (~DIN 1809)
	Shank size [mm]:	45.00
	Shank type:	BMT
	Tool adaption:	Universal arbor 16
	Gear ratio [i]:	1:1
	Torque max [Nm]:	50
	Rotation max [1/min]:	6000
	Rotating direction:	same
Coolant:	EXT	
Please note:	Taper roller bearings	
	8 011 44 021	Axial milling head universal arbor 3/4"
	Weight [kg]:	1.840
	Tool drive:	Flat (~DIN 1809)
	Shank size [mm]:	45.00
	Shank type:	BMT
	Tool adaption:	Universal arbor 3/4" (19,05mm)
	Gear ratio [i]:	1:1
	Torque max [Nm]:	50
	Rotation max [1/min]:	6000
	Rotating direction:	same
Coolant:	EXT	
Please note:	Taper roller bearings	
	8 011 45 018	Axial milling head universal arbor 22
	Weight [kg]:	1.940
	Tool drive:	Flat (~DIN 1809)
	Shank size [mm]:	45.00
	Shank type:	BMT
	Tool adaption:	Universal arbor 22
	Gear ratio [i]:	1:1
	Torque max [Nm]:	50
	Rotation max [1/min]:	6000
	Rotating direction:	same
Coolant:	EXT	
Please note:	Taper roller bearings	
	8 013 44 022	Axial drilling and milling head ER 16 AX UT
	Weight [kg]:	2.350
	Tool drive:	Flat (~DIN 1809)
	Shank size [mm]:	45.00
	Shank type:	BMT
	Tool adaption:	ER 16 A - u-tec
	Gear ratio [i]:	1:4
	Torque max [Nm]:	5
	Rotation max [1/min]:	24000
	Rotating direction:	same
Coolant:	EXT	

Part-#	Name	
8 013 44 023	Axial drilling and milling head ER 16 AX UT IC	
	Weight [kg]:	2.450
	Tool drive:	Flat (~DIN 1809)
	Shank size [mm]:	45.00
	Shank type:	BMT
	Tool adaption:	ER 16 A - u-tec
	Gear ratio [i]:	1:4
	Torque max [Nm]:	5
	Rotation max [1/min]:	24000
	Rotating direction:	same
	Coolant:	IC/Ext
	Pressure max [bar]:	100
	Please note:	Dryrun possible
8 019 44 012	Axial drilling and milling head ER 20	
	Weight [kg]:	4.020
	Notation:	offset
	Tool drive:	Flat (~DIN 1809)
	Shank size [mm]:	45.00
	Shank type:	BMT
	Tool adaption:	ER 20
	Gear ratio [i]:	1:2
	Torque max [Nm]:	12
	Rotation max [1/min]:	12000
	Rotating direction:	opposite
	Coolant:	EXT
8 019 44 019	Axial drilling and milling head ER 16 AX UT	
	Weight [kg]:	4.260
	Notation:	offset
	Tool drive:	Flat (~DIN 1809)
	Shank size [mm]:	45.00
	Shank type:	BMT
	Tool adaption:	ER 16 A - u-tec
	Gear ratio [i]:	1:2
	Torque max [Nm]:	12
	Rotation max [1/min]:	10000
	Rotating direction:	opposite
	Coolant:	EXT
	Please note:	stronger bearing
8 019 44 020	Axial drilling and milling head ER 16 M	
	Weight [kg]:	3.960
	Notation:	offset
	Tool drive:	Flat (~DIN 1809)
	Shank size [mm]:	45.00
	Shank type:	BMT
	Tool adaption:	ER 16
	Gear ratio [i]:	1:3
	Torque max [Nm]:	10
	Rotation max [1/min]:	15000
	Rotating direction:	opposite
	Coolant:	EXT
	Offset [mm]:	34,5

Part-#	Name	
8 019 44 060	Axial drilling and milling head ER 20	
	Weight [kg]:	4.000
	Notation:	offset
	Tool drive:	Flat (~DIN 1809)
	Shank size [mm]:	45.00
	Shank type:	BMT
	Tool adaption:	ER 20
	Gear ratio [i]:	1:3
	Torque max [Nm]:	10
	Rotation max [1/min]:	15000
	Rotating direction:	opposite
	Coolant:	EXT
	Offset [mm]:	34,5
8 019 44 073	Axial drilling and milling head ER 20 AX UT IC	
	Weight [kg]:	4.910
	Notation:	offset; 180° reversible
	Tool drive:	Flat (~DIN 1809)
	Shank size [mm]:	45.00
	Shank type:	BMT
	Tool adaption:	ER 20 A - u-tec
	Gear ratio [i]:	1:2
	Torque max [Nm]:	16
	Rotation max [1/min]:	12000
	Rotating direction:	opposite
	Coolant:	IC/Ext
	Pressure max [bar]:	140
	Please note:	stronger bearing
	Offset [mm]:	34,5
8 019 44 078	Axial drilling and milling head ER 16 AX UT	
	Weight [kg]:	3.890
	Notation:	offset
	Tool drive:	Flat (~DIN 1809)
	Shank size [mm]:	45.00
	Shank type:	BMT
	Tool adaption:	ER 16 A - u-tec
	Gear ratio [i]:	1:3
	Torque max [Nm]:	10
	Rotation max [1/min]:	15000
	Rotating direction:	opposite
	Coolant:	EXT
	Offset [mm]:	34,5
8 019 44 114	Axial drilling and milling head ER 20 AX UT	
	Notation:	offset; 180° reversible
	Tool drive:	Flat (~DIN 1809)
	Shank size [mm]:	45.00
	Shank type:	BMT
	Tool adaption:	ER 20 A - u-tec
	Gear ratio [i]:	1:2
	Torque max [Nm]:	16
	Rotation max [1/min]:	12000
	Rotating direction:	opposite
	Coolant:	EXT
	Please note:	stronger bearing
	Offset [mm]:	34,5

Part-#	Name	
8 019 45 093	Axial drilling and milling head ER 25 AX UT IC	
	Weight [kg]:	5.860
	Notation:	offset; 180° reversible
	Tool drive:	Flat (~DIN 1809)
	Shank size [mm]:	45.00
	Shank type:	BMT
	Tool adaption:	ER 25 A - u-tec
	Gear ratio [i]:	2:1
	Torque max [Nm]:	50
	Rotation max [1/min]:	3000
	Rotating direction:	same
	Coolant:	IC/Ext
	Pressure max [bar]:	140
	Please note:	stronger bearing
	Offset [mm]:	69
8 019 45 102	Axial drilling and milling head ER 25 AX UT	
	Weight [kg]:	5.400
	Notation:	offset; 180° reversible
	Tool drive:	Flat (~DIN 1809)
	Shank size [mm]:	45.00
	Shank type:	BMT
	Tool adaption:	ER 25 A - u-tec
	Gear ratio [i]:	2:1
	Torque max [Nm]:	50
	Rotation max [1/min]:	3000
	Rotating direction:	same
	Coolant:	EXT
	Please note:	stronger bearing
	Offset [mm]:	69
8 030 44 082	Radial drilling and milling head ER 16 AX UT	
	Notation:	180° reversible
	Tool drive:	Flat (~DIN 1809)
	Shank size [mm]:	45.00
	Shank type:	BMT
	Tool adaption:	ER 16 A - u-tec
	Gear ratio [i]:	1:4
	Torque max [Nm]:	5
	Rotation max [1/min]:	24000
	Rotating direction:	opposite
	Coolant:	EXT
	Center distance [mm]:	65
8 030 44 099	Radial drilling and milling head ER 16 AX UT IC	
	Weight [kg]:	4.900
	Notation:	180° reversible
	Tool drive:	Flat (~DIN 1809)
	Shank size [mm]:	45.00
	Shank type:	BMT
	Tool adaption:	ER 16 A - u-tec
	Gear ratio [i]:	1:4
	Torque max [Nm]:	5
	Rotation max [1/min]:	24000
	Rotating direction:	opposite
	Coolant:	IC/Ext
	Pressure max [bar]:	140
	Center distance [mm]:	65

Part-#	Name	
8 030 44 109	Radial drilling and milling head ER 20 AX UT IC	
	Weight [kg]:	5.950
	Notation:	180° reversible
	Tool drive:	Flat (~DIN 1809)
	Shank size [mm]:	45.00
	Shank type:	BMT
	Tool adaption:	ER 20 A - u-tec
	Gear ratio [i]:	1:2
	Torque max [Nm]:	16
	Rotation max [1/min]:	12000
	Rotating direction:	same
	Coolant:	IC/Ext
	Pressure max [bar]:	140
	Please note:	stronger bearing
	Center distance [mm]:	77
8 030 45 096	Radial drilling and milling head ER 25	
	Weight [kg]:	5.190
	Notation:	180° reversible
	Tool drive:	Flat (~DIN 1809)
	Shank size [mm]:	45.00
	Shank type:	BMT
	Tool adaption:	ER 25
	Gear ratio [i]:	1:2
	Torque max [Nm]:	12
	Rotation max [1/min]:	12000
	Rotating direction:	opposite
	Coolant:	EXT
	Center distance [mm]:	65
8 030 45 101	Radial drilling and milling head ER 25 IC	
	Weight [kg]:	5.450
	Notation:	180° reversible
	Tool drive:	Flat (~DIN 1809)
	Shank size [mm]:	45.00
	Shank type:	BMT
	Tool adaption:	ER 25
	Gear ratio [i]:	1:2
	Torque max [Nm]:	12
	Rotation max [1/min]:	12000
	Rotating direction:	opposite
	Coolant:	IC/Ext
	Pressure max [bar]:	140
	Center distance [mm]:	65
8 030 45 120	Radial drilling and milling head ER 25	
	Weight [kg]:	5.400
	Notation:	180° reversible
	Tool drive:	Flat (~DIN 1809)
	Shank size [mm]:	45.00
	Shank type:	BMT
	Tool adaption:	ER 25
	Gear ratio [i]:	1:1
	Torque max [Nm]:	50
	Rotation max [1/min]:	12000
	Rotating direction:	opposite
	Coolant:	EXT
	Center distance [mm]:	65

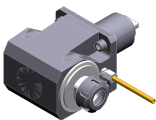

Part-#	Name
--------	------

8 030 45 121	Radial drilling and milling head ER 25 IC
Weight [kg]:	5.570
Notation:	180° reversible
Tool drive:	Flat (~DIN 1809)
Shank size [mm]:	45.00
Shank type:	BMT
Tool adaption:	ER 25
Gear ratio [i]:	1:1
Torque max [Nm]:	50
Rotation max [1/min]:	12000
Rotating direction:	opposite
Coolant:	IC/Ext
Pressure max [bar]:	140
Please note:	strong version
Center distance [mm]:	65



8 030 45 136	Radial drilling and milling head ER 25 AX UT IC
Weight [kg]:	5.370
Notation:	180° reversible
Tool drive:	Flat (~DIN 1809)
Shank size [mm]:	45.00
Shank type:	BMT
Tool adaption:	ER 25 A - u-tec
Gear ratio [i]:	1:1
Torque max [Nm]:	50
Rotation max [1/min]:	12000
Rotating direction:	opposite
Coolant:	IC/Ext
Pressure max [bar]:	140
Center distance [mm]:	65



8 030 45 163	Angle-mill- and drill holder ER 25 AX UT
Weight [kg]:	5.700
Notation:	180° reversible
Tool drive:	Flat (~DIN 1809)
Shank size [mm]:	45.00
Tool adaption:	ER 25 A - u-tec
Gear ratio [i]:	1:1
Torque max [Nm]:	50
Rotation max [1/min]:	6000
Rotating direction:	opposite
Coolant:	EXT
Please note:	Combi bearing
Center distance [mm]:	65

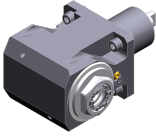

8 030 45 167	Radial drilling and milling head ER 25 AX UT
Weight [kg]:	5.790
Notation:	180° reversible
Tool drive:	Flat (~DIN 1809)
Shank size [mm]:	45.00
Shank type:	BMT
Tool adaption:	ER 25 A - u-tec
Gear ratio [i]:	1:3
Torque max [Nm]:	12
Rotation max [1/min]:	18000
Rotating direction:	same
Coolant:	EXT

Part-#	Name	
	Please note:	stronger bearing
	Center distance [mm]:	77
8 030 45 169	Radial drilling and milling head ER 25 AX UT	
	Weight [kg]:	5.340
	Notation:	180° reversible
	Tool drive:	Flat (~DIN 1809)
	Shank size [mm]:	45.00
	Shank type:	BMT
	Tool adaption:	ER 25 A - u-tec
	Gear ratio [i]:	1:1
	Torque max [Nm]:	50
	Rotation max [1/min]:	12000
	Rotating direction:	opposite
	Coolant:	EXT
	Center distance [mm]:	65
8 030 45 198	Angle-mill- and drill holder ER 25 AX UT IC	
	Weight [kg]:	5.800
	Notation:	180° reversible
	Tool drive:	Flat (~DIN 1809)
	Shank size [mm]:	45.00
	Shank type:	BMT
	Tool adaption:	ER 25 A - u-tec
	Gear ratio [i]:	1:1
	Torque max [Nm]:	50
	Rotation max [1/min]:	6000
	Rotating direction:	opposite
	Coolant:	IC/Ext
	Pressure max [bar]:	140
	Please note:	Combi bearing
	Center distance [mm]:	65
8 030 45 211	Radial drilling and milling head ER 25 AX UT	
	Weight [kg]:	5.770
	Notation:	180° reversible
	Tool drive:	Flat (~DIN 1809)
	Shank size [mm]:	45.00
	Shank type:	BMT
	Tool adaption:	ER 25 A - u-tec
	Gear ratio [i]:	1:2
	Torque max [Nm]:	16
	Rotation max [1/min]:	12000
	Rotating direction:	same
	Coolant:	EXT
	Please note:	stronger bearing
	Center distance [mm]:	77
8 030 45 239	Radial drilling and milling head ER 25 AX UT IC	
	Weight [kg]:	5.990
	Notation:	180° reversible
	Tool drive:	Flat (~DIN 1809)
	Shank size [mm]:	45.00
	Shank type:	BMT
	Tool adaption:	ER 25 A - u-tec
	Gear ratio [i]:	1:3
	Torque max [Nm]:	12

Part-#	Name
--------	------

Rotation max [1/min]: 18000
 Rotating direction: same
 Coolant: IC/Ext
 Pressure max [bar]: 140
 Please note: stronger bearing
 Center distance [mm]: 77

8 030 45 253 Radial drilling and milling head ER 25 AX UT

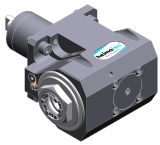

Weight [kg]: 5.480
 Notation: 180° reversible
 Tool drive: Flat (~DIN 1809)
 Shank size [mm]: 45.00
 Shank type: BMT
 Tool adaption: ER 25 A - u-tec
 Gear ratio [i]: 2:1
 Torque max [Nm]: 63
 Rotation max [1/min]: 3000
 Rotating direction: opposite
 Coolant: EXT
 Please note: Combi bearing
 Center distance [mm]: 65

8 030 45 346 Radial drilling and milling head C 3 IC





Notation: 180° reversible
 Tool drive: Flat (~DIN 1809)
 Shank size [mm]: 45.00
 Shank type: BMT
 Tool adaption: heimatec Capto(TM) C 3
 Gear ratio [i]: 1:1
 Torque max [Nm]: 25
 Rotation max [1/min]: 8000
 Rotating direction: opposite
 Coolant: IC/Ext
 Pressure max [bar]: 140
 Please note: Check applicability; note tool length!
 Center distance [mm]: 65

8 030 45 351 Radial drilling and milling head C 3

Notation: 180° reversible
 Tool drive: Flat (~DIN 1809)
 Shank size [mm]: 45.00
 Shank type: BMT
 Tool adaption: heimatec Capto(TM) C 3
 Gear ratio [i]: 1:1
 Torque max [Nm]: 25
 Rotation max [1/min]: 8000
 Rotating direction: opposite
 Coolant: EXT
 Please note: Check applicability; note tool length!
 Center distance [mm]: 65



Part-#	Name	
8 030 45 563	Radial drilling and milling head Weldon 16	
	Weight [kg]:	5.850
	Notation:	180° reversible
	Tool drive:	Flat (~DIN 1809)
	Shank size [mm]:	45.00
	Shank type:	BMT
	Tool adaption:	Weldon (DIN 1835 b) 16
	Gear ratio [i]:	1:1
	Torque max [Nm]:	50
	Rotation max [1/min]:	6000
	Rotating direction:	opposite
	Coolant:	EXT
	Please note:	Combi bearing
	Center distance [mm]:	65
8 030 45 599	Radial drilling and milling head ER 25 AX UT IC	
	Weight [kg]:	5.980
	Notation:	180° reversible
	Tool drive:	Flat (~DIN 1809)
	Shank size [mm]:	45.00
	Shank type:	BMT
	Tool adaption:	ER 25 A - u-tec
	Gear ratio [i]:	1:2
	Torque max [Nm]:	16
	Rotation max [1/min]:	12000
	Rotating direction:	same
	Coolant:	IC/Ext
	Pressure max [bar]:	140
	Please note:	stronger bearing
	Center distance [mm]:	77
8 030 46 196	Radial drilling and milling head HT 4	
	Notation:	180° reversible
	Tool drive:	Flat (~DIN 1809)
	Shank size [mm]:	45.00
	Shank type:	BMT
	Tool adaption:	HT 4
	Gear ratio [i]:	1:1
	Torque max [Nm]:	50
	Rotation max [1/min]:	6000
	Rotating direction:	opposite
	Coolant:	EXT
	Please note:	strong version
	Center distance [mm]:	65
8 030 46 197	Radial drilling and milling head HT 4 IC	
	Weight [kg]:	5.640
	Notation:	180° reversible
	Tool drive:	Flat (~DIN 1809)
	Shank size [mm]:	45.00
	Shank type:	BMT
	Tool adaption:	HT 4
	Gear ratio [i]:	1:1
	Torque max [Nm]:	50
	Rotation max [1/min]:	12000
	Rotating direction:	opposite
	Coolant:	IC/Ext
	Pressure max [bar]:	140

Part-#	Name	
	Center distance [mm]:	65
8 030 46 356	Angle-mill- and drill holder ER 32 AX UT IC	
	Notation:	180° reversible
	Tool drive:	Flat (~DIN 1809)
	Shank size [mm]:	45.00
	Shank type:	BMT
	Tool adaption:	ER 32 A - u-tec
	Gear ratio [i]:	1:1
	Torque max [Nm]:	50
	Rotation max [1/min]:	6000
	Rotating direction:	opposite
	Coolant:	IC/Ext
	Pressure max [bar]:	140
	Please note:	Combi bearing
	Center distance [mm]:	65
8 030 46 563	Radial drilling and milling head ER 32 AX UT IC	
	Weight [kg]:	5.480
	Notation:	180° reversible
	Tool drive:	Flat (~DIN 1809)
	Shank size [mm]:	45.00
	Shank type:	BMT
	Tool adaption:	ER 32 A - u-tec
	Gear ratio [i]:	1:1
	Torque max [Nm]:	50
	Rotation max [1/min]:	12000
	Rotating direction:	opposite
	Coolant:	IC/Ext
	Pressure max [bar]:	140
	Center distance [mm]:	65
8 030 46 564	Radial drilling and milling head ER 32 AX UT	
	Weight [kg]:	5.120
	Notation:	180° reversible
	Tool drive:	Flat (~DIN 1809)
	Shank size [mm]:	45.00
	Shank type:	BMT
	Tool adaption:	ER 32 A - u-tec
	Gear ratio [i]:	1:1
	Torque max [Nm]:	50
	Rotation max [1/min]:	12000
	Rotating direction:	opposite
	Coolant:	EXT
	Center distance [mm]:	65
8 030 47 122	Radial drilling and milling head Weldon 25 IC	
	Weight [kg]:	6.580
	Notation:	180° reversible
	Tool drive:	Flat (~DIN 1809)
	Shank size [mm]:	45.00
	Shank type:	BMT
	Tool adaption:	Weldon (DIN 1835 b) 25
	Gear ratio [i]:	2:1
	Torque max [Nm]:	63
	Rotation max [1/min]:	3000
	Rotating direction:	opposite

Part-#	Name	
	Coolant:	IC/Ext
	Pressure max [bar]:	140
	Please note:	Combi bearing
	Center distance [mm]:	65
8 031 45 026	Radial milling head universal arbor 22	
	Notation:	180° reversible
	Tool drive:	Flat (~DIN 1809)
	Shank size [mm]:	45.00
	Shank type:	BMT
	Tool adaption:	Universal arbor 22
	Gear ratio [i]:	2:1
	Torque max [Nm]:	63
	Rotation max [1/min]:	3000
	Rotating direction:	opposite
	Coolant:	EXT
	Please note:	Combi bearing
	Center distance [mm]:	65
8 031 45 054	Radial milling head universal arbor 1"	
	Weight [kg]:	6.040
	Notation:	180° reversible
	Tool drive:	Flat (~DIN 1809)
	Shank size [mm]:	45.00
	Shank type:	BMT
	Tool adaption:	Universal arbor 1" (25,4mm)
	Gear ratio [i]:	2:1
	Torque max [Nm]:	63
	Rotation max [1/min]:	3000
	Rotating direction:	opposite
	Coolant:	EXT
	Please note:	Combi bearing
	Center distance [mm]:	65
8 031 46 004	Radial milling head universal arbor 27	
	Notation:	180° reversible
	Tool drive:	Flat (~DIN 1809)
	Shank size [mm]:	45.00
	Shank type:	BMT
	Tool adaption:	Universal arbor 27
	Gear ratio [i]:	1:1
	Torque max [Nm]:	50
	Rotation max [1/min]:	6000
	Rotating direction:	opposite
	Coolant:	EXT
	Please note:	Combi bearing
	Center distance [mm]:	65
8 033 45 061	Radial drilling and milling head ER 25 AX UT	
	Weight [kg]:	5.500
	Notation:	offset; 180° reversible
	Tool drive:	Flat (~DIN 1809)
	Shank size [mm]:	45.00
	Shank type:	BMT
	Tool adaption:	ER 25 A - u-tec
	Gear ratio [i]:	3:1
	Torque max [Nm]:	32

Part-#	Name	
	Rotation max [1/min]:	3000
	Rotating direction:	same
	Coolant:	EXT
	Please note:	Combi bearing; check applicability!
	Center distance [mm]:	65
8 037 42 002	Radial disk mill head arbor 10	
	Weight [kg]:	4.600
	Notation:	180° reversible
	Version:	± 30° turnable
	Tool drive:	Flat (~DIN 1809)
	Shank size [mm]:	45.00
	Shank type:	BMT
	Tool adaption:	Arbor 10
	Gear ratio [i]:	2:1
	Torque max [Nm]:	32
	Rotation max [1/min]:	4000
	Rotating direction:	opposite
	Coolant:	EXT
	Center distance [mm]:	78
8 037 43 004	Radial disk mill head arbor 13	
	Weight [kg]:	4.630
	Notation:	180° reversible
	Version:	± 30° turnable
	Tool drive:	Flat (~DIN 1809)
	Shank size [mm]:	45.00
	Shank type:	BMT
	Tool adaption:	Arbor 13
	Gear ratio [i]:	2:1
	Torque max [Nm]:	32
	Rotation max [1/min]:	4000
	Rotating direction:	opposite
	Coolant:	EXT
	Center distance [mm]:	78
8 039 45 076	Radial drilling and milling head ER 25 AX UT	
	Weight [kg]:	5.900
	Notation:	180° reversible
	Version:	double spindle
	Tool drive:	Flat (~DIN 1809)
	Shank size [mm]:	45.00
	Shank type:	BMT
	Tool adaption:	ER 25 A - u-tec
	Gear ratio [i]:	1:1
	Torque max [Nm]:	50
	Rotation max [1/min]:	12000
	Rotating direction:	same/opposite
	Coolant:	EXT
	Center distance [mm]:	65



Part-#	Name	
	8 039 45 106	Radial drilling and milling head ER 25 AX UT
	Weight [kg]:	6.250
	Notation:	180° reversible
	Employment for:	Main- and sub spindle
	Version:	double spindle
	Tool drive:	Flat (~DIN 1809)
	Shank size [mm]:	45.00
	Shank type:	BMT
	Tool adaption:	ER 25 A - u-tec
	Gear ratio [i]:	1:1
	Torque max [Nm]:	25/Sp.
	Rotation max [1/min]:	12000
	Rotating direction:	same
Coolant:	EXT	
Center distance [mm]:	50/86	
	8 039 46 031	Radial drilling and milling head HT 4
	Weight [kg]:	6.400
	Notation:	180° reversible
	Employment for:	Main- and sub spindle
	Version:	double spindle
	Tool drive:	Flat (~DIN 1809)
	Shank size [mm]:	45.00
	Tool adaption:	HT 4
	Gear ratio [i]:	1:1
	Torque max [Nm]:	50
	Rotation max [1/min]:	12000
	Rotating direction:	same/opposite
	Coolant:	EXT
Center distance [mm]:	65	
	8 040 44 019	Universal head ± 90° adjustable ER 16
	Weight [kg]:	2.460
	Tool drive:	Flat (~DIN 1809)
	Shank size [mm]:	45.00
	Shank type:	BMT
	Tool adaption:	ER 16
	Gear ratio [i]:	1:1
	Torque max [Nm]:	10
	Rotation max [1/min]:	6000
	Rotating direction:	same
	Coolant:	EXT
	Please note:	Note swivel range!
	Center distance [mm]:	55
	8 040 44 021	Universal head ± 90° adjustable ER 16
	Weight [kg]:	2.700
	Notation:	180° reversible
	Tool drive:	Flat (~DIN 1809)
	Shank size [mm]:	45.00
	Shank type:	BMT
	Tool adaption:	ER 16
	Gear ratio [i]:	1:1
	Torque max [Nm]:	10
	Rotation max [1/min]:	6000
	Rotating direction:	same
	Coolant:	EXT

Part-#	Name
--------	------

Please note: position can be pinned; note swivel range!
Center distance [mm]: 55

8 040 44 023 Universal head ± 90° adjustable ER 20

Weight [kg]: 2.800
Tool drive: Flat (~DIN 1809)
Shank size [mm]: 45.00
Shank type: BMT
Tool adaption: ER 20
Gear ratio [i]: 1:1
Torque max [Nm]: 10
Rotation max [1/min]: 6000
Rotating direction: same
Coolant: EXT
Please note: Note swivel range!
Center distance [mm]: 55

8 040 44 104 Universal head ± 90° adjustable ER 16

Notation: 180° reversible
Version: 45° position can be pinned
Tool drive: Flat (~DIN 1809)
Shank size [mm]: 45.00
Shank type: BMT
Tool adaption: ER 16
Gear ratio [i]: 1:1
Torque max [Nm]: 10
Rotation max [1/min]: 6000
Rotating direction: same
Coolant: EXT
Center distance [mm]: 55

8 043 44 004 Universal head +105°/-20° adj. ER16AX UTIK

Weight [kg]: 5.450
Notation: offset
Tool drive: Flat (~DIN 1809)
Shank size [mm]: 45.00
Shank type: BMT
Tool adaption: ER 16 A - u-tec
Gear ratio [i]: 1:1
Torque max [Nm]: 25
Rotation max [1/min]: 6000
Rotating direction: opposite
Coolant: IC/Ext
Pressure max [bar]: 25
Please note: 180° reversible
Center distance [mm]: 50
Offset [mm]: 35

8 043 44 005 Universal head +105°/-20° adj. ER16 AX UT



Weight [kg]: 5.360
Notation: offset; 180° reversible
Tool drive: Flat (~DIN 1809)
Shank size [mm]: 45.00
Shank type: BMT
Tool adaption: ER 16 A - u-tec
Gear ratio [i]: 1:1
Torque max [Nm]: 25

Part-#	Name
--------	------

Rotation max [1/min]: 6000
 Rotating direction: opposite
 Coolant: EXT
 Center distance [mm]: 50
 Offset [mm]: 35

8 043 44 006 Universal head +105°/-20° adj. ER16AX UTIK



Weight [kg]: 5.470
 Notation: offset
 Tool drive: Flat (~DIN 1809)
 Shank size [mm]: 45.00
 Shank type: BMT
 Tool adaption: ER 16 A - u-tec
 Gear ratio [i]: 1:2
 Torque max [Nm]: 12
 Rotation max [1/min]: 12000
 Rotating direction: opposite
 Coolant: IC/Ext
 Pressure max [bar]: 25
 Please note: 180° reversible
 Center distance [mm]: 50
 Offset [mm]: 35

8 043 44 007 Universal head +105°/-20° adj. ER16 AX UT

Weight [kg]: 5.410
 Notation: offset
 Tool drive: Flat (~DIN 1809)
 Shank size [mm]: 45.00
 Shank type: BMT
 Tool adaption: ER 16 A - u-tec
 Gear ratio [i]: 1:2
 Torque max [Nm]: 12
 Rotation max [1/min]: 12000
 Rotating direction: opposite
 Coolant: EXT
 Please note: 180° reversible
 Center distance [mm]: 50
 Offset [mm]: 35

8 043 44 042 Universal head +105°/-20° adj. ER16AX UTIK

Weight [kg]: 5.470
 Notation: offset
 Version: at 71,5° position can be pinned
 Tool drive: Flat (~DIN 1809)
 Shank size [mm]: 45.00
 Shank type: BMT
 Tool adaption: ER 16 A - u-tec
 Gear ratio [i]: 1:1
 Torque max [Nm]: 25
 Rotation max [1/min]: 6000
 Rotating direction: opposite
 Coolant: IC/Ext
 Pressure max [bar]: 25
 Please note: 180° reversible
 Center distance [mm]: 50

Part-#	Name
--------	------

8 043 45 000



Universal head +105°/-20° adj. ER25 AX UT

Weight [kg]: 5.580
 Notation: offset; 180° reversible
 Tool drive: Flat (~DIN 1809)
 Shank size [mm]: 45.00
 Shank type: BMT
 Tool adaption: ER 25 A - u-tec
 Gear ratio [i]: 1:1
 Torque max [Nm]: 25
 Rotation max [1/min]: 6000
 Rotating direction: opposite
 Coolant: EXT
 Please note: stronger bearing
 Center distance [mm]: 50

8 043 45 004



Universal head +105°/-20° adj. ER25AX UTIK

Weight [kg]: 5.660
 Notation: offset; 180° reversible
 Tool drive: Flat (~DIN 1809)
 Shank size [mm]: 45.00
 Shank type: BMT
 Tool adaption: ER 25 A - u-tec
 Gear ratio [i]: 1:1
 Torque max [Nm]: 25
 Rotation max [1/min]: 6000
 Rotating direction: opposite
 Coolant: IC/Ext
 Pressure max [bar]: 25
 Please note: stronger bearing
 Center distance [mm]: 50
 Offset [mm]: 35

8 043 45 005

Universal head +105°/-20° adj. ER25AX UTIK

Weight [kg]: 5.610
 Notation: offset; 180° reversible
 Version: at 42,9° position can be pinned
 Tool drive: Flat (~DIN 1809)
 Shank size [mm]: 45.00
 Shank type: BMT
 Tool adaption: ER 25 A - u-tec
 Gear ratio [i]: 1:1
 Torque max [Nm]: 25
 Rotation max [1/min]: 6000
 Rotating direction: opposite
 Coolant: IC/Ext
 Pressure max [bar]: 25
 Please note: stronger bearing
 Center distance [mm]: 50
 Offset [mm]: 35

8 043 45 015

Universal head +105°/-20° adj. Weldon 16



Notation: offset; 180° reversible
 Tool drive: Flat (~DIN 1809)
 Shank size [mm]: 45.00
 Shank type: BMT
 Tool adaption: Weldon (DIN 1835 b) 16 special
 Gear ratio [i]: 1:1

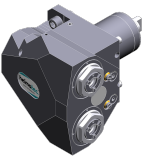

Part-#	Name	
	Torque max [Nm]:	25
	Rotation max [1/min]:	6000
	Rotating direction:	opposite
	Coolant:	EXT
	Please note:	stronger bearing
	Center distance [mm]:	50
	Offset [mm]:	35
8 043 45 017	Universal head +105°/-20° adj. ER25 AX UT	
	Weight [kg]:	5.590
	Notation:	offset; 180° reversible; at 45° position can be pinned
	Tool drive:	Flat (~DIN 1809)
	Shank size [mm]:	45.00
	Shank type:	BMT
	Tool adaption:	ER 25 A - u-tec
	Gear ratio [i]:	1:1
	Torque max [Nm]:	25
	Rotation max [1/min]:	6000
	Rotating direction:	opposite
	Coolant:	EXT
	Please note:	stronger bearing
	Center distance [mm]:	50
8 043 46 002	Universal head +105°/-20° adj. Weldon 20	
	Weight [kg]:	5.790
	Notation:	offset; 180° reversible
	Tool drive:	Flat (~DIN 1809)
	Shank size [mm]:	45.00
	Shank type:	BMT
	Tool adaption:	Weldon (DIN 1835 b) 20
	Gear ratio [i]:	1:1
	Torque max [Nm]:	25
	Rotation max [1/min]:	6000
	Rotating direction:	opposite
	Coolant:	EXT
	Please note:	stronger bearing
	Center distance [mm]:	50
	Offset [mm]:	35
8 050 43 009	Multispindle drilling head ER 11	
	Tool drive:	Flat (~DIN 1809)
	Shank size [mm]:	45.00
	Shank type:	BMT
	Tool adaption:	ER 11
	Gear ratio [i]:	1:1
	Torque max [Nm]:	10/Sp.
	Rotation max [1/min]:	6000
	Rotating direction:	opposite
	Coolant:	EXT
8 050 44 005	Multispindle drilling head ER 16 AX UT	
	Weight [kg]:	3.700
	Version:	2-spindles
	Tool drive:	Flat (~DIN 1809)
	Shank size [mm]:	45.00
	Tool adaption:	ER 16 A - u-tec
	Gear ratio [i]:	1:1



Part-#	Name	
	Torque max [Nm]:	25/Sp.
	Rotation max [1/min]:	12000
	Rotating direction:	opposite
	Coolant:	EXT
8 050 44 045	Multispindle drilling head ER 16 AX UT	
	Weight [kg]:	5.840
	Notation:	offset, 180° reversible
	Version:	2-spindles
	Tool drive:	Flat (~DIN 1809)
	Shank size [mm]:	45.00
	Shank type:	BMT
	Tool adaption:	ER 16 A - u-tec
	Gear ratio [i]:	1:2
	Torque max [Nm]:	8/Sp.
	Rotation max [1/min]:	12000
	Rotating direction:	same
	Coolant:	EXT
	Offset [mm]:	64,359
8 053 44 032	Multispindle radial head ER 16 AX UT	
	Weight [kg]:	6.120
	Notation:	180° reversible
	Version:	2-spindles
	Tool drive:	Flat (~DIN 1809)
	Shank size [mm]:	45.00
	Shank type:	BMT
	Tool adaption:	ER 16 A - u-tec
	Gear ratio [i]:	1:2
	Torque max [Nm]:	8
	Rotation max [1/min]:	12000
	Rotating direction:	same
	Coolant:	EXT
	Center distance [mm]:	65
8 053 44 062	Multispindle radial head ER16 AX UT IC	
	Weight [kg]:	6.580
	Notation:	180° reversible
	Version:	2-spindles
	Tool drive:	Flat (~DIN 1809)
	Shank size [mm]:	45.00
	Shank type:	BMT
	Tool adaption:	ER 16 A - u-tec
	Gear ratio [i]:	1:1
	Torque max [Nm]:	32/Sp
	Rotation max [1/min]:	12000
	Rotating direction:	same
	Coolant:	IC/Ext
	Pressure max [bar]:	140
	Center distance [mm]:	65

Part-#	Name	
8 053 44 063	Multispindle radial head ER16 AX UT IC	
		<p>Notation: 180° reversible Version: 2-spindles Tool drive: Flat (~DIN 1809) Shank size [mm]: 45.00 Shank type: BMT Tool adaption: ER 16 A - u-tec Gear ratio [i]: 1:2 Torque max [Nm]: 16/Sp Rotation max [1/min]: 12000 Rotating direction: same Coolant: IC/Ext Pressure max [bar]: 140 Center distance [mm]: 65</p>
8 053 44 065	Multispindle radial head ER 16 AX UT	
		<p>Weight [kg]: 6.400 Notation: 180° reversible Version: 2-spindles Tool drive: Flat (~DIN 1809) Shank size [mm]: 45.00 Shank type: BMT Tool adaption: ER 16 A - u-tec Gear ratio [i]: 1:2 Torque max [Nm]: 16/Sp Rotation max [1/min]: 12000 Rotating direction: same Coolant: EXT Center distance [mm]: 65</p>
8 053 44 066	Multispindle radial head ER 16 AX UT	
		<p>Notation: 180° reversible Version: 2-spindles Tool drive: Flat (~DIN 1809) Shank size [mm]: 45.00 Shank type: BMT Tool adaption: ER 16 A - u-tec Gear ratio [i]: 1:1 Torque max [Nm]: 32/Sp Rotation max [1/min]: 12000 Rotating direction: same Coolant: EXT Center distance [mm]: 65</p>
8 053 44 067	Multispindle radial head ER 20 AX UT	
		<p>Notation: 180° reversible Version: 2-spindles Tool drive: Flat (~DIN 1809) Shank size [mm]: 45.00 Shank type: BMT Tool adaption: ER 20 A - u-tec Gear ratio [i]: 1:1 Torque max [Nm]: 32/Sp Rotation max [1/min]: 12000 Rotating direction: same Coolant: EXT Please note: Check applicability; note tool length!</p>

Part-#	Name	
	Center distance [mm]:	75
8 053 44 074	Multispindle radial head ER 20 AX UTIK	
	Notation:	180° reversible
	Version:	2-spindles
	Tool drive:	Flat (~DIN 1809)
	Shank size [mm]:	45.00
	Shank type:	BMT
	Tool adaption:	ER 20 A - u-tec
	Gear ratio [i]:	1:1
	Torque max [Nm]:	32/Sp
	Rotation max [1/min]:	12000
	Rotating direction:	same
	Coolant:	IC/Ext
	Pressure max [bar]:	140
	Please note:	Check applicability; note tool length!
	Center distance [mm]:	75
8 200 02 001	Cover plate	
	Weight [kg]:	0.320
	Shank type:	-
8 202 00 010	Basic holder longitudinal seat FN 12	
	Weight [kg]:	0.920
	Notation:	180° reversible
	Shank type:	BMT
	Machine adaption:	Centering bolt ø 12
	Tool adaption:	Interface FN 12
	Coolant:	EXT
8 224 01 020	Cut-off holder sq. 20	
	Weight [kg]:	2.020
	Employment for:	right cutting tools
	Version:	Special; edge on side of turret
	Shank type:	BMT
	Machine adaption:	Centering bolt ø 12
	Tool adaption:	Sq. 20
	Coolant:	EXT
8 224 03 016	Universal turning holder sq. 3/4" IC	
	Weight [kg]:	2.630
	Notation:	180° reversible
	Shank type:	BMT
	Machine adaption:	Centering bolt ø 12
	Tool adaption:	Sq. 3/4" (19,05mm)
		Sq. 3/4" (19,05mm)
	Coolant:	IC/Ext
	Pressure max [bar]:	100
	Please note:	Key rail

Part-#	Name	
8 224 04 000	Universal turning holder sq. 20	
	Weight [kg]:	2.640
	Notation:	180° reversible
	Shank type:	BMT
	Machine adaption:	Centering bolt ø 12
	Tool adaption:	Sq. 20
		Sq. 20
	Coolant:	EXT
8 224 04 035	Universal turning holder sq. 20 IC	
	Weight [kg]:	2.620
	Notation:	180° reversible
	Shank type:	BMT
	Machine adaption:	Centering bolt ø 12
	Tool adaption:	Sq. 20
	Coolant:	IC
8 224 04 068	Universal turning holder sq. 20 IC	
	Weight [kg]:	2.610
	Notation:	180° reversible
	Shank type:	BMT
	Machine adaption:	Centering bolt ø 12
	Tool adaption:	Sq. 20
		Sq. 20
	Coolant:	IC/Ext
	Pressure max [bar]:	100
	Please note:	Key rail
8 229 05 004	Tool holder C 3 IC	
	Weight [kg]:	2.980
	Notation:	180° reversible
	Version:	right
	Shank type:	BMT
	Machine adaption:	Centering bolt ø 12
	Tool adaption:	heimatec Capto(TM) C 3
	Coolant:	IC
	Please note:	Check applicability; note tool length!
	Offset [mm]:	65
8 229 05 005	Tool holder C 3 IC	
	Weight [kg]:	1.590
	Notation:	180° reversible
	Version:	right
	Shank type:	BMT
	Machine adaption:	Centering bolt ø 12
	Tool adaption:	heimatec Capto(TM) C 3
	Coolant:	IC
	Please note:	Check applicability; note tool length!
	Offset [mm]:	27

Part-#	Name	
8 240 05 034	Boring bar holder Ø 16	
	Weight [kg]:	4.360
	Notation:	180° reversible
	Shank type:	BMT
	Machine adaption:	Centering bolt ø 12
	Tool adaption:	Ø 16
	Coolant:	IC/Ext
	Center distance [mm]:	75
8 240 05 059	Tool holder C 3 IC	
	Weight [kg]:	4.130
	Notation:	180° reversible
	Version:	right
	Shank type:	BMT
	Machine adaption:	Centering bolt ø 12
	Tool adaption:	heimatec Capto(TM) C 3
	Coolant:	IC
	Please note:	Check applicability; note tool length!
	Center distance [mm]:	80
8 240 05 060	Tool holder C 3 IC	
	Weight [kg]:	3.190
	Notation:	180° reversible
	Version:	offset; right
	Shank type:	BMT
	Machine adaption:	Centering bolt ø 12
	Tool adaption:	heimatec Capto(TM) C 3
	Coolant:	IC
	Please note:	Check applicability; note tool length!
	Center distance [mm]:	80
8 240 06 034	Boring bar holder Ø 20	
	Weight [kg]:	4.280
	Notation:	180° reversible
	Shank type:	BMT
	Machine adaption:	Centering bolt ø 12
	Tool adaption:	Ø 20
	Coolant:	IC/Ext
	Center distance [mm]:	75
8 240 07 038	Boring bar holder Ø 25	
	Weight [kg]:	4.160
	Notation:	180° reversible
	Shank type:	BMT
	Machine adaption:	Centering bolt ø 12
	Tool adaption:	Ø 25
	Coolant:	IC/Ext
	Center distance [mm]:	75
8 240 07 050	Boring bar holder Ø 1 1/4 "	
	Weight [kg]:	3.790
	Notation:	offset
	Shank type:	BMT
	Machine adaption:	Centering bolt ø 12
	Tool adaption:	Ø 1 1/4" (31,75mm)
	Coolant:	IC/Ext
	Center distance [mm]:	75

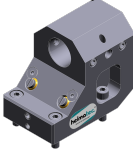
Part-#	Name	
8 240 08 000	Boring bar holder Ø 32 	Weight [kg]: 3.740
		Notation: offset
		Shank type: BMT
		Machine adaption: Centering bolt ø 12
		Tool adaption: Ø 32
		Coolant: IC/Ext
		Center distance [mm]: 75
8 240 08 046	Boring bar holder Ø 32	Weight [kg]: 3.940
		Notation: 180° reversible
		Shank type: BMT
		Machine adaption: Centering bolt ø 12
		Tool adaption: Ø 32
		Coolant: IC/Ext
		Center distance [mm]: 75
8 240 08 074	Boring bar holder Ø 1 1/2"	Weight [kg]: 4.000
		Shank type: BMT
		Machine adaption: Centering bolt ø 12
		Tool adaption: Ø 1 1/2" (38,1mm)
		Coolant: IC/Ext
		Center distance [mm]: 75
8 240 09 002	Boring bar holder Ø 40 	Weight [kg]: 2.660
		Version: offset
		Shank type: BMT
		Machine adaption: Centering bolt Ø 12
		Tool adaption: Ø 40
		Coolant: IC/Ext
		Center distance [mm]: 75
8 240 09 013	Boring bar holder Ø 40	Weight [kg]: 3.950
		Shank type: BMT
		Machine adaption: Centering bolt Ø 12
		Tool adaption: Ø 40
		Coolant: IC/Ext
		Center distance [mm]: 75
8 244 04 019	Combi facing holder sq. 20	Weight [kg]: 3.700
		Shank type: BMT
		Machine adaption: Centering bolt ø 12
		Tool adaption: Sq. 20
		Coolant: EXT
8 249 05 008	Double tool holder C 3 IC	Weight [kg]: 4.860
		Employment for: Main- and sub spindle
		Version: right
		Shank type: BMT
		Machine adaption: Centering bolt ø 12
		Tool adaption: heimatec Capto(TM) C 3

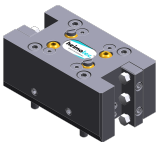
Part-#	Name	
		heimatec Capto(TM) C 3 IC Check applicability; note tool length! 80
8 250 05 002	Multiple tool holder C 3 IC	
	Coolant:	
	Please note:	
	Center distance [mm]:	
	Weight [kg]:	2.140
	Employment for:	Main- and sub spindle
	Version:	right
	Shank type:	BMT
	Machine adaption:	Centering bolt ø 12
	Tool adaption:	heimatec Capto(TM) C 3 heimatec Capto(TM) C 3
	Coolant:	IC
	Please note:	Check applicability; note tool length!
	Offset [mm]:	27 27
8 250 05 003	Multiple tool holder C 3 IC	
	Weight [kg]:	3.730
	Employment for:	Main- and sub spindle
	Version:	right
	Shank type:	BMT
	Machine adaption:	Centering bolt ø 12
	Tool adaption:	heimatec Capto(TM) C 3 heimatec Capto(TM) C 3
	Coolant:	IC
	Please note:	Check applicability; note tool length!
	Offset [mm]:	65 65
8 251 03 002	Combi double turning holder sq. 3/4"IC	
	Weight [kg]:	4.360
	Notation:	180° reversible
	Shank type:	BMT
	Machine adaption:	Centering bolt ø 12
	Tool adaption:	Sq. 3/4" (19,05mm) Sq. 3/4" (19,05mm) Sq. 3/4" (19,05mm) Sq. 3/4" (19,05mm)
	Coolant:	IC/Ext
	Pressure max [bar]:	100
	Please note:	Key rail
8 251 04 002	Combi double turning holder sq. 20	
	Weight [kg]:	4.380
	Notation:	180° reversible
	Shank type:	BMT
	Machine adaption:	Centering bolt ø 12
	Tool adaption:	Sq. 20 Sq. 20 Sq. 20 Sq. 20
	Coolant:	EXT

Part-#	Name	
8 251 04 003	Combi double turning holder sq. 3/4"	
	Weight [kg]:	4.410
	Notation:	180° reversible
	Shank type:	BMT
	Machine adaption:	Centering bolt \varnothing 12
	Tool adaption:	Sq. 3/4" (19,05mm)
		Sq. 3/4" (19,05mm)
		Sq. 3/4" (19,05mm)
		Sq. 3/4" (19,05mm)
	Coolant:	EXT
8 251 04 059	Combi double turning holder sq. 20 IC	
	Weight [kg]:	4.360
	Notation:	180° reversible
	Shank type:	BMT
	Machine adaption:	Centering bolt \varnothing 12
	Tool adaption:	Sq. 20
		Sq. 20
		Sq. 20
		Sq. 20
	Coolant:	IC/Ext
	Pressure max [bar]:	100
	Please note:	Key rail
8 253 07 000	Double boring bar holder \varnothing 25	
	Weight [kg]:	2.320
	Notation:	offset, 180° reversible
	Shank type:	BMT
	Machine adaption:	Centering bolt \varnothing 12
	Tool adaption:	\varnothing 25
		\varnothing 25
	Coolant:	IC/Ext
	Center distance [mm]:	50/85
8 253 07 003	Multiple boring bar holder \varnothing 1"	
	Weight [kg]:	2.530
	Notation:	offset, 180° reversible
	Shank type:	BMT
	Machine adaption:	Centering bolt \varnothing 12
	Tool adaption:	\varnothing 1" (25,4mm)
		\varnothing 1" (25,4mm)
	Coolant:	IC/Ext
	Center distance [mm]:	50/85
8 253 07 004	Double boring bar holder \varnothing 1"	
	Weight [kg]:	3.740
	Notation:	180° reversible
	Shank type:	BMT
	Machine adaption:	Centering bolt \varnothing 12
	Tool adaption:	\varnothing 1" (25,4mm)
		\varnothing 1" (25,4mm)
	Coolant:	IC/Ext
	Center distance [mm]:	50/85

Part-#	Name	
8 253 07 006	Double boring bar holder Ø 25	
		<p>Weight [kg]: 3.710 Notation: 180° reversible Shank type: BMT Machine adaption: Centering bolt Ø 12 Tool adaption: Ø 25 Ø 25 Coolant: IC/Ext Center distance [mm]: 50/85</p>
8 259 01 006	Multiple turning holder 4x sq. 20	<p>Weight [kg]: 4.700 Employment for: Main- and sub spindle Version: Y-axes offset Shank type: BMT Machine adaption: Centering bolt ø 12 Tool adaption: Sq. 20 Sq. 20 Sq. 20 Sq. 20 Coolant: EXT</p>
		<p>Weight [kg]: 5.590 Employment for: Main- and sub spindle Version: right; Y-axes offset Shank type: BMT Machine adaption: Centering bolt ø 12 Tool adaption: heimatec Capto(TM) C 3 heimatec Capto(TM) C 3 heimatec Capto(TM) C 3 heimatec Capto(TM) C 3 Coolant: IC Please note: Check applicability; note tool length! not Offset [mm]: 65 65</p>
8 259 05 001	Multiple tool holder C 3 IC	<p>Weight [kg]: 6.330 Employment for: Main- and sub spindle Version: right; Y-axes offset Shank type: BMT Machine adaption: Centering bolt ø 12 Tool adaption: heimatec Capto(TM) C 3 heimatec Capto(TM) C 3 heimatec Capto(TM) C 3 heimatec Capto(TM) C 3 Coolant: IC Please note: Check applicability; note tool length! Center distance [mm]: 80</p>
		<p>Weight [kg]: 6.330 Employment for: Main- and sub spindle Version: right; Y-axes offset Shank type: BMT Machine adaption: Centering bolt ø 12 Tool adaption: heimatec Capto(TM) C 3 heimatec Capto(TM) C 3 heimatec Capto(TM) C 3 heimatec Capto(TM) C 3 Coolant: IC Please note: Check applicability; note tool length! Center distance [mm]: 80</p>

Part-#	Name	
8 259 05 003	Multiple tool holder C 3 IC	
	Notation:	180° reversible
	Version:	right; Y-axes offset
	Shank type:	BMT
	Machine adaption:	Centering bolt ø 12
	Tool adaption:	heimatec Capto(TM) C 3 heimatec Capto(TM) C 3
	Coolant:	IC
	Please note:	Check applicability; note tool length!
	Center distance [mm]:	80
	Offset [mm]:	+32 -32
8 259 05 004	Multiple tool holder C 3 IC	
	Weight [kg]:	4.390
	Notation:	180° reversible
	Version:	right; offset; Y-axes offset
	Shank type:	BMT
	Machine adaption:	Centering bolt ø 12
	Tool adaption:	heimatec Capto(TM) C 3 heimatec Capto(TM) C 3
	Coolant:	IC
	Please note:	Check applicability; note tool length!
	Center distance [mm]:	80
8 259 05 005	Multiple tool holder C 3 IC	
	Weight [kg]:	4.210
	Employment for:	Main- and sub spindle
	Version:	right; Y-axes offset
	Shank type:	BMT
	Machine adaption:	Centering bolt ø 12
	Tool adaption:	heimatec Capto(TM) C 3 heimatec Capto(TM) C 3 heimatec Capto(TM) C 3 heimatec Capto(TM) C 3
	Coolant:	IC
	Please note:	Check applicability; note tool length!; not
	Offset [mm]:	27 27
8 259 05 006	Multiple tool holder C 3 IC	
	Weight [kg]:	2.840
	Notation:	180° reversible
	Version:	right; Y-axes offset
	Shank type:	BMT
	Machine adaption:	Centering bolt ø 12
	Tool adaption:	heimatec Capto(TM) C 3 heimatec Capto(TM) C 3
	Coolant:	IC
	Please note:	Check applicability; note tool length!
	Offset [mm]:	27

Part-#	Name	
8 259 05 007	Multiple tool holder C 3 IC	
		<p>Weight [kg]: 4.000 Notation: 180° reversible Version: right; Y-axes offset Shank type: BMT Machine adaption: Centering bolt ø 12 Tool adaption: heimatec Capto(TM) C 3 heimatec Capto(TM) C 3 Coolant: IC Pressure max [bar]: 100 Please note: Check applicability; note tool length! Offset [mm]: 65</p>
8 259 09 001	Multiple holder ø25 and sq. 20	<p>Weight [kg]: 3.980 Notation: 180° reversible Shank type: BMT Machine adaption: Centering bolt ø 12 Tool adaption: ø25/ sq. 20 ø25/ sq. 20 Coolant: IC/Ext Center distance [mm]: 50/85</p>
8 261 08 000	Tool holder for centering insert	<p>Weight [kg]: 5.270 Notation: 180° reversible Shank type: BMT Machine adaption: Centering bolt ø 12 Tool adaption: ø 32 Coolant: EXT Please note: Price without centering point Center distance [mm]: 55</p>
8 263 09 000	Tool holder with rotating centering point	<p>Weight [kg]: 4.070 Notation: 180° reversible Shank type: BMT Machine adaption: Centering bolt ø 12 Rotation max [1/min]: 6000 Coolant: EXT Please note: Taper roller bearings Center distance [mm]: 75</p>
8 263 09 007	Tool holder with rotating centering point	<p>Weight [kg]: 6.410 Notation: 180° reversible; offset Shank type: BMT Machine adaption: Centering bolt ø 12 Rotation max [1/min]: 6000 Coolant: EXT Center distance [mm]: 85</p>

Part-#	Name	
8 320 02 017	Cut-off holder, height adjustable SH 26 IC	
	Weight [kg]:	1.410
	Notation:	180° reversible
	Shank type:	BMT
	Machine adaption:	Centering bolt ø 12
	Tool adaption:	Clampshaft SH 26
	Coolant:	IC/Ext
	Pressure max [bar]:	70
8 320 02 018	Cut-off holder, height adjustable SH 26 IC	
	Weight [kg]:	1.560
	Notation:	180° reversible
	Shank type:	BMT
	Machine adaption:	Centering bolt ø 12
	Tool adaption:	Clampshaft SH 26
	Coolant:	IC/Ext
	Pressure max [bar]:	70
	Please note:	Clampshaft internal
8 320 09 003	Cut-off holder, height adjustable 845 IC	
	Weight [kg]:	1.390
	Notation:	180° reversible
	Shank type:	BMT
	Machine adaption:	Centering bolt ø 12
	Tool adaption:	 System 845
	Coolant:	IC
	Pressure max [bar]:	70

heimatec.u-tec®

heimatec.com

Products / Tool change systems /
u-tec® Tool-changing system



versions see catalog



heimatec.easy-quick

heimatec.com

Products / Tool change systems /
easy-quick HT quick-changing system



versions see catalog

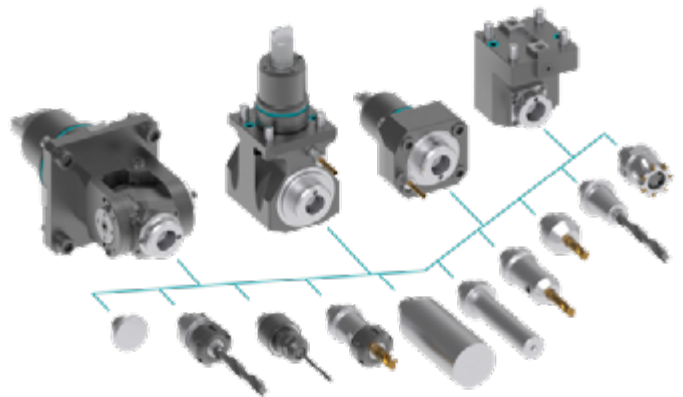

heimatec.Capto™

heimatec.com

Products / Tool change systems /
heimatec.Capto™ quick-changing system



versions see catalog

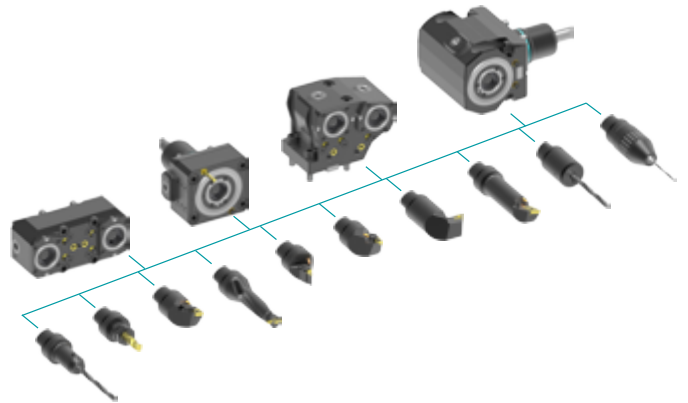

heimatec.accessories

heimatec.com

Products / Accessories



versions see catalog





● heimatec overseas branches

○ global representations of heimatec

heimatec[®]

heimatec GmbH
Präzisionswerkzeuge
Carl-Benz-Str. 4
77871 Renchen
Germany

T +49 7843 9466 0
www.heimatec.com
info@heimatec.com

Please find the contact details of our worldwide trading partners on our website:
<https://heimatec.com/business-partners>