

Werkzeugkatalog

tool catalogue

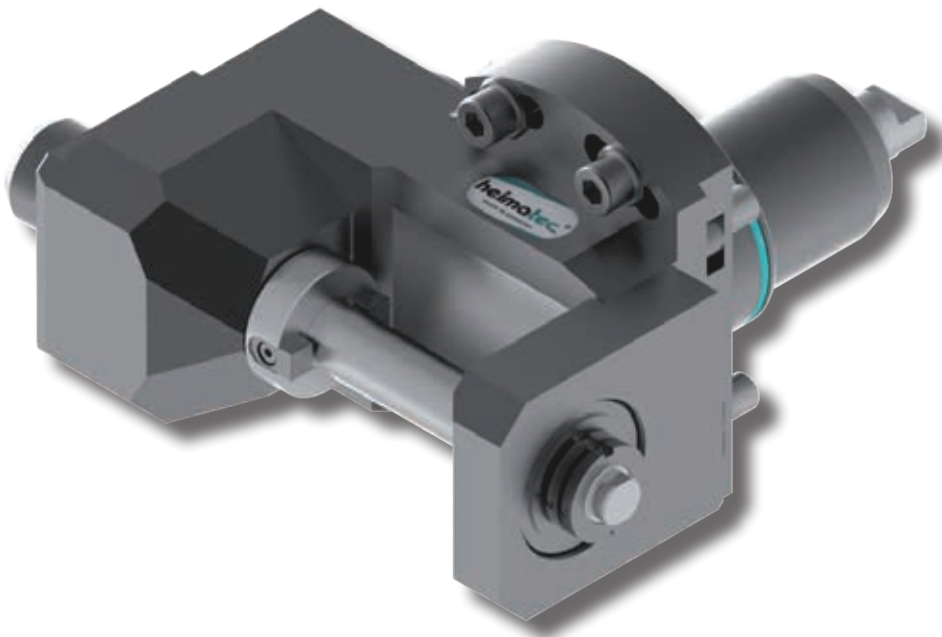

Nakamura

Super NTX

100er Revolver (65) / 100 turret (65)



Das Katalog-Werk einschließlich aller seiner Teile ist urheberrechtlich geschützt. Jede Verwertung außerhalb der engen Grenzen des Urheberrechtsgesetzes ist ohne Zustimmung der Rechteinhaber unzulässig und strafbar. Das gilt insbesondere für Vervielfältigungen, Übersetzungen, Mikroverfilmungen und die Einspeicherung und Verarbeitung in elektronischen Systemen.

heimatec® GmbH behält sich Änderungen technischer Art jederzeit ohne Vorankündigung vor. Dies gilt insbesondere bei Anpassungen an neue oder geänderte internationale Normen oder bei Weiterentwicklungen unserer Produkte oder Herstellungsprozesse.

This catalogue, including all its parts, is protected by copyright. Each use outside the restricted limitations of the Copyright Act is inadmissible and liable to prosecution without the consent of heimatec. This is particularly valid for duplication, translation, microfilming and feeding and processing in electronic systems.

heimatec® GmbH reserves the right of technical changes everytime without advance notice, which is particularly valid for adaptations to new or changed international standards, or to developments of our products or manufacturing processes.

Hinweis zu den AGBs:
Diese finden Sie in unserem Internetauftritt unter
heimatec.de
Home/Impressum/AGB

Terms and conditions:
You will find them on our website
heimatec.com
Home/Imprint/Terms and Conditions



angetriebene Werkzeuge

driven tools



Axial-Bohr- und Fräskopf

axial drilling and milling head

$n_{max} = 6000 \text{ min}^{-1}$

8 010 66 126	ER 32 A u-tec	EK	1:1
8 010 66 127	ER 32 A u-tec	IK 70 bar	1:1



Axial-Bohr- und Fräskopf

axial drilling and milling head

$n_{max} = 5000 \text{ min}^{-1}$

8 010 66 050	ER 32 A u-tec	EK	1:1
8 010 66 066	ER 32 A u-tec	IK 25 bar	1:1
8 010 66 067	ER 32 A u-tec	IK 70 bar	1:1
8 010 67 013	<i>easy quick</i> HT 5	EK	1:1
8 010 67 016	<i>easy quick</i> HT 5	IK 25 bar	1:1
8 010 67 029	<i>easy quick</i> HT 5	IK 70 bar	1:1

$n_{max} = 6000 \text{ min}^{-1}$



Axial-Bohr- und Fräskopf

axial drilling and milling head

$n_{max} = 24000 \text{ min}^{-1}$

8 013 64 002	ER 16 A u-tec	EK	1:4
8 013 64 004	ER 16 A u-tec	IK 70 bar	1:4



Axial-Bohr- und Fräskopf

axial drilling and milling head

$n_{max} = 5000 \text{ min}^{-1}$

8 011 65 013	Kombidorn/universal arbor 22	EK	1:1
8 011 66 009	Kombidorn/universal arbor 27	EK	1:1
8 011 64 006	Kombidorn/universal arbor 3/4"	EK	1:1



Axial-Bohr- und Fräskopf

axial drilling and milling head

Achsversatz / offset A=50

8 019 65 001	ER 25 A u-tec	EK	1:1
8 019 65 011	ER 25 A u-tec	IK 140 bar	1:1
$n_{max} = 6000 \text{ min}^{-1}$			
8 019 65 010	ER 25 A u-tec	EK	1:2
8 019 65 007	ER 25 A u-tec	IK 140 bar	1:2
$n_{max} = 12000 \text{ min}^{-1}$			
8 019 65 006	ER 25 A u-tec	EK	1:3
8 019 65 012	ER 25 A u-tec	IK 140 bar	1:3
$n_{max} = 15000 \text{ min}^{-1}$			



Winkel-Bohr- und Fräskopf

radial drilling and milling head

Mittenmaß / center distance H=65

8 030 66 078	ER 32 A u-tec	EK	1:1
8 030 66 090	ER 32 A u-tec	IK 140 bar	1:1
$n_{max} = 6000 \text{ min}^{-1}$			
8 030 67 087	<i>easy quick</i> HT 5	EK	1:1
8 030 67 088	<i>easy quick</i> HT 5	IK 140 bar	1:1
$n_{max} = 6000 \text{ min}^{-1}$			
8 030 66 103	ER 32 A u-tec	EK	2:1
8 030 66 127	ER 32 A u-tec	IK 140 bar	2:1
$n_{max} = 3000 \text{ min}^{-1}$			
8 030 67 116	<i>easy quick</i> HT 5	EK	2:1
8 030 67 117	<i>easy quick</i> HT 5	IK 140 bar	2:1
$n_{max} = 3000 \text{ min}^{-1}$			



Winkel-Bohr- und Fräskopf

radial drilling and milling head

Mittenmaß / center distance H=80

8 030 65 057	ER 25 A u-tec	EK	1:2
8 030 65 020	ER 25 A u-tec	IK 140 bar	1:2
$n_{max} = 12000 \text{ min}^{-1}$			
8 030 66 128	<i>easy quick</i> HT 4	EK	1:2
8 030 66 129	<i>easy quick</i> HT 4	IK 140 bar	1:2
$n_{max} = 12000 \text{ min}^{-1}$			
8 030 65 038	ER 25 A u-tec	EK	1:3
8 030 65 039	ER 25 A u-tec	IK 140 bar	1:3
$n_{max} = 18000 \text{ min}^{-1}$			
8 030 66 130	<i>easy quick</i> HT 4	EK	1:3
8 030 66 131	<i>easy quick</i> HT 4	IK 140 bar	1:3
$n_{max} = 18000 \text{ min}^{-1}$			

► Weitere Ausführungen auf Anfrage
further versions on request

► Zubehör ZB...* accessories ZB...*

► *easy-quick*

► u-tec



Winkel-Bohr- und Fräskopf radial drilling and milling head

Mittenmaß / center distance $H=65$
 $n_{max} = 24000 \text{ min}^{-1}$

8 030 64 015	ER 16 A u-tec	EK	1:4
8 030 64 018	ER 16 A u-tec	IK 140 bar	1:4

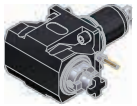

Winkel-Bohr- und Fräskopf radial drilling and milling head

Mittenmaß / center distance $H=65$
 $n_{max} = 6000 \text{ min}^{-1}$

8 031 65 006	Kombidorn/universal arbor 22	EK 1:1
8 031 66 011	Kombidorn/universal arbor 27	EK 1:1
8 031 64 003	Kombidorn/universal arbor 3/4"	EK 1:1
8 031 65 019	Kombidorn/universal arbor 1"	EK 1:1

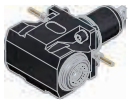

Winkel-Bohr- und Fräskopf radial drilling and milling head

Mittenmaß / center distance $H=65$
 $n_{max} = 6000 \text{ min}^{-1}$
doppelspindel / double spindle

8 039 65 014	2x ER 25 A u-tec	EK	1:1
8 039 66 028	2x ER 32 A u-tec	EK	1:1
8 039 67 001	2x easy quick HT 5	EK	1:1



Schwenkkopf universal head

Mittenmaß / center distance $H=64$
 $n_{max} = 5000 \text{ min}^{-1}$

8 040 64 000	ER 16	EK	1:1
--------------	-------	----	-----



Schwenkkopf universal head

Mittenmaß / center distance $H=60$
Achsversatz / offset $A=35$

8 043 64 003	ER 16 A u-tec	EK	1:1
8 043 64 007	ER 16 A u-tec	IK 140 bar	1:1
$n_{max} = 6000 \text{ min}^{-1}$			
8 043 64 006	ER 16 A u-tec	EK	1:2
8 043 64 012	ER 16 A u-tec	IK 140 bar	1:2
$n_{max} = 12000 \text{ min}^{-1}$			



Winkel-Scheibenfräserkopf radial disk mill head

$\pm 10^\circ$ drehbar
 $\pm 10^\circ$ turnable

Mittenmaß / center distance $H=87,5$
auf 0° absteckbar / 0° can be pinned
 $n_{max} = 3000 \text{ min}^{-1}$
kein Kühlmittel / no coolant

8 037 65 002	$\varnothing 22$	2:1
8 037 66 000	$\varnothing 27$	2:1
8 037 64 007	$\varnothing 3/4"$	2:1
8 037 65 007	$\varnothing 1"$	2:1

► Weitere Ausführungen auf Anfrage
further versions on request

► Zubehör ZB...* 
accessories ZB...*

► easy-quick 

► u-tec 

festе Werkzeuge static tool holders

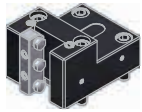

Kombi-Drehstahlhalter
universal turning holder

- | | | |
|--------------|--------------------|----|
| 8 224 15 000 | Vierkant/square 25 | EK |
| 8 224 15 008 | Vierkant/square 1" | EK |



Doppel-Drehstahlhalter
double turning holder

- | | | |
|--------------|--------------------|----|
| 8 251 15 000 | Vierkant/square 25 | EK |
| 8 251 15 007 | Vierkant/square 1" | EK |



Abstechhalter / Drehhalter
cut-off holder / turning holder

- | | | | |
|--------------|--------------------|-----|----|
| 8 224 12 011 | Vierkant/square 25 | (1) | EK |
| 8 224 12 021 | Vierkant/square 1" | (1) | EK |
| 8 225 12 003 | Vierkant/square 25 | (2) | EK |
| 8 225 12 006 | Vierkant/square 1" | (2) | EK |
| 8 224 12 010 | Vierkant/square 25 | (3) | EK |
| 8 224 12 022 | Vierkant/square 1" | (3) | EK |
| 8 225 12 002 | Vierkant/square 25 | (4) | EK |
| 8 225 12 007 | Vierkant/square 1" | (4) | EK |

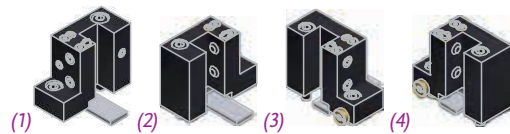

Abstechhalter
cut-off holder

- | | | | |
|--------------|-------|-----|----|
| 8 224 13 008 | SH 32 | (1) | EK |
| 8 224 13 009 | SH 32 | (2) | EK |

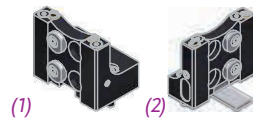

Abstechhalter
cut-off holder

höhenverstellbar / height adjustable

- | | | | |
|--------------|-------|-----|-----------|
| 8 320 13 004 | SH 32 | (1) | IK 70 bar |
| 8 320 13 017 | SH 32 | (2) | IK 70 bar |
| 8 320 13 016 | SH 32 | (3) | IK 70 bar |



Abstechhalter
cut-off holder

höhenverstellbar / height adjustable

- | | | | |
|--------------|-----------------|-----|-----------|
| 8 320 19 002 | HORN System 845 | (1) | IK 70 bar |
| 8 320 19 017 | HORN System 845 | (2) | IK 70 bar |

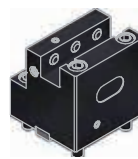

Plandrehhalter
facing holder

- | | | |
|--------------|--------------------|----|
| 8 244 12 000 | Vierkant/square 25 | EK |
| 8 244 12 006 | Vierkant/square 1" | EK |

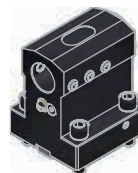

Bohrstangenhalter
boring bar holder

Mittenmaß / center distance H=90

- | | | |
|--------------|---------|-------|
| 8 240 18 000 | ø32 | IK/EK |
| 8 240 19 000 | ø40 | IK/EK |
| 8 240 18 041 | ø1 1/4" | IK/EK |
| 8 240 18 035 | ø1 1/2" | IK/EK |

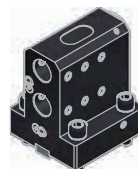

Doppel-Bohrstangenhalter
double boring bar holder

Mittenmaß / center distance H=57,5 / 100

- | | | |
|--------------|--------|-------|
| 8 253 17 007 | 2x ø25 | IK/EK |
| 8 253 17 050 | 2x ø1" | IK/EK |

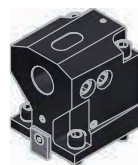

Halte für Wendepplattenbohrer
insert drill holder

Mittenmaß / center distance H=85

- | | | |
|--------------|-----|----|
| 8 240 15 009 | ø16 | IK |
| 8 240 16 011 | ø20 | IK |
| 8 240 17 025 | ø25 | IK |
| 8 240 18 022 | ø32 | IK |
| 8 240 19 019 | ø40 | IK |



► Weitere Ausführungen auf Anfrage
further versions on request

► Zubehör ZB...*
accessories ZB...*

► easy-quick

► u-tec



Spannzangenhalter
collet chuck holder

Mittenmaß / center distance H=90

8 240 16 031 ER 32
8 240 17 060 ER 40

IK/EK
IK/EK



Mehrfach-Bohrstangenhalter
multiple boring bar holder

für ½ Stationen-Takt / for ½ station indexing
Mittenmaß / center distance H=65 / 100

8 253 17 083 3x ø25

IK/EK

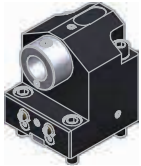

Aufnahmehalter
tool holder

Mittenmaß / center distance H=90

8 240 17 018 easy quick HT 5

IK/EK



Stahlhalter mit rotierender Spitze
tool holder with rotating centering point

Mittenmaß / center distance H=90

8 263 19 010

EK



Doppel-Spannzangenhalter
double collet chuck holder

Mittenmaß / center distance H=90

8 249 16 011 2x ER 32
8 249 17 006 2x ER 40

IK/EK
IK/EK



Stahlhalter für Zentriereinsatz
tool holder for centering insert

Mittenmaß / center distance H=57,5
Preis ohne Zentriereinsatz / price without centering insert

8 261 18 002 ø32

EK



Doppel-Aufnahmehalter
double tool holder

Mittenmaß / center distance H=90

8 249 17 007 2x easy quick HT 5

IK/EK



Abdeckblech
cover plate

8 200 03 001

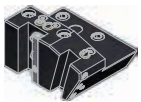

Kombi-Mehrfachdrehhalter
combi multiple holder

für ½ Stationen-Takt / for ½ station indexing

8 251 14 042 3x Vierkant/square 20

EK

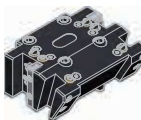

Kombi-Mehrfachdrehhalter
combi multiple holder

für ½ Stationen-Takt / for ½ station indexing

8 251 14 044 6x Vierkant/square 20

EK

► Weitere Ausführungen auf Anfrage
further versions on request

► Zubehör ZB...* 
accessories ZB...*

► easy-quick 

► u-tec 

► *easy-quick HT Schnellwechselsystem*
easy-quick HT fast change system

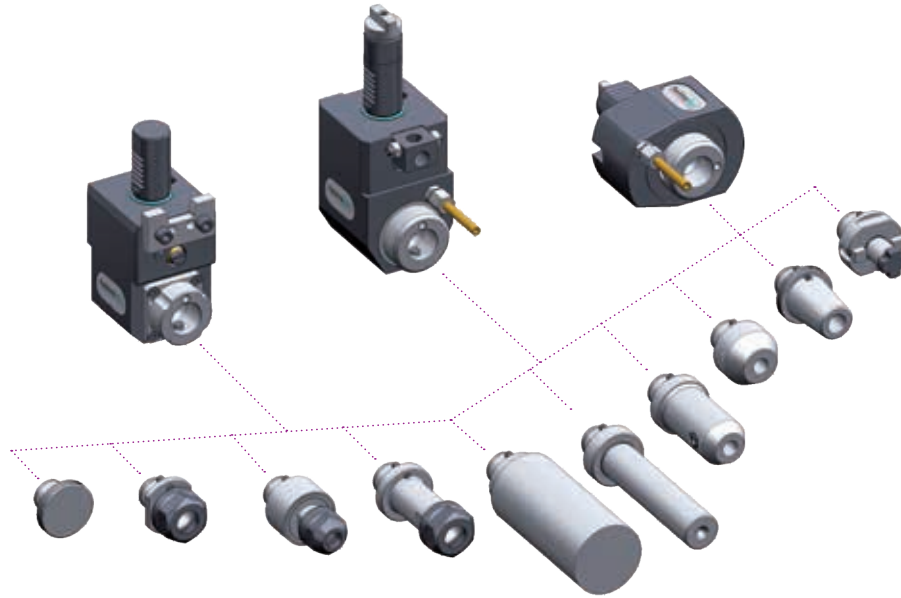

► Ausführungen siehe Katalog
versions see catalogue



heimatec.de
Produkte / easy-quick

heimatec.com
products / easy-quick

► **u-tec® UT Wechselsystem**
u-tec® UT change system

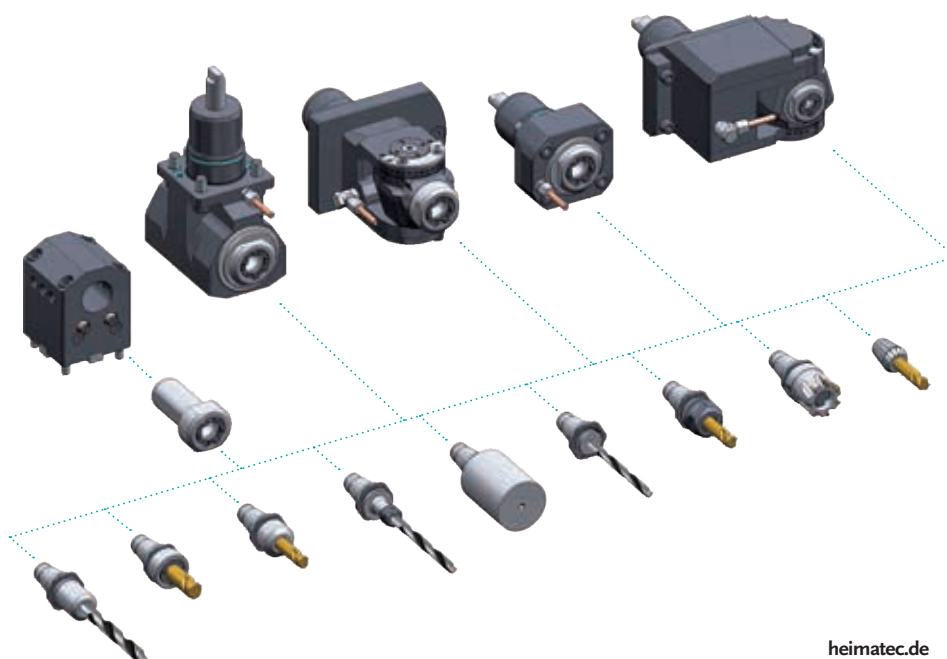

► Ausführungen siehe Katalog
versions see catalogue



heimatec.de
Produkte / u-tec

heimatec.com
products / u-tec

heimatec®

- heimatec®-Niederlassungen
heimatec® overseas branches
- unsere weltweiten Vertretungen
global representations of heimatec®



Hauptsitz/headquarters

heimatec® GmbH
Präzisionswerkzeuge
Carl-Benz-Straße 4
D- 77871 Renchen
Postfach 11 36
D- 77867 Renchen
Tel.: +49 (78 43) 94 66 0
Fax: +49 (78 43) 94 66 66
heimatec.de
info@heimatec.de

heimatec® Inc.
USA
usa.heimatec.com
USA@heimatec.com

heimatec®-Ost, JSC
Russia
ru.heimatec.com
Russia@heimatec.com

heimatec® Ltd.
Taiwan
tw.heimatec.com
Taiwan@heimatec.com

heimatec®
Singapore
sg.heimatec.com
Singapore@heimatec.com

heimatec® India Pvt Ltd.
India
in.heimatec.com
India@heimatec.com

heimatec®
China
cn.heimatec.com
China@heimatec.com