

Werkzeugkatalog

tool catalogue



Nakamura

Super Mill WT 150

90er Revolver (65) / 90 turret (65)



Das Katalog-Werk einschließlich aller seiner Teile ist urheberrechtlich geschützt. Jede Verwertung außerhalb der engen Grenzen des Urheberrechtsgesetzes ist ohne Zustimmung der Rechteinhaber unzulässig und strafbar. Das gilt insbesondere für Vervielfältigungen, Übersetzungen, Mikroverfilmungen und die Einspeicherung und Verarbeitung in elektronischen Systemen.

heimatec® GmbH behält sich Änderungen technischer Art jederzeit ohne Vorankündigung vor. Dies gilt insbesondere bei Anpassungen an neue oder geänderte internationale Normen oder bei Weiterentwicklungen unserer Produkte oder Herstellungsprozesse.

This catalogue, including all its parts, is protected by copyright. Each use outside the restricted limitations of the Copyright Act is inadmissible and liable to prosecution without the consent of heimatec. This is particularly valid for duplication, translation, microfilming and feeding and processing in electronic systems.

heimatec® GmbH reserves the right of technical changes everytime without advance notice, which is particularly valid for adaptations to new or changed international standards, or to developments of our products or manufacturing processes.

Hinweis zu den AGBs:
Diese finden Sie in unserem Internetauftritt unter **heimatec.de**
Home/Impressum/AGB

Terms and conditions:
You will find them on our website **heimatec.com**
Home/Imprint/Terms and Conditions



angetriebene Werkzeuge driven tools



Axial-Bohr- und Fräskopf axial drilling and milling head

$n_{max} = 6000 \text{ min}^{-1}$

8 010 66 076	ER 32 A u-tec	EK	1:1
8 010 66 077	ER 32 A u-tec	IK 25 bar	1:1
8 010 66 088	ER 32 A u-tec	IK 70 bar	1:1
8 010 67 031	easy quick HT 5	EK	1:1
8 010 67 032	easy quick HT 5	IK 25 bar	1:1
8 010 67 093	easy quick HT 5	IK 70 bar	1:1



Axial-Fräskopf axial milling head

$n_{max} = 6000 \text{ min}^{-1}$

8 011 64 001	Kombidorn/universal arbor 16	EK 1:1
8 011 64 008	Kombidorn/universal arbor 3/4"	EK 1:1
8 011 65 005	Kombidorn/universal arbor 22	EK 1:1
8 011 65 008	Kombidorn/universal arbor 1"	EK 1:1
8 011 66 007	Kombidorn/universal arbor 27	EK 1:1



Axial-Bohr- und Fräskopf axial drilling and milling head

$n_{max} = 24000 \text{ min}^{-1}$

8 013 64 005	ER 16 A u-tec	EK	1:4
8 013 64 006	ER 16 A u-tec	IK 70 bar	1:4



Axial-Bohr- und Fräskopf axial drilling and milling head

Achsversatz / offset $A=50$

8 019 65 009	ER 25 A u-tec	EK	1:1
8 019 65 008	ER 25 A u-tec	IK 140 bar	1:1
$n_{max} = 6000 \text{ min}^{-1}$			
8 019 65 013	ER 25 A u-tec	EK	1:2
8 019 65 014	ER 25 A u-tec	IK 140 bar	1:2
$n_{max} = 12000 \text{ min}^{-1}$			
8 019 65 015	ER 25 A u-tec	EK	1:3
8 019 65 016	ER 25 A u-tec	IK 140 bar	1:3
$n_{max} = 18000 \text{ min}^{-1}$			



Winkel-Bohr- und Fräskopf radial drilling and milling head

Mittenmaß / center distance $H=65$
 $n_{max} = 6000 \text{ min}^{-1}$

8 030 66 095	ER 32 A u-tec	EK	1:1
8 030 66 100	ER 32 A u-tec	IK 140 bar	1:1
8 030 67 108	easy quick HT 5	EK	1:1
8 030 67 057	easy quick HT 5	IK 140 bar	1:1



Winkel-Bohr- und Fräskopf radial drilling and milling head

Mittenmaß / center distance $H=65$
 $n_{max} = 3000 \text{ min}^{-1}$

8 030 66 105	ER 32 A u-tec	EK	2:1
8 030 66 118	ER 32 A u-tec	IK 140 bar	2:1



Winkel-Bohr- und Fräskopf radial drilling and milling head

Mittenmaß / center distance $H=77$

8 030 65 058	ER 25 A u-tec	EK	1:2
8 030 65 056	ER 25 A u-tec	IK 140 bar	1:2
$n_{max} = 12000 \text{ min}^{-1}$			
8 030 65 059	ER 25 A u-tec	EK	1:3
8 030 65 060	ER 25 A u-tec	IK 140 bar	1:3
$n_{max} = 18000 \text{ min}^{-1}$			

festе Werkzeuge static tool holders

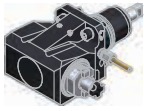

Winkel-Fräskopf radial milling head

Mittenmaß / center distance H=65
 $n_{max} = 6000 \text{ min}^{-1}$

- 8 031 64 004 Kombidorner/universal arbor 16 EK 1:1
- 8 031 65 013 Kombidorner/universal arbor 22 EK 1:1

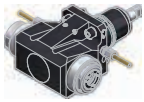

Winkel-Bohr- und Fräskopf radial drilling and milling head

Mittenmaß / center distance H=65
 $n_{max} = 6000 \text{ min}^{-1}$
doppelspindlig / double spindle

- 8 039 66 023 2x ER 32 A u-tec EK 1:1
- 8 039 67 006 2x easy quick HT 5 EK 1:1

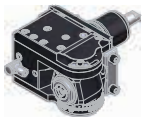

Schwenkkopf universal head

Mittenmaß / center distance H=35
Achsversatz / offset A=60

- 8 043 64 000 ER 16 A u-tec EK 1:1
- 8 043 64 002 ER 16 A u-tec IK 25 bar 1:1
- 8 043 64 010 ER 16 A u-tec EK 1:2
- 8 043 64 011 ER 16 A u-tec IK 25 bar 1:2
- 8 043 65 001 ER 25 A u-tec EK 1:1
- 8 043 65 007 ER 25 A u-tec IK 25 bar 1:1



Winkel-Scheibenfräserkopf radial disk mill head

Mittenmaß / center distance H=87,5
auf 0° absteckbar / 0° can be pinned
 $n_{max} = 3000 \text{ min}^{-1}$
kein Kühlmittel / no coolant

±10° drehbar
±10° turnable

- 8 037 64 000 ø 16 2:1
- 8 037 65 006 ø 22 2:1
- 8 037 66 003 ø 27 2:1



Kombi-Drehstahlhalter universal turning holder

- 8 224 15 004 Vierkant/square 25/20 EK
- 8 224 15 010 Vierkant/square 1" EK



Doppel-Drehstahlhalter double turning holder

- 8 251 12 001 Vierkant/square 25 EK
- 8 251 12 008 Vierkant/square 1" EK



Abstechhalter / Drehhalter cut-off holder / turning holder

schmal
small

- 8 224 13 010 SH 32 (1) EK
- 8 224 13 011 SH 32 (2) EK

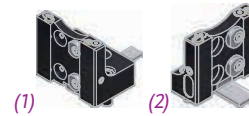

Abstechhalter cut-off holder

heimatec®

höhenverstellbar / height adjustable

- 8 320 13 006 SH 32 (1) IK 70 bar
- 8 320 13 011 SH 32 (2) IK 70 bar
- 8 320 13 012 SH 32 (3) IK 70 bar

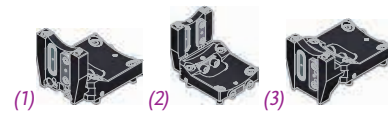

Abstechhalter cut-off holder

pi HORN pi

höhenverstellbar / height adjustable

- 8 320 19 003 HORN System 845 (1) IK 70 bar
- 8 320 19 014 HORN System 845 (2) IK 70 bar

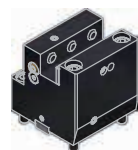

Kombi-Plandrehhalter combi facing holder

- 8 244 12 003 Vierkant/square 25 EK
- 8 244 12 007 Vierkant/square 1" EK

► Weitere Ausführungen auf Anfrage
further versions on request

► Zubehör ZB...*
accessories ZB...*

► easy-quick

► u-tec

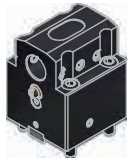

Bohrstangenhalter
boring bar holder

Mittenmaß / center distance H=75

8 240 17 026	ø25	IK/EK
8 240 18 023	ø32	IK/EK
8 240 19 021	ø40	IK/EK
8 240 18 040	ø1 1/4"	IK/EK



Stahlhalter mit rotierender Spitze
tool holder with rotating centering point

Mittenmaß / center distance H=65

8 263 19 017	EK
--------------	----

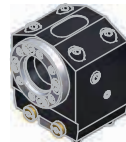

Halter für Zentriereinsatz
center holder

Mittenmaß / center distance H=65

8 261 18 008	ø32	EK
--------------	-----	----



Doppel-Bohrstangenhalter
double boring bar holder

Mittenmaß / center distance H=47,5 / 82,5

8 253 17 023	2x ø25	IK/EK
8 253 17 059	2x ø1"	IK/EK

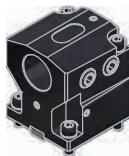

Halter für Wendepplattenbohrer
insert drill holder

Mittenmaß / center distance H=75

8 240 15 010	ø16	IK
8 240 16 013	ø20	IK
8 240 17 027	ø25	IK
8 240 18 024	ø32	IK
8 240 19 022	ø40	IK
8 240 17 036	ø1"	IK



Spannzangenhalter
collet chuck holder

Mittenmaß / center distance H=75

8 240 16 023	ER 32	IK/EK
--------------	-------	-------

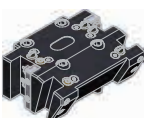

Kombi-Mehrfachdrehhalter **unterer Revolver**
combi multiple holder lower turret

für 1/2 Stationen-Takt / for 1/2 station indexing

8 251 14 011	6x Vierkant/square 20	EK
8 251 14 038	6x Vierkant/square 3/4"	EK



Mehrfach-Bohrstangenhalter **oberer Revolver**
multiple boring bar holder upper turret

für 1/2 Stationen-Takt / for 1/2 station indexing
Mittenmaß / center distance H=57,5 / 97,5

8 253 17 024	3x ø25	IK/EK
8 253 17 077	3x ø1"	IK/EK

▶ Weitere Ausführungen auf Anfrage
further versions on request

▶ Zubehör ZB...* 
accessories ZB...*

▶ easy-quick 

▶ u-tec 

► **easy-quick HT Schnellwechselsystem**
easy-quick HT fast change system

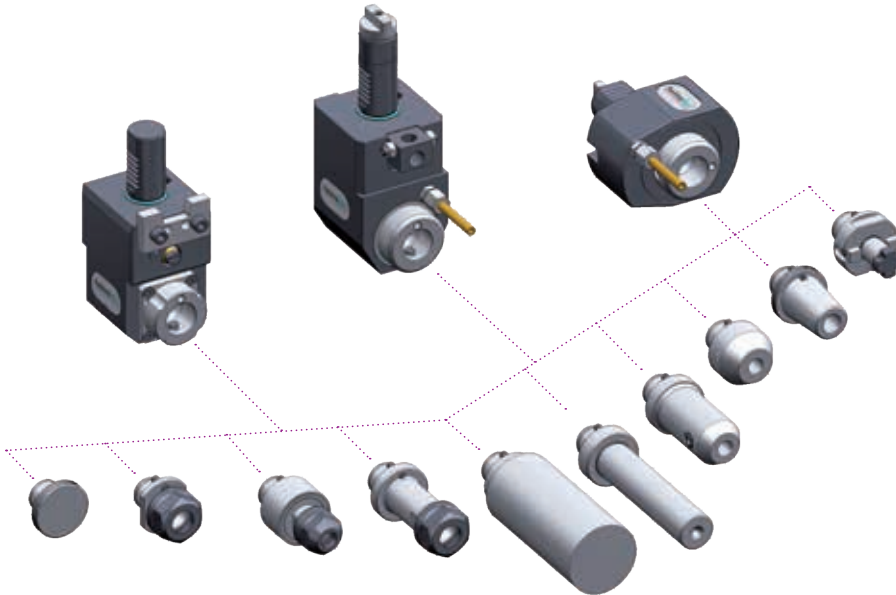

► Ausführungen siehe Katalog
versions see catalogue



heimatec.de
Produkte / easy-quick

heimatec.com
products / easy-quick

► **u-tec® UT Wechselsystem**
u-tec® UT change system

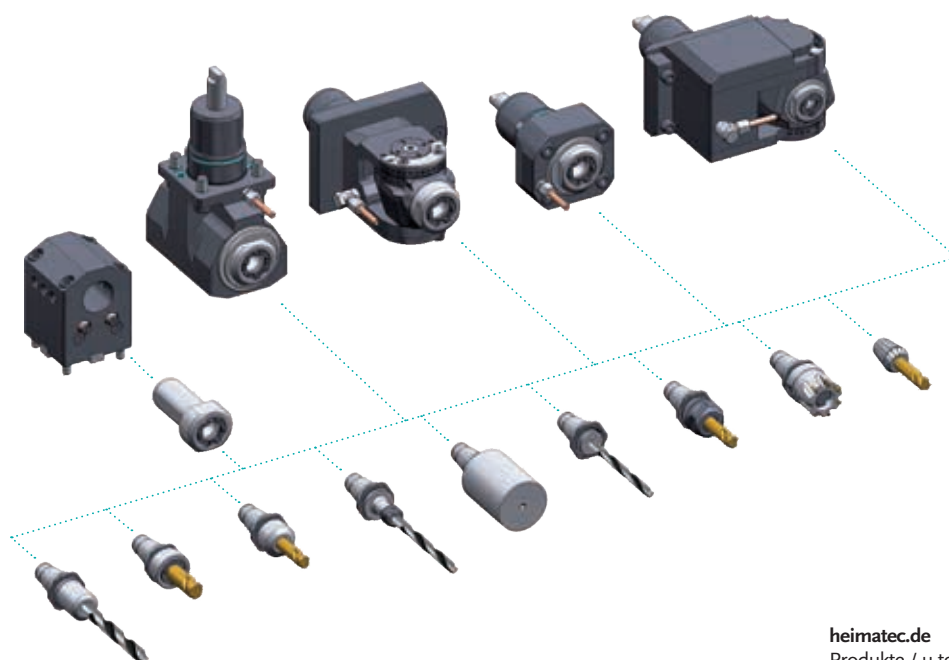

► Ausführungen siehe Katalog
versions see catalogue



heimatec.de
Produkte / u-tec

heimatec.com
products / u-tec

► **Zubehör**
accessories



► Ausführungen siehe Katalog
versions see catalogue



heimatec.de
Produkte / Zubehör

heimatec.com
products / accessories

Notizen
notes

.....

.....

.....

.....

.....

.....

.....

.....

.....

.....

.....

.....

.....

.....

.....

.....

.....

.....

.....

.....

.....

.....

.....

heimatec®

- heimatec®-Niederlassungen
heimatec® overseas branches
- unsere weltweiten Vertretungen
global representations of heimatec®



Hauptsitz/headquarters

heimatec® GmbH
Präzisionswerkzeuge
Carl-Benz-Straße 4
D- 77871 Renchen
Postfach 11 36
D- 77867 Renchen
Tel.: +49 (78 43) 94 66 0
Fax: +49 (78 43) 94 66 66
heimatec.de
info@heimatec.de

heimatec® Inc.
USA
usa.heimatec.com
USA@heimatec.com

heimatec®-Ost, JSC
Russia
ru.heimatec.com
Russia@heimatec.com

heimatec® Ltd.
Taiwan
tw.heimatec.com
Taiwan@heimatec.com

heimatec®
Singapore
sg.heimatec.com
Singapore@heimatec.com

heimatec® India Pvt Ltd.
India
in.heimatec.com
India@heimatec.com

heimatec®
China
cn.heimatec.com
China@heimatec.com