

Nakamura  
**WY-100 V**



# High-tech from heimatec - heimatec - Tools and systems for productive turning and milling

heimatec belongs to the international technology and quality leaders for precision tools and specializes in the development and production of high-precision static and live tools for all CNC lathes, CNC turn-/mill machines and CNC machining centers.

The range of products\* spans from static BMT and VDI tool holders, live tools up to highly complex customer-specific individual solutions. heimatec, headquartered in Renchen, has a own subsidiary in Asia and India and numerous representatives as well as trading partners all over the world.

## \*OUR PRODCUTS

Static tool holders

Live tool units

Precision tools

Tools for turning and machining centres

Tools for swiss type lathes

Tool changing and uick-change systems

Tool systems for gear production

Digital tool management

This catalogue, including all its parts, is protected by copyright. Any use outside the restricted limitations of the Copyright Act without the consent of heimatec is inadmissible and liable to prosecution. This applies in particular to duplication, translation, microfilming and storage and processing in electronic systems.

**heimatec GmbH** reserves the right to make technical changes at any time without giving prior notice. This applies in particular to adjustments at any time to meet new or changed international standards, or in case of further developments of our products or manufacturing processes.

The current version of our General Terms and Conditions can be found on our website.

Part-#	Name
--------	------

**8 010 44 055**

**Axial milling and drill holder ER 20 AX UT**



Weight [kg]:	1.450
Tool drive:	Flat (~DIN 1809)
Shank size [mm]:	44.00
Shank type:	BMT
Tool adaption:	ER 20 A - u-tec
Gear ratio [i]:	1:1
Torque max [Nm]:	16
Rotation max [1/min]:	6000
Rotating direction:	same
Coolant:	EXT
Please note:	Combi bearing

**8 010 44 056**

**Axial milling and drill holder ER 20 AX UT IC**



Weight [kg]:	1.440
Tool drive:	Flat (~DIN 1809)
Shank size [mm]:	44.00
Shank type:	BMT
Tool adaption:	ER 20 A - u-tec
Gear ratio [i]:	1:1
Torque max [Nm]:	16
Rotation max [1/min]:	6000
Rotating direction:	same
Coolant:	IC/Ext
Pressure max [bar]:	25
Please note:	Combi bearing

**8 010 44 071**

**Axial drilling and milling head Weldon 14**

Weight [kg]:	1.640
Tool drive:	Flat (~DIN 1809)
Shank size [mm]:	44.00
Shank type:	BMT
Tool adaption:	Weldon (DIN 1835 b) 14
Gear ratio [i]:	1:1
Torque max [Nm]:	16
Rotation max [1/min]:	6000
Rotating direction:	same
Coolant:	EXT
Please note:	Combi bearing





**8 010 44 085**

**Axial drilling and milling head ER 20 AX UT IC**

Weight [kg]:	1.970
Tool drive:	Flat (~DIN 1809)
Shank size [mm]:	44.00
Shank type:	BMT
Tool adaption:	ER 20 A - u-tec
Gear ratio [i]:	1:1
Torque max [Nm]:	16
Rotation max [1/min]:	10000
Rotating direction:	same
Coolant:	IC/Ext
Pressure max [bar]:	70
Please note:	High pressure version

Part-#	Name	
<b>8 010 44 091</b>	<b>Axial drilling and milling head ER 20 AX UT</b>	
	Weight [kg]:	1.530
	Tool drive:	Flat (~DIN 1809)
	Shank size [mm]:	44.00
	Shank type:	BMT
	Tool adaption:	ER 20 A - u-tec
	Gear ratio [i]:	1:1
	Torque max [Nm]:	32
	Rotation max [1/min]:	12000
	Rotating direction:	same
	Coolant:	EXT
<b>8 010 44 092</b>	<b>Axial drilling and milling head ER 20 AX UT IC</b>	
	Weight [kg]:	1.560
	Tool drive:	Flat (~DIN 1809)
	Shank size [mm]:	44.00
	Shank type:	BMT
	Tool adaption:	ER 20 A - u-tec
	Gear ratio [i]:	1:1
	Torque max [Nm]:	32
	Rotation max [1/min]:	12000
	Rotating direction:	same
	Coolant:	IC/Ext
	Pressure max [bar]:	25
<b>8 010 44 093</b>	<b>Axial drilling and milling head ER 20 AX UT IC</b>	
	Weight [kg]:	2.020
	Tool drive:	Flat (~DIN 1809)
	Shank size [mm]:	44.00
	Shank type:	BMT
	Tool adaption:	ER 20 A - u-tec
	Gear ratio [i]:	1:1
	Torque max [Nm]:	32
	Rotation max [1/min]:	12000
	Rotating direction:	same
	Coolant:	IC/Ext
	Pressure max [bar]:	100
	Please note:	Dryrun possible
<b>8 010 45 081</b>	<b>Axial drilling and milling head Weldon 16</b>	
	Tool drive:	Flat (~DIN 1809)
	Shank size [mm]:	44.00
	Shank type:	BMT
	Tool adaption:	Weldon (DIN 1835 b) 16
	Gear ratio [i]:	1:1
	Torque max [Nm]:	16
	Rotation max [1/min]:	6000
	Rotating direction:	same
	Coolant:	EXT
	Please note:	Combi bearing

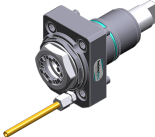
Part-#	Name	
<b>8 010 45 082</b>	<b>Axial drilling and milling head Weldon 16 IC</b>	
	Tool drive:	Flat (~DIN 1809)
	Shank size [mm]:	44.00
	Shank type:	BMT
	Tool adaption:	Weldon (DIN 1835 b) 16
	Gear ratio [i]:	1:1
	Torque max [Nm]:	16
	Rotation max [1/min]:	6000
	Rotating direction:	same
	Coolant:	IC/Ext
	Pressure max [bar]:	25
	Please note:	Combi bearing
<b>8 010 45 160</b>	<b>Axial drilling and milling head ER 25 AX UT</b>	
	Weight [kg]:	1.530
	Tool drive:	Flat (~DIN 1809)
	Shank size [mm]:	44.00
	Shank type:	BMT
	Tool adaption:	ER 25 A - u-tec
	Gear ratio [i]:	1:1
	Torque max [Nm]:	16
	Rotation max [1/min]:	8000
	Rotating direction:	same
	Coolant:	EXT
	Please note:	stronger bearing
<b>8 010 45 170</b>	<b>Axial drilling and milling head ER 25 IC</b>	
	Weight [kg]:	1.550
	Tool drive:	Flat (~DIN 1809)
	Shank size [mm]:	44.00
	Shank type:	BMT
	Tool adaption:	ER 25
	Gear ratio [i]:	1:1
	Torque max [Nm]:	32
	Rotation max [1/min]:	6000
	Rotating direction:	same
	Coolant:	IC/Ext
	Pressure max [bar]:	25
	Please note:	Combi bearing
<b>8 010 45 191</b>	<b>Axial milling and drill holder ER 25 AX UT</b>	
	Tool drive:	Flat (~DIN 1809)
	Shank size [mm]:	44.00
	Shank type:	BMT
	Tool adaption:	ER 25 A - u-tec
	Gear ratio [i]:	1:1
	Torque max [Nm]:	32
	Rotation max [1/min]:	8000
	Rotating direction:	same
	Coolant:	EXT
	Please note:	Combi bearing

Part-#	Name	
	<b>8 010 45 192</b>	<b>Axial milling and drill holder ER 25 AX UT IC</b>
	Weight [kg]:	1.800
	Tool drive:	Flat (~DIN 1809)
	Shank size [mm]:	44.00
	Shank type:	BMT
	Tool adaption:	ER 25 A - u-tec
	Gear ratio [i]:	1:1
	Torque max [Nm]:	32
	Rotation max [1/min]:	8000
	Rotating direction:	same
	Coolant:	IC/Ext
Pressure max [bar]:	25	
Please note:	Combi bearing	
	<b>8 010 45 193</b>	<b>Axial milling and drill holder ER 25 AX UT IC</b>
	Weight [kg]:	2.340
	Tool drive:	Flat (~DIN 1809)
	Shank size [mm]:	44.00
	Shank type:	BMT
	Tool adaption:	ER 25 A - u-tec
	Gear ratio [i]:	1:1
	Torque max [Nm]:	32
	Rotation max [1/min]:	8000
	Rotating direction:	same
	Coolant:	IC/Ext
Pressure max [bar]:	100	
Please note:	Combi bearing; dryrun possible	
	<b>8 010 45 208</b>	<b>Axial drilling and milling head ER 25 AX UT</b>
	Weight [kg]:	1.500
	Tool drive:	Flat (~DIN 1809)
	Shank size [mm]:	44.00
	Shank type:	BMT
	Tool adaption:	ER 25 A - u-tec
	Gear ratio [i]:	1:1
	Torque max [Nm]:	32
	Rotation max [1/min]:	12000
	Rotating direction:	same
	Coolant:	EXT
	<b>8 010 45 209</b>	<b>Axial drilling and milling head ER 25 AX UT IC</b>
	Weight [kg]:	1.750
	Tool drive:	Flat (~DIN 1809)
	Shank size [mm]:	44.00
	Shank type:	BMT
	Tool adaption:	ER 25 A - u-tec
	Gear ratio [i]:	1:1
	Torque max [Nm]:	32
	Rotation max [1/min]:	12000
	Rotating direction:	same
	Coolant:	IC/Ext
Pressure max [bar]:	25	

Part-#

Name

8 010 45 210

**Axial drilling and milling head ER 25 AX UT IC**



Weight [kg]: 1.980  
 Tool drive: Flat (~DIN 1809)  
 Shank size [mm]: 44.00  
 Shank type: BMT  
 Tool adaption: ER 25 A - u-tec  
 Gear ratio [i]: 1:1  
 Torque max [Nm]: 32  
 Rotation max [1/min]: 15000  
 Rotating direction: same  
 Coolant: IC/Ext  
 Pressure max [bar]: 100  
 Please note: Dryrun possible

8 010 46 149

**Axial drilling and milling head HT 4 IC**



Tool drive: Flat (~DIN 1809)  
 Shank size [mm]: 44.00  
 Shank type: BMT  
 Tool adaption: HT 4  
 Gear ratio [i]: 1:1  
 Torque max [Nm]: 16  
 Rotation max [1/min]: 6000  
 Rotating direction: same  
 Coolant: IC/Ext  
 Pressure max [bar]: 25  
 Please note: Combi bearing

8 010 46 277

**Axial drilling and milling head HT 4 IC**

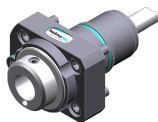

Weight [kg]: 1.400  
 Tool drive: Flat (~DIN 1809)  
 Shank size [mm]: 44.00  
 Shank type: BMT  
 Tool adaption: HT 4  
 Gear ratio [i]: 1:1  
 Torque max [Nm]: 16  
 Rotation max [1/min]: 8000  
 Rotating direction: same  
 Coolant: IC/Ext  
 Pressure max [bar]: 25  
 Please note: stronger bearing

8 010 46 323

**Axial drilling and milling head Weldon 20**



Weight [kg]: 1.940  
 Tool drive: Flat (~DIN 1809)  
 Shank size [mm]: 44.00  
 Shank type: BMT  
 Tool adaption: Weldon (DIN 1835 b) 20  
 Gear ratio [i]: 1:1  
 Torque max [Nm]: 32  
 Rotation max [1/min]: 12000  
 Rotating direction: same  
 Coolant: EXT

Part-#	Name	
<b>8 011 44 017</b>	<b>Axial milling head universal arbor 16</b>	
	Weight [kg]:	1.560
	Tool drive:	Flat (~DIN 1809)
	Shank size [mm]:	44.00
	Shank type:	BMT
	Tool adaption:	Universal arbor 16
	Gear ratio [i]:	1:1
	Torque max [Nm]:	32
	Rotation max [1/min]:	6000
	Rotating direction:	same
	Coolant:	EXT
	Please note:	Combi bearing
<b>8 011 44 018</b>	<b>Axial milling head universal arbor 3/4"</b>	
	Weight [kg]:	1.480
	Tool drive:	Flat (~DIN 1809)
	Shank size [mm]:	44.00
	Shank type:	BMT
	Tool adaption:	Universal arbor 3/4" (19,05mm)
	Gear ratio [i]:	1:1
	Torque max [Nm]:	25
	Rotation max [1/min]:	8000
	Rotating direction:	same
	Coolant:	EXT
	Please note:	Combi bearing
<b>8 011 45 024</b>	<b>Axial milling head universal arbor 22</b>	
	Weight [kg]:	1.620
	Tool drive:	Flat (~DIN 1809)
	Shank size [mm]:	44.00
	Shank type:	BMT
	Tool adaption:	Universal arbor 22
	Gear ratio [i]:	1:1
	Torque max [Nm]:	32
	Rotation max [1/min]:	6000
	Rotating direction:	same
	Coolant:	EXT
	Please note:	Combi bearing
<b>8 011 45 033</b>	<b>Axial milling head universal arbor 1"</b>	
	Tool drive:	Flat (~DIN 1809)
	Shank size [mm]:	44.00
	Shank type:	BMT
	Tool adaption:	Universal arbor 1" (25,4mm)
	Gear ratio [i]:	1:1
	Torque max [Nm]:	16
	Rotation max [1/min]:	6000
	Rotating direction:	same
	Coolant:	EXT
	Please note:	Combi bearing

Part-#	Name
--------	------

**8 013 43 001**



**Axial drilling and milling head ER 11**

Weight [kg]:	1.850
Tool drive:	Flat (~DIN 1809)
Shank size [mm]:	44.00
Shank type:	BMT
Tool adaption:	ER 11
Gear ratio [i]:	1:4
Torque max [Nm]:	2,5
Rotation max [1/min]:	48000
Rotating direction:	same
Coolant:	EXT

**8 013 44 002**



**Axial drilling and milling head ER 16 AX UT**

Weight [kg]:	1.850
Tool drive:	Flat (~DIN 1809)
Shank size [mm]:	44.00
Shank type:	BMT
Tool adaption:	ER 16 A - u-tec
Gear ratio [i]:	1:4
Torque max [Nm]:	5
Rotation max [1/min]:	24000
Rotating direction:	same
Coolant:	EXT

**8 013 44 003**

**Axial drilling and milling head ER 16 AX UT IC**

Tool drive:	Flat (~DIN 1809)
Shank size [mm]:	44.00
Shank type:	BMT
Tool adaption:	ER 16 A - u-tec
Gear ratio [i]:	1:4
Torque max [Nm]:	5
Rotation max [1/min]:	24000
Rotating direction:	same
Coolant:	IC/Ext
Pressure max [bar]:	80

**8 019 44 014**

**Axial drilling and milling head ER 16**

Weight [kg]:	3.860
Notation:	offset; 180° reversible
Tool drive:	Flat (~DIN 1809)
Shank size [mm]:	44.00
Shank type:	BMT
Tool adaption:	ER 16
Gear ratio [i]:	1:2
Torque max [Nm]:	16
Rotation max [1/min]:	12000
Rotating direction:	opposite
Coolant:	EXT
Please note:	Umsetzbarkeit check !
Offset [mm]:	34,5

Part-#	Name	
<b>8 019 44 017</b>	<b>Axial drilling and milling head HT 2</b>	
	Weight [kg]:	3.780
	Notation:	offset; 180° reversible
	Tool drive:	Flat (~DIN 1809)
	Shank size [mm]:	44.00
	Shank type:	BMT
	Tool adaption:	HT 2
	Gear ratio [i]:	1:2
	Torque max [Nm]:	16
	Rotation max [1/min]:	12000
	Rotating direction:	opposite
	Coolant:	EXT
	Please note:	Umsetzbarkeit check !
	Offset [mm]:	34,5
<b>8 019 44 040</b>	<b>Axial drilling and milling head ER 16 AX UT</b>	
	Weight [kg]:	3.780
	Notation:	offset; 180° reversible
	Tool drive:	Flat (~DIN 1809)
	Shank size [mm]:	44.00
	Shank type:	BMT
	Tool adaption:	ER 16 A - u-tec
	Gear ratio [i]:	2:1
	Torque max [Nm]:	40
	Rotation max [1/min]:	3000
	Rotating direction:	opposite
	Coolant:	EXT
	Please note:	Umsetzbarkeit check !
	Offset [mm]:	34,5
<b>8 019 44 050</b>	<b>Axial drilling and milling head ER 16 AX UT</b>	
	Weight [kg]:	3.830
	Notation:	offset; 180° reversible
	Tool drive:	Flat (~DIN 1809)
	Shank size [mm]:	44.00
	Shank type:	BMT
	Tool adaption:	ER 16 A - u-tec
	Gear ratio [i]:	1:3
	Torque max [Nm]:	8
	Rotation max [1/min]:	18000
	Rotating direction:	opposite
	Coolant:	EXT
	Please note:	Umsetzbarkeit check !
	Offset [mm]:	34,5
<b>8 019 44 052</b>	<b>Axial drilling and milling head ER 16 AX UT IC</b>	
	Weight [kg]:	4.530
	Notation:	offset
	Tool drive:	Flat (~DIN 1809)
	Shank size [mm]:	44.00
	Shank type:	BMT
	Tool adaption:	ER 16 A - u-tec
	Gear ratio [i]:	1:3
	Torque max [Nm]:	8
	Rotation max [1/min]:	18000
	Rotating direction:	opposite
	Coolant:	IC/Ext
	Pressure max [bar]:	140

Part-#	Name	
	Please note:	180° reversible
	Offset [mm]:	34,5
<b>8 019 44 108</b>	<b>Axial drilling and milling head ER 16 AX UT</b>	
	Notation:	offset; 180° reversible
	Tool drive:	Flat (~DIN 1809)
	Shank size [mm]:	44.00
	Shank type:	BMT
	Tool adaption:	ER 16 A - u-tec
	Gear ratio [i]:	1:1
	Torque max [Nm]:	16
	Rotation max [1/min]:	8000
	Rotating direction:	opposite
	Coolant:	EXT
	Please note:	Umsetzbarkeit check !
	Offset [mm]:	34,5
<b>8 019 44 109</b>	<b>Axial drilling and milling head ER 16 AX UT IC</b>	
	Weight [kg]:	4.450
	Notation:	offset
	Tool drive:	Flat (~DIN 1809)
	Shank size [mm]:	44.00
	Shank type:	BMT
	Tool adaption:	ER 16 A - u-tec
	Gear ratio [i]:	1:1
	Torque max [Nm]:	16
	Rotation max [1/min]:	8000
	Rotating direction:	opposite
	Coolant:	IC/Ext
	Pressure max [bar]:	140
	Please note:	180° reversible
	Offset [mm]:	34,5
<b>8 019 44 124</b>	<b>Axial drilling and milling head ER 16 AX UT IC</b>	
	Weight [kg]:	4.470
	Notation:	offset
	Tool drive:	Flat (~DIN 1809)
	Shank size [mm]:	44.00
	Shank type:	BMT
	Tool adaption:	ER 16 A - u-tec
	Gear ratio [i]:	2:1
	Torque max [Nm]:	40
	Rotation max [1/min]:	3000
	Rotating direction:	opposite
	Coolant:	IC/Ext
	Pressure max [bar]:	140
	Please note:	180° reversible
	Offset [mm]:	34,5
<b>8 019 44 138</b>	<b>Axial drilling and milling head ER 16 AX UT</b>	
	Weight [kg]:	3.120
	Notation:	offset; 180° reversible
	Tool drive:	Flat (~DIN 1809)
	Shank size [mm]:	44.00
	Shank type:	BMT
	Tool adaption:	ER 16 A - u-tec
	Gear ratio [i]:	1:2



Part-#	Name	
	Torque max [Nm]:	16
	Rotation max [1/min]:	20000
	Rotating direction:	opposite
	Coolant:	EXT
	Please note:	Umsetzbarkeit check !
	Offset [mm]:	34,5
<b>8 030 44 060</b>	<b>Radial drilling and milling head ER 16 AX UT IC</b>	
	Notation:	180° reversible
	Tool drive:	Flat (~DIN 1809)
	Shank size [mm]:	44.00
	Shank type:	BMT
	Tool adaption:	ER 16 A - u-tec
	Gear ratio [i]:	1:1
	Torque max [Nm]:	16
	Rotation max [1/min]:	6000
	Rotating direction:	opposite
	Coolant:	IC/Ext
	Pressure max [bar]:	140
	Please note:	Combi bearing
	Center distance [mm]:	60
<b>8 030 44 065</b>	<b>Radial drilling and milling head ER 16 AX UT</b>	
	Weight [kg]:	4.360
	Notation:	180° reversible
	Tool drive:	Flat (~DIN 1809)
	Shank size [mm]:	44.00
	Shank type:	BMT
	Tool adaption:	ER 16 A - u-tec
	Gear ratio [i]:	1:2
	Torque max [Nm]:	8
	Rotation max [1/min]:	12000
	Rotating direction:	same
	Coolant:	EXT
	Please note:	stronger bearing
	Center distance [mm]:	68,5
<b>8 030 44 067</b>	<b>Angle-mill- and drill holder ER 20 AX UT</b>	
	Weight [kg]:	4.000
	Notation:	180° reversible
	Tool drive:	Flat (~DIN 1809)
	Shank size [mm]:	44.00
	Shank type:	BMT
	Tool adaption:	ER 20 A - u-tec
	Gear ratio [i]:	1:1
	Torque max [Nm]:	16
	Rotation max [1/min]:	8000
	Rotating direction:	opposite
	Coolant:	EXT
	Please note:	Combi bearing
	Center distance [mm]:	75

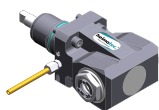

Part-#	Name
--------	------

<b>8 030 44 068</b>	<b>Angle-mill- and drill holder ER 20 AX UT IC</b>
Weight [kg]:	4.300
Notation:	180° reversible
Tool drive:	Flat (~DIN 1809)
Shank size [mm]:	44.00
Shank type:	BMT
Tool adaption:	ER 20 A - u-tec
Gear ratio [i]:	1:1
Torque max [Nm]:	16
Rotation max [1/min]:	6000
Rotating direction:	opposite
Coolant:	IC/Ext
Pressure max [bar]:	140
Please note:	Combi bearing
Center distance [mm]:	75

<b>8 030 44 069</b>	<b>Radial drilling and milling head ER 20 AX UT</b>
Weight [kg]:	4.520
Notation:	180° reversible
Tool drive:	Flat (~DIN 1809)
Shank size [mm]:	44.00
Shank type:	BMT
Tool adaption:	ER 20 A - u-tec
Gear ratio [i]:	1:2
Torque max [Nm]:	8
Rotation max [1/min]:	12000
Rotating direction:	same
Coolant:	EXT
Please note:	stronger bearing
Center distance [mm]:	68,5

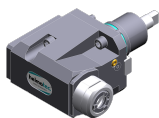

<b>8 030 44 070</b>	<b>Radial drilling and milling head ER 20 AX UT IC</b>
Weight [kg]:	4.570
Notation:	180° reversible
Tool drive:	Flat (~DIN 1809)
Shank size [mm]:	44.00
Shank type:	BMT
Tool adaption:	ER 20 A - u-tec
Gear ratio [i]:	1:2
Torque max [Nm]:	8
Rotation max [1/min]:	12000
Rotating direction:	same
Coolant:	IC/Ext
Pressure max [bar]:	140
Please note:	stronger bearing
Center distance [mm]:	68,5

<b>8 030 44 083</b>	<b>Radial drilling and milling head ER 16 AX UT</b>
Weight [kg]:	4.580
Notation:	180° reversible
Tool drive:	Flat (~DIN 1809)
Shank size [mm]:	44.00
Shank type:	BMT
Tool adaption:	ER 16 A - u-tec
Gear ratio [i]:	1:2
Torque max [Nm]:	8
Rotation max [1/min]:	12000
Rotating direction:	same

Part-#	Name
--------	------

Coolant:	EXT
Please note:	stronger bearing; Umsetzbarkeit check !
Center distance [mm]:	75

**8 030 44 172 Radial drilling and milling head ER 16 AX UT**

Weight [kg]:	4.360
Notation:	180° reversible
Tool drive:	Flat (~DIN 1809)
Shank size [mm]:	44.00
Shank type:	BMT
Tool adaption:	ER 16 A - u-tec
Gear ratio [i]:	1:3
Torque max [Nm]:	8
Rotation max [1/min]:	18000
Rotating direction:	same
Coolant:	EXT
Center distance [mm]:	68,5

**8 030 44 173 Radial drilling and milling head ER 16 AX UT IC**

Weight [kg]:	4.380
Notation:	180° reversible
Tool drive:	Flat (~DIN 1809)
Shank size [mm]:	44.00
Shank type:	BMT
Tool adaption:	ER 16 A - u-tec
Gear ratio [i]:	1:3
Torque max [Nm]:	8
Rotation max [1/min]:	18000
Rotating direction:	same
Coolant:	IC/Ext
Pressure max [bar]:	140
Center distance [mm]:	68,5

**8 030 44 179 Radial drilling and milling head ER 16 AX UT**



Weight [kg]:	4.040
Notation:	180° reversible
Tool drive:	Flat (~DIN 1809)
Shank size [mm]:	44.00
Shank type:	BMT
Tool adaption:	ER 16 A - u-tec
Gear ratio [i]:	1:4
Torque max [Nm]:	5
Rotation max [1/min]:	24000
Rotating direction:	opposite
Coolant:	EXT
Center distance [mm]:	60

**8 030 44 180 Radial drilling and milling head ER 16 AX UT IC**



Weight [kg]:	4.300
Notation:	180° reversible
Tool drive:	Flat (~DIN 1809)
Shank size [mm]:	44.00
Shank type:	BMT
Tool adaption:	ER 16 A - u-tec
Gear ratio [i]:	1:4
Torque max [Nm]:	5
Rotation max [1/min]:	24000

Part-#	Name
--------	------

Rotating direction:	opposite
Coolant:	IC/Ext
Pressure max [bar]:	140
Center distance [mm]:	60

**8 030 44 214 Radial drilling and milling head ER 20 AX UT**

Weight [kg]:	4.750
Notation:	180° reversible
Tool drive:	Flat (~DIN 1809)
Shank size [mm]:	44.00
Shank type:	BMT
Tool adaption:	ER 20 A - u-tec
Gear ratio [i]:	1:2
Torque max [Nm]:	8
Rotation max [1/min]:	12000
Rotating direction:	same
Coolant:	EXT
Please note:	stronger bearing; check applicability !
Center distance [mm]:	75

**8 030 44 225 Radial drilling and milling head ER 20 AX UT**



Weight [kg]:	3.830
Notation:	180° reversible
Tool drive:	Flat (~DIN 1809)
Shank size [mm]:	44.00
Shank type:	BMT
Tool adaption:	ER 20 A - u-tec
Gear ratio [i]:	1:1
Torque max [Nm]:	32
Rotation max [1/min]:	12000
Rotating direction:	opposite
Coolant:	EXT
Center distance [mm]:	60

**8 030 44 226 Radial drilling and milling head ER 20 AX UT IC**

Weight [kg]:	4.250
Notation:	180° reversible
Tool drive:	Flat (~DIN 1809)
Shank size [mm]:	44.00
Shank type:	BMT
Tool adaption:	ER 20 A - u-tec
Gear ratio [i]:	1:1
Torque max [Nm]:	32
Rotation max [1/min]:	12000
Rotating direction:	opposite
Coolant:	IC/Ext
Pressure max [bar]:	140
Center distance [mm]:	60

**8 030 44 237 Angle-mill- and drill holder ER 20 AX UT**



Weight [kg]:	3.880
Notation:	180° reversible
Tool drive:	Flat (~DIN 1809)
Shank size [mm]:	44.00
Shank type:	BMT
Tool adaption:	ER 20 A - u-tec
Gear ratio [i]:	1:1

Part-#	Name	
		Torque max [Nm]: 32 Rotation max [1/min]: 8000 Rotating direction: opposite Coolant: EXT Please note: Combi bearing Center distance [mm]: 60
<b>8 030 44 238</b>	<b>Angle-mill- and drill holder ER 20 AX UT IC</b>	
		Notation: 180° reversible Tool drive: Flat (~DIN 1809) Shank size [mm]: 44.00 Shank type: BMT Tool adaption: ER 20 A - u-tec Gear ratio [i]: 1:1 Torque max [Nm]: 32 Rotation max [1/min]: 8000 Rotating direction: opposite Coolant: IC/Ext Pressure max [bar]: 140 Please note: Combi bearing Center distance [mm]: 60
<b>8 030 45 158</b>	<b>Radial drilling and milling head ER 25 AX UT</b>	
		Weight [kg]: 4.520 Notation: 180° reversible Tool drive: Flat (~DIN 1809) Shank size [mm]: 44.00 Shank type: BMT Tool adaption: ER 25 A - u-tec Gear ratio [i]: 2:1 Torque max [Nm]: 32 Rotation max [1/min]: 3000 Rotating direction: opposite Coolant: EXT Please note: Combi bearing Center distance [mm]: 72
<b>8 030 45 218</b>	<b>Radial drilling and milling head ER 25 AX UT IC</b>	
		Weight [kg]: 5.040 Notation: 180° reversible Version: Special Tool drive: Flat (~DIN 1809) Shank size [mm]: 44.00 Shank type: BMT Tool adaption: ER 25 A - u-tec Gear ratio [i]: 2:1 Torque max [Nm]: 32 Rotation max [1/min]: 3000 Rotating direction: opposite Coolant: IC/Ext Pressure max [bar]: 140 Please note: Combi bearing Center distance [mm]: 72

Part-#	Name	
<b>8 030 45 326</b>	<b>Radial drilling and milling head C 3 IC</b>	
	Notation:	180° reversible
	Tool drive:	Flat (~DIN 1809)
	Shank size [mm]:	44.00
	Shank type:	BMT
	Tool adaption:	heimatec Capto(TM) C 3
	Gear ratio [i]:	1:1
	Torque max [Nm]:	25
	Rotation max [1/min]:	8000
	Rotating direction:	opposite
	Coolant:	IC/Ext
	Pressure max [bar]:	140
	Please note:	Check applicability; note tool length!
	Center distance [mm]:	58
<b>8 030 45 328</b>	<b>Radial drilling and milling head ER 25 AX UT IC</b>	
	Weight [kg]:	4.537
	Notation:	180° reversible
	Tool drive:	Flat (~DIN 1809)
	Shank size [mm]:	44.00
	Shank type:	BMT
	Tool adaption:	ER 25 A - u-tec
	Gear ratio [i]:	1:1
	Torque max [Nm]:	16
	Rotation max [1/min]:	8000
	Rotating direction:	opposite
	Coolant:	IC/Ext
	Pressure max [bar]:	140
	Please note:	stronger bearing
	Center distance [mm]:	75
<b>8 030 45 540</b>	<b>Angle-mill- and drill holder ER 25 AX UT</b>	
	Weight [kg]:	4.190
	Notation:	180° reversible
	Tool drive:	Flat (~DIN 1809)
	Shank size [mm]:	44.00
	Shank type:	BMT
	Tool adaption:	ER 25 A - u-tec
	Gear ratio [i]:	1:1
	Torque max [Nm]:	32
	Rotation max [1/min]:	8000
	Rotating direction:	opposite
	Coolant:	EXT
	Please note:	Combi bearing
	Center distance [mm]:	60
<b>8 030 45 560</b>	<b>Radial drilling and milling head Weldon 3/4"</b>	
	Weight [kg]:	4.420
	Notation:	180° reversible
	Tool drive:	Flat (~DIN 1809)
	Shank size [mm]:	44.00
	Shank type:	BMT
	Tool adaption:	Weldon (DIN 1835 b) 3/4" (19,05mm)
	Gear ratio [i]:	2:1
	Torque max [Nm]:	32
	Rotation max [1/min]:	4000
	Rotating direction:	opposite
	Coolant:	EXT

Part-#	Name
--------	------

Please note: Combi bearing  
Center distance [mm]: 60

**8 030 45 574**



**Radial drilling and milling head ER 25 AX UT**  
Weight [kg]: 3.740  
Notation: 180° reversible  
Tool drive: Flat (~DIN 1809)  
Shank size [mm]: 44.00  
Shank type: BMT  
Tool adaption: ER 25 A - u-tec  
Gear ratio [i]: 1:1  
Torque max [Nm]: 32  
Rotation max [1/min]: 12000  
Rotating direction: opposite  
Coolant: EXT  
Center distance [mm]: 60

**8 030 45 575**



**Radial drilling and milling head ER 25 AX UT IC**  
Weight [kg]: 4.600  
Notation: 180° reversible  
Tool drive: Flat (~DIN 1809)  
Shank size [mm]: 44.00  
Shank type: BMT  
Tool adaption: ER 25 A - u-tec  
Gear ratio [i]: 1:1  
Torque max [Nm]: 32  
Rotation max [1/min]: 12000  
Rotating direction: opposite  
Coolant: IC/Ext  
Pressure max [bar]: 140  
Center distance [mm]: 60

**8 030 45 609**

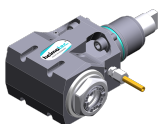



**Angle-mill- and drill holder ER 25 AX UT**  
Weight [kg]: 3.900  
Notation: 180° reversible  
Tool drive: Flat (~DIN 1809)  
Shank size [mm]: 44.00  
Shank type: BMT  
Tool adaption: ER 25 A - u-tec  
Gear ratio [i]: 1:1  
Torque max [Nm]: 32  
Rotation max [1/min]: 8000  
Rotating direction: opposite  
Coolant: EXT  
Please note: Combi bearing  
Center distance [mm]: 60

**8 030 45 610**



**Angle-mill- and drill holder ER 25 AX UT IC**  
Weight [kg]: 4.240  
Notation: 180° reversible  
Tool drive: Flat (~DIN 1809)  
Shank size [mm]: 44.00  
Shank type: BMT  
Tool adaption: ER 25 A - u-tec  
Gear ratio [i]: 1:1  
Torque max [Nm]: 32

Part-#	Name	
	Rotation max [1/min]:	8000
	Rotating direction:	opposite
	Coolant:	IC/Ext
	Pressure max [bar]:	140
	Please note:	Combi bearing
	Center distance [mm]:	60
<b>8 030 46 266</b>	<b>Radial drilling and milling head HT 4</b>	
	Weight [kg]:	4.020
	Notation:	180° reversible
	Tool drive:	Flat (~DIN 1809)
	Shank size [mm]:	44.00
	Shank type:	BMT
	Tool adaption:	HT 4
	Gear ratio [i]:	1:1
	Torque max [Nm]:	32
	Rotation max [1/min]:	12000
	Rotating direction:	opposite
	Coolant:	EXT
	Pressure max [bar]:	140
	Center distance [mm]:	60
<b>8 030 46 267</b>	<b>Radial drilling and milling head HT 4 IC</b>	
	Weight [kg]:	4.250
	Notation:	180° reversible
	Tool drive:	Flat (~DIN 1809)
	Shank size [mm]:	44.00
	Shank type:	BMT
	Tool adaption:	HT 4
	Gear ratio [i]:	1:1
	Torque max [Nm]:	32
	Rotation max [1/min]:	12000
	Rotating direction:	opposite
	Coolant:	IC/Ext
	Pressure max [bar]:	140
	Center distance [mm]:	60
<b>8 030 46 337</b>	<b>Radial drilling and milling head HT 4 IC</b>	
	Weight [kg]:	4.310
	Notation:	180° reversible
	Tool drive:	Flat (~DIN 1809)
	Shank size [mm]:	44.00
	Shank type:	BMT
	Tool adaption:	HT 4
	Gear ratio [i]:	1:1
	Torque max [Nm]:	16
	Rotation max [1/min]:	6000
	Rotating direction:	opposite
	Coolant:	IC/Ext
	Pressure max [bar]:	140
	Please note:	Combi bearing
	Center distance [mm]:	75

Part-#	Name	
<b>8 030 46 503</b>	<b>Radial drilling and milling head HT 4</b>	
	Weight [kg]:	3.540
	Notation:	180° reversible
	Tool drive:	Flat (~DIN 1809)
	Shank size [mm]:	44.00
	Shank type:	BMT
	Tool adaption:	HT 4
	Gear ratio [i]:	1:1
	Torque max [Nm]:	16
	Rotation max [1/min]:	8000
	Rotating direction:	opposite
	Coolant:	EXT
	Please note:	stronger bearing
	Center distance [mm]:	60
<b>8 030 46 504</b>	<b>Radial drilling and milling head HT 4 IC</b>	
	Weight [kg]:	3.790
	Notation:	180° reversible
	Tool drive:	Flat (~DIN 1809)
	Shank size [mm]:	44.00
	Shank type:	BMT
	Tool adaption:	HT 4
	Gear ratio [i]:	1:1
	Torque max [Nm]:	16
	Rotation max [1/min]:	8000
	Rotating direction:	opposite
	Coolant:	IC/Ext
	Pressure max [bar]:	140
	Please note:	stronger bearing
	Center distance [mm]:	60
<b>8 031 40 000</b>	<b>Radial milling head arbor 5</b>	
	Weight [kg]:	2.480
	Notation:	180° reversible
	Version:	Special
	Tool drive:	Flat (~DIN 1809)
	Shank size [mm]:	44.00
	Shank type:	BMT
	Tool adaption:	Arbor 5
	Gear ratio [i]:	1:1
	Torque max [Nm]:	10
	Rotation max [1/min]:	6000
	Rotating direction:	opposite
	Coolant:	EXT
	Please note:	with interchangeable arbor
	Center distance [mm]:	60
<b>8 031 44 032</b>	<b>Radial polygon head arbor 16</b>	
	Notation:	180° reversible
	Tool drive:	Flat (~DIN 1809)
	Shank size [mm]:	44.00
	Shank type:	BMT
	Tool adaption:	Polygon arbor 16
	Gear ratio [i]:	1:1
	Torque max [Nm]:	32
	Rotation max [1/min]:	8000
	Rotating direction:	opposite
	Coolant:	EXT

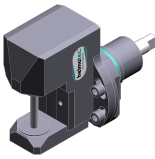
Part-#	Name	
	Please note:	Combi bearing
	Center distance [mm]:	60
<b>8 031 44 046</b>	<b>Radial polygon head arbor 16</b>	
	Weight [kg]:	5.000
	Notation:	180° reversible
	Tool drive:	Flat (~DIN 1809)
	Shank size [mm]:	44.00
	Shank type:	BMT
	Tool adaption:	Polygon arbor 16
	Gear ratio [i]:	2:1
	Torque max [Nm]:	32
	Rotation max [1/min]:	3000
	Rotating direction:	opposite
	Coolant:	EXT
	Please note:	Combi bearing
	Center distance [mm]:	72
<b>8 031 45 040</b>	<b>Radial milling head universal arbor 22</b>	
	Weight [kg]:	4.730
	Notation:	180° reversible
	Tool drive:	Flat (~DIN 1809)
	Shank size [mm]:	44.00
	Shank type:	BMT
	Tool adaption:	Universal arbor 22
	Gear ratio [i]:	2:1
	Torque max [Nm]:	32
	Rotation max [1/min]:	3000
	Rotating direction:	opposite
	Coolant:	EXT
	Please note:	Combi bearing
	Center distance [mm]:	72
<b>8 037 41 000</b>	<b>Radial disk mill head arbor 8</b>	
	Tool drive:	Flat (~DIN 1809)
	Shank size [mm]:	44.00
	Shank type:	BMT
	Tool adaption:	Arbor 8
	Gear ratio [i]:	2:1
	Torque max [Nm]:	32
	Rotation max [1/min]:	4000
	Rotating direction:	opposite
	Coolant:	no
	Center distance [mm]:	78
<b>8 037 42 000</b>	<b>Radial disk mill head arbor 10</b>	
	Weight [kg]:	5.020
	Tool drive:	Flat (~DIN 1809)
	Shank size [mm]:	44.00
	Shank type:	BMT
	Tool adaption:	Arbor 10
	Gear ratio [i]:	2:1
	Torque max [Nm]:	32
	Rotation max [1/min]:	4000
	Rotating direction:	opposite
	Coolant:	no
	Center distance [mm]:	78

Part-#	Name
--------	------

**8 037 43 003**

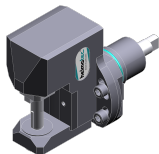

**Radial disk mill head arbor 13**

Tool drive: Flat (~DIN 1809)  
 Shank size [mm]: 44.00  
 Shank type: BMT  
 Tool adaption: Arbor 13  
 Gear ratio [i]: 2:1  
 Torque max [Nm]: 32  
 Rotation max [1/min]: 4000  
 Rotating direction: opposite  
 Coolant: no  
 Center distance [mm]: 78

**8 037 44 012**

**Radial disk mill head arbor 16**

Weight [kg]: 5.300  
 Tool drive: Flat (~DIN 1809)  
 Shank size [mm]: 44.00  
 Shank type: BMT  
 Tool adaption: Arbor 16  
 Gear ratio [i]: 2:1  
 Torque max [Nm]: 32  
 Rotation max [1/min]: 4000  
 Rotating direction: opposite  
 Coolant: no  
 Center distance [mm]: 78

**8 039 44 032**

**Radial drilling and milling head ER 16 AX UT**



Weight [kg]: 3.780  
 Notation: 180° reversible  
 Version: double spindle  
 Tool drive: Flat (~DIN 1809)  
 Shank size [mm]: 44.00  
 Shank type: BMT  
 Tool adaption: ER 16 A - u-tec  
 Gear ratio [i]: 1:1  
 Torque max [Nm]: 16  
 Rotation max [1/min]: 6000  
 Rotating direction: same/opposite  
 Coolant: EXT  
 Please note: stronger bearing  
 Center distance [mm]: 60

**8 039 44 058**

**Radial drilling and milling head ER 16 AX UT**

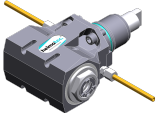
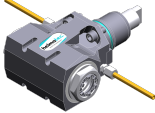
Weight [kg]: 4.690  
 Notation: 180° reversible  
 Employment for: Main- and sub spindle  
 Version: double spindle  
 Tool drive: Flat (~DIN 1809)  
 Shank size [mm]: 44.00  
 Shank type: BMT  
 Tool adaption: ER 16 A - u-tec  
 Gear ratio [i]: 1:2  
 Torque max [Nm]: 8  
 Rotation max [1/min]: 16000  
 Rotating direction: same/opposite  
 Coolant: EXT  
 Please note: stronger bearing  
 Center distance [mm]: 68,5

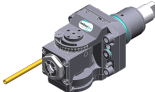
Part-#	Name	
<b>8 039 44 059</b>	<b>Radial drilling and milling head ER 16 AX UT</b>	
	Weight [kg]:	4.660
	Notation:	180° reversible
	Employment for:	Main- and sub spindle
	Version:	double spindle
	Tool drive:	Flat (~DIN 1809)
	Shank size [mm]:	44.00
	Shank type:	BMT
	Tool adaption:	ER 16 A - u-tec
	Gear ratio [i]:	1:3
	Torque max [Nm]:	6
	Rotation max [1/min]:	20000
	Rotating direction:	same/opposite
	Coolant:	EXT
	Please note:	stronger bearing
	Center distance [mm]:	68,5
<b>8 039 44 094</b>	<b>Radial drilling and milling head ER 20 AX UT</b>	
	Weight [kg]:	4.140
	Notation:	180° reversible
	Version:	double spindle
	Tool drive:	Flat (~DIN 1809)
	Shank size [mm]:	44.00
	Shank type:	BMT
	Tool adaption:	ER 20 A - u-tec
	Gear ratio [i]:	1:1
	Torque max [Nm]:	32
	Rotation max [1/min]:	12000
	Rotating direction:	same/opposite
	Coolant:	EXT
	Please note:	stronger bearing
	Center distance [mm]:	60
<b>8 039 45 009</b>	<b>Radial drilling and milling head ER 25 AX UT</b>	
	Weight [kg]:	4.080
	Notation:	180° reversible
	Version:	double spindle
	Tool drive:	Flat (~DIN 1809)
	Shank size [mm]:	44.00
	Shank type:	BMT
	Tool adaption:	ER 25 A - u-tec
	Gear ratio [i]:	1:1
	Torque max [Nm]:	32
	Rotation max [1/min]:	12000
	Rotating direction:	same/opposite
	Coolant:	EXT
	Please note:	stronger bearing
	Center distance [mm]:	60
<b>8 040 43 003</b>	<b>Universal head ± 90° adjustable ER 11 AX</b>	
	Weight [kg]:	3.550
	Tool drive:	Flat (~DIN 1809)
	Shank size [mm]:	44.00
	Shank type:	BMT
	Tool adaption:	ER 11 A
	Gear ratio [i]:	1:1
	Torque max [Nm]:	10

Part-#	Name	
	Rotation max [1/min]:	6000
	Rotating direction:	same
	Coolant:	EXT
	Center distance [mm]:	67
<b>8 040 44 025</b>	<b>Universal head ± 90° adjustable HT 2</b>	
	Weight [kg]:	3.560
	Tool drive:	Flat (~DIN 1809)
	Shank size [mm]:	44.00
	Shank type:	BMT
	Tool adaption:	HT 2
	Gear ratio [i]:	1:1
	Torque max [Nm]:	10
	Rotation max [1/min]:	6000
	Rotating direction:	same
	Coolant:	EXT
	Center distance [mm]:	67
<b>8 040 44 031</b>	<b>Universal head ± 90° adjustable ER 16</b>	
	Weight [kg]:	3.580
	Tool drive:	Flat (~DIN 1809)
	Shank size [mm]:	44.00
	Shank type:	BMT
	Tool adaption:	ER 16
	Gear ratio [i]:	1:1
	Torque max [Nm]:	10
	Rotation max [1/min]:	6000
	Rotating direction:	same
	Coolant:	EXT
	Center distance [mm]:	67
<b>8 040 44 110</b>	<b>Universal head ± 90° adjustable ER 16 AX UT</b>	
	Weight [kg]:	3.800
	Tool drive:	Flat (~DIN 1809)
	Shank size [mm]:	44.00
	Shank type:	BMT
	Tool adaption:	ER 16 A - u-tec
	Gear ratio [i]:	1:1
	Torque max [Nm]:	16
	Rotation max [1/min]:	12000
	Rotating direction:	same
	Coolant:	EXT
	Center distance [mm]:	58
<b>8 040 44 111</b>	<b>Universal head ± 90° adjustable ER 16 AX UT IC</b>	
	Weight [kg]:	3.040
	Tool drive:	Flat (~DIN 1809)
	Shank size [mm]:	44.00
	Shank type:	BMT
	Tool adaption:	ER 16 A - u-tec
	Gear ratio [i]:	1:1
	Torque max [Nm]:	16
	Rotation max [1/min]:	12000
	Rotating direction:	same
	Coolant:	IC/Ext
	Pressure max [bar]:	140
	Center distance [mm]:	58

Part-#	Name
--------	------

**8 040 44 116**    **Universal head ± 90° adjustable ER 16 AX UT**



Tool drive:	Flat (~DIN 1809)
Shank size [mm]:	44.00
Shank type:	BMT
Tool adaption:	ER 16 A - u-tec
Gear ratio [i]:	1:2
Torque max [Nm]:	8
Rotation max [1/min]:	20000
Rotating direction:	same
Coolant:	EXT
Pressure max [bar]:	140
Center distance [mm]:	58

**8 040 44 117**    **Universal head ± 90° adjustable ER 16 AX UT IC**



Tool drive:	Flat (~DIN 1809)
Shank size [mm]:	44.00
Shank type:	BMT
Tool adaption:	ER 16 A - u-tec
Gear ratio [i]:	1:2
Torque max [Nm]:	8
Rotation max [1/min]:	20000
Rotating direction:	same
Coolant:	IC/Ext
Pressure max [bar]:	140
Center distance [mm]:	58

**8 043 43 000**    **Universal head + 90°    adj. ER11 AX**

Weight [kg]:	4.040
Notation:	offset
Tool drive:	Flat (~DIN 1809)
Shank size [mm]:	44.00
Shank type:	BMT
Tool adaption:	ER 11 A
Gear ratio [i]:	1:1
Torque max [Nm]:	10
Rotation max [1/min]:	6000
Rotating direction:	opposite
Coolant:	EXT
Please note:	180° reversible
Center distance [mm]:	25
Offset [mm]:	72

**8 043 43 001**    **Universal head +155°    adj. ER11 AX**

Weight [kg]:	4.200
Notation:	offset; 180° reversible
Tool drive:	Flat (~DIN 1809)
Shank size [mm]:	44.00
Shank type:	BMT
Tool adaption:	ER 11 A
Gear ratio [i]:	1:2
Torque max [Nm]:	5
Rotation max [1/min]:	12000
Rotating direction:	opposite
Coolant:	EXT
Center distance [mm]:	25
Offset [mm]:	74

Part-#	Name
--------	------

<b>8 043 43 004</b>	<b>Universal head +155° adj. ER11 AX IC</b>
Weight [kg]:	4.500
Notation:	offset; 180° reversible
Tool drive:	Flat (~DIN 1809)
Shank size [mm]:	44.00
Shank type:	BMT
Tool adaption:	ER 11 A
Gear ratio [i]:	1:2
Torque max [Nm]:	5
Rotation max [1/min]:	12000
Rotating direction:	opposite
Coolant:	IC/Ext
Pressure max [bar]:	25
Center distance [mm]:	25
Offset [mm]:	74

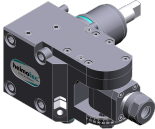
<b>8 043 44 001</b>	<b>Universal head + 90° adjustable ER 16</b>
	
Weight [kg]:	4.070
Notation:	offset
Tool drive:	Flat (~DIN 1809)
Shank size [mm]:	44.00
Shank type:	BMT
Tool adaption:	ER 16
Gear ratio [i]:	1:1
Torque max [Nm]:	10
Rotation max [1/min]:	6000
Rotating direction:	opposite
Coolant:	EXT
Please note:	180° reversible
Center distance [mm]:	25
Offset [mm]:	72

<b>8 043 44 051</b>	<b>Universal head + 60°/- 5° adj. ER16AX UT</b>
	
Weight [kg]:	3.640
Notation:	offset
Tool drive:	Flat (~DIN 1809)
Shank size [mm]:	44.00
Shank type:	BMT
Tool adaption:	ER 16 A - u-tec
Gear ratio [i]:	1:1
Torque max [Nm]:	16
Rotation max [1/min]:	12000
Rotating direction:	opposite
Coolant:	EXT
Please note:	180° reversible
Center distance [mm]:	25
Offset [mm]:	50

<b>8 043 44 052</b>	<b>Universal head + 60°/- 5° adj. ER16AX UTIK</b>
	
Notation:	offset
Tool drive:	Flat (~DIN 1809)
Shank size [mm]:	44.00
Shank type:	BMT
Tool adaption:	ER 16 A - u-tec
Gear ratio [i]:	1:1
Torque max [Nm]:	16
Rotation max [1/min]:	12000

Part-#	Name	
	Rotating direction:	opposite
	Coolant:	IC/Ext
	Pressure max [bar]:	140
	Please note:	180° reversible
	Center distance [mm]:	25
	Offset [mm]:	50
<b>8 050 44 010</b>	<b>Multispindle drilling head ER 16 AX UT</b>	
	Notation:	offset
	Version:	3-spindles
	Tool drive:	Flat (~DIN 1809)
	Shank size [mm]:	44.00
	Shank type:	BMT
	Tool adaption:	ER 16 A - u-tec
	Gear ratio [i]:	1:1
	Torque max [Nm]:	25
	Rotation max [1/min]:	6000
	Rotating direction:	same
	Coolant:	EXT
	Please note:	2xER 16 A UT offset, 1x centered
<b>8 050 44 011</b>	<b>Multispindle drilling head ER 16 AX UT</b>	
	Weight [kg]:	3.810
	Notation:	offset; 180° reversible
	Version:	2-spindles in short version
	Tool drive:	Flat (~DIN 1809)
	Shank size [mm]:	44.00
	Shank type:	BMT
	Tool adaption:	ER 16 A - u-tec
	Gear ratio [i]:	1:1
	Torque max [Nm]:	20
	Rotation max [1/min]:	6000
	Rotating direction:	same
	Coolant:	EXT
	Offset [mm]:	50
<b>8 050 44 018</b>	<b>Multispindle drilling head ER 16 AX UT</b>	
	Weight [kg]:	4.830
	Notation:	offset; 180° reversible
	Version:	2-spindles
	Tool drive:	Flat (~DIN 1809)
	Shank size [mm]:	44.00
	Shank type:	BMT
	Tool adaption:	ER 16 A - u-tec
	Gear ratio [i]:	1:2
	Torque max [Nm]:	8
	Rotation max [1/min]:	12000
	Rotating direction:	same
	Coolant:	EXT
	Offset [mm]:	50

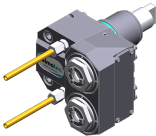
Part-#	Name		
	<b>8 050 44 019</b>	<b>Multispindle drilling head ER 16 AX UT</b>	
		Notation:	offset; 180° reversible
		Version:	2-spindles
		Tool drive:	Flat (~DIN 1809)
		Shank size [mm]:	44.00
		Shank type:	BMT
		Tool adaption:	ER 16 A - u-tec
		Gear ratio [i]:	1:1
		Torque max [Nm]:	25
		Rotation max [1/min]:	6000
		Rotating direction:	same
		Coolant:	EXT
		Offset [mm]:	50
	<b>8 050 44 021</b>	<b>Multispindle drilling head ER 16 AX UT</b>	
		Weight [kg]:	3.770
		Notation:	offset; 180° reversible
		Version:	2-spindles in short version
		Tool drive:	Flat (~DIN 1809)
		Shank size [mm]:	44.00
		Shank type:	BMT
		Tool adaption:	ER 16 A - u-tec
		Gear ratio [i]:	1:2
		Torque max [Nm]:	8
		Rotation max [1/min]:	12000
		Rotating direction:	same
		Coolant:	EXT
	Offset [mm]:	50	
	<b>8 050 44 024</b>	<b>Multispindle drilling head ER 16 AX UT IC</b>	
		Weight [kg]:	4.840
		Notation:	offset; 180° reversible
		Version:	2-spindles
		Tool drive:	Flat (~DIN 1809)
		Shank size [mm]:	44.00
		Shank type:	BMT
		Tool adaption:	ER 16 A - u-tec
		Gear ratio [i]:	1:2
		Torque max [Nm]:	8
		Rotation max [1/min]:	12000
		Rotating direction:	same
		Coolant:	IC/Ext
	Pressure max [bar]:	25	
	Offset [mm]:	50	
	<b>8 050 44 069</b>	<b>Multispindle drilling head ER 16 AX UT</b>	
		Weight [kg]:	4.060
		Notation:	offset; 180° reversible
		Version:	2-spindles
		Tool drive:	Flat (~DIN 1809)
		Shank size [mm]:	44.00
		Shank type:	BMT
		Tool adaption:	ER 16 A - u-tec
		Gear ratio [i]:	1:1
		Torque max [Nm]:	32/Sp.
		Rotation max [1/min]:	12000
		Rotating direction:	same

Part-#

Name

Coolant: EXT  
Offset [mm]: 50

8 050 44 070

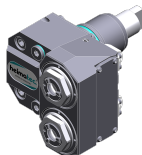

**Multispindle drilling head ER 16 AX UT IC**

Weight [kg]: 4.150  
Notation: offset; 180° reversible  
Tool drive: Flat (~DIN 1809)  
Shank size [mm]: 44.00  
Shank type: BMT  
Tool adaption: ER 16 A - u-tec  
Gear ratio [i]: 1:1  
Torque max [Nm]: 32/Sp.  
Rotation max [1/min]: 12000  
Rotating direction: same  
Coolant: IC/Ext  
Pressure max [bar]: 140  
Offset [mm]: 50

8 050 44 071

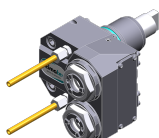

**Multispindle drilling head ER 20 AX UT**

Weight [kg]: 4.160  
Notation: offset; 180° reversible  
Tool drive: Flat (~DIN 1809)  
Shank size [mm]: 44.00  
Shank type: BMT  
Tool adaption: ER 20 A - u-tec  
Gear ratio [i]: 1:1  
Torque max [Nm]: 32/Sp.  
Rotation max [1/min]: 12000  
Rotating direction: same  
Coolant: EXT  
Offset [mm]: 50

8 053 44 068



**Multispindle radial head ER 16 AX UT**

Notation: 180° reversible  
Version: 2-spindles  
Tool drive: Flat (~DIN 1809)  
Shank size [mm]: 44.00  
Shank type: BMT  
Tool adaption: ER 16 A - u-tec  
Gear ratio [i]: 1:1  
Torque max [Nm]: 32/Sp  
Rotation max [1/min]: 12000  
Rotating direction: same  
Coolant: EXT  
Pressure max [bar]: 140  
Center distance [mm]: 60

8 053 44 070





**Multispindle radial head ER 16 AX UT**

Weight [kg]: 5.600  
Notation: 180° reversible  
Version: 2-spindles  
Tool drive: Flat (~DIN 1809)  
Shank size [mm]: 44.00  
Shank type: BMT  
Tool adaption: ER 16 A - u-tec  
Gear ratio [i]: 1:2

Part-#	Name	
	Torque max [Nm]:	16/Sp
	Rotation max [1/min]:	24000
	Rotating direction:	same
	Coolant:	EXT
	Center distance [mm]:	60
<b>8 053 44 071</b>	<b>Multispindle radial head ER 16 AX UTIK</b>	
	Weight [kg]:	5.600
	Notation:	180° reversible
	Version:	2-spindles
	Tool drive:	Flat (~DIN 1809)
	Shank size [mm]:	44.00
	Shank type:	BMT
	Tool adaption:	ER 16 A - u-tec
	Gear ratio [i]:	1:2
	Torque max [Nm]:	16/Sp
	Rotation max [1/min]:	24000
	Rotating direction:	same
	Coolant:	IC/Ext
	Pressure max [bar]:	140
	Center distance [mm]:	60
<b>8 068 44 000</b>	<b>Radial whirling unit HW 46</b>	
	Weight [kg]:	4.960
	Notation:	180° reversible
	Tool drive:	Flat (~DIN 1809)
	Shank size [mm]:	44.00
	Shank type:	BMT
	Tool adaption:	HW 46
	Gear ratio [i]:	1:1
	Torque max [Nm]:	16
	Rotation max [1/min]:	8000
	Rotating direction:	same
	Coolant:	no
	Please note:	without cutting inserts carrier
	Center distance [mm]:	63
<b>8 200 03 011</b>	<b>Cover plate</b>	
	Weight [kg]:	0.214
	Shank type:	BMT
<b>8 202 10 005</b>	<b>Basic holder longitudinal seat FN 12</b>	
	Weight [kg]:	0.720
	Notation:	180° reversible
	Shank type:	BMT
	Machine adaption:	Centering key b 20
	Tool adaption:	Interface FN 12
	Coolant:	EXT
<b>8 209 48 001</b>	<b>Adapter for sensor Renishaw RLP</b>	
	Weight [kg]:	0.980
	Notation:	180° reversible
	Shank size [mm]:	44.00
	Shank type:	BMT
	Coolant:	no





Part-#	Name	
<b>8 224 11 012</b>	<b>Cut-off holder sq. 20</b>	
	Weight [kg]:	0.920
	Employment for:	right cutting tools
	Version:	Edge on side of turret
	Shank type:	BMT
	Machine adaption:	Centering key b 20
	Tool adaption:	Sq. 20
	Coolant:	EXT
<b>8 224 11 013</b>	<b>Cut-off holder sq. 20</b>	
	Weight [kg]:	0.890
	Employment for:	left cutting tools
	Version:	Edge on center of turret
	Shank type:	BMT
	Machine adaption:	Centering key b 20
	Tool adaption:	Sq. 20
	Coolant:	EXT
<b>8 224 11 014</b>	<b>Turning holder sq. 3/4"</b>	
	Employment for:	left cutting tools
	Version:	Edge on center of turret
	Shank type:	BMT
	Machine adaption:	Centering key b 20
	Tool adaption:	Sq. 3/4" (19,05mm)
	Coolant:	EXT
<b>8 224 11 015</b>	<b>Cut-off holder sq. 3/4"</b>	
	Weight [kg]:	0.900
	Employment for:	right cutting tools
	Version:	Edge on side of turret
	Shank type:	BMT
	Machine adaption:	Centering key b 20
	Tool adaption:	Sq. 3/4" (19,05mm)
	Coolant:	EXT
<b>8 224 12 008</b>	<b>Cut-off holder SH 26</b>	
	Weight [kg]:	1.010
	Employment for:	Cut-off tool 26
	Version:	Clampshaft on turret center
	Shank type:	BMT
	Machine adaption:	Centering key b 20
	Tool adaption:	Clampshaft SH 26
	Coolant:	EXT
<b>8 224 12 009</b>	<b>Cut-off holder SH 26</b>	
	Weight [kg]:	1.120
	Employment for:	for cut-off tool 26
	Version:	Clampshaft on turret side
	Shank type:	BMT
	Machine adaption:	Centering key b 20
	Tool adaption:	Clampshaft SH 26
	Coolant:	EXT

Part-#	Name	
<b>8 224 13 006</b>	<b>Cut-off holder SH 32</b>	
	Weight [kg]:	0.800
	Employment for:	Cut-off tool 32
	Version:	Clampshaft on turret center
	Shank type:	BMT
	Machine adaption:	Centering key b 20
	Tool adaption:	Clampshaft SH 32
	Coolant:	EXT
<b>8 224 14 007</b>	<b>Universal turning holder sq. 20</b>	
	Weight [kg]:	2.030
	Notation:	180° reversible
	Shank type:	BMT
	Machine adaption:	Centering key b 20
	Tool adaption:	Sq. 20
		Sq. 20
	Coolant:	EXT
<b>8 224 14 008</b>	<b>Universal turning holder sq. 3/4"</b>	
	Weight [kg]:	1.970
	Notation:	180° reversible
	Shank type:	BMT
	Machine adaption:	Centering key b 20
	Tool adaption:	Sq. 3/4" (19,05mm)
		Sq. 3/4" (19,05mm)
	Coolant:	EXT
<b>8 224 14 017</b>	<b>Universal turning holder sq. 20</b>	
	Notation:	180° reversible
	Version:	short
	Shank type:	BMT
	Machine adaption:	Centering key b 20
	Tool adaption:	Sq. 20
		Sq. 20
	Coolant:	EXT
<b>8 224 14 024</b>	<b>Universal turning holder sq. 20 IC</b>	
	Weight [kg]:	1.970
	Notation:	180° reversible
	Shank type:	BMT
	Machine adaption:	Centering key b 20
	Tool adaption:	Sq. 20
		Sq. 20
	Coolant:	IC/Ext
	Pressure max [bar]:	100
	Please note:	Key rail
<b>8 224 14 030</b>	<b>Universal turning holder sq. 3/4" IC</b>	
	Weight [kg]:	1.700
	Notation:	180° reversible
	Shank type:	BMT
	Machine adaption:	Centering key b 20
	Tool adaption:	Sq. 3/4" (19,05mm)
		Sq. 3/4" (19,05mm)
	Coolant:	IC/Ext
	Pressure max [bar]:	100



Part-#	Name	
	Please note:	Key rail
<b>8 225 11 006</b>	<b>Cut-off holder sq. 20</b>	
	Weight [kg]:	0.900
	Employment for:	left cutting tools
	Version:	Edge on side of turret
	Shank type:	BMT
	Machine adaption:	Centering key b 20
	Tool adaption:	Sq. 20
	Coolant:	EXT
<b>8 225 11 007</b>	<b>Cut-off holder sq. 20</b>	
	Weight [kg]:	0.900
	Employment for:	right cutting tools
	Version:	Edge on center of turret
	Shank type:	BMT
	Machine adaption:	Centering key b 20
	Tool adaption:	Sq. 20
	Coolant:	EXT
<b>8 225 11 008</b>	<b>Cut-off holder sq. 3/4"</b>	
	Weight [kg]:	0.910
	Employment for:	left cutting tools
	Version:	Edge on side of turret
	Shank type:	BMT
	Machine adaption:	Centering key b 20
	Tool adaption:	Sq. 3/4" (19,05mm)
	Coolant:	EXT
<b>8 229 15 006</b>	<b>Tool holder C 3 IC</b>	
	Weight [kg]:	1.880
	Notation:	180° reversible
	Version:	right
	Shank type:	BMT
	Machine adaption:	Centering key b 20
	Tool adaption:	heimatec Capto(TM) C 3
	Coolant:	IC
	Please note:	Check applicability, tool length check!
	Offset [mm]:	45
<b>8 240 15 007</b>	<b>Insert drill holder 16 IC</b>	
	Weight [kg]:	4.540
	Notation:	180° reversible
	Shank type:	BMT
	Tool adaption:	Whistle-Notch (DIN 1835 E) 16
	Coolant:	IC
	Center distance [mm]:	75
<b>8 240 15 011</b>	<b>Collet chuck holder ER 25</b>	
	Weight [kg]:	1.910
	Notation:	180° reversible
	Shank type:	BMT
	Machine adaption:	Centering key b 20
	Tool adaption:	ER 25
	Coolant:	IC/Ext
	Center distance [mm]:	60



Part-#	Name	
<b>8 240 15 024</b>	<b>Collet chuck holder ER 25 AX UT</b>	
	Notation:	180° reversible
	Shank type:	BMT
	Machine adaption:	Centering key b 20
	Tool adaption:	ER 25 A - u-tec
	Coolant:	IC/Ext
	Center distance [mm]:	75
<b>8 240 15 025</b>	<b>Collet chuck holder ER 25 AX UT</b>	
	Weight [kg]:	2.100
	Notation:	180° reversible
	Shank type:	BMT
	Machine adaption:	Centering key b 20
	Tool adaption:	ER 25 A - u-tec
	Coolant:	IC/Ext
	Center distance [mm]:	60
<b>8 240 15 042</b>	<b>Tool holder C 3 IC</b>	
	Weight [kg]:	2.300
	Notation:	180° reversible
	Version:	offset; right
	Shank type:	BMT
	Machine adaption:	Centering key b 20
	Tool adaption:	heimatec Capto(TM) C 3
	Coolant:	IC
	Please note:	Check applicability; note tool length!
	Center distance [mm]:	70
<b>8 240 15 043</b>	<b>Tool holder C 3 IC</b>	
	Weight [kg]:	2.470
	Notation:	180° reversible
	Version:	right
	Shank type:	BMT
	Machine adaption:	Centering key b 20
	Tool adaption:	heimatec Capto(TM) C 3
	Coolant:	IC
	Please note:	Check applicability; note tool length
	Center distance [mm]:	70
<b>8 240 16 007</b>	<b>Boring bar holder Ø 20</b>	
	Weight [kg]:	2.130
	Notation:	180° reversible
	Shank type:	BMT
	Machine adaption:	Centering key b 20
	Tool adaption:	Ø 20
	Coolant:	IC/Ext
	Center distance [mm]:	75
<b>8 240 16 068</b>	<b>Tool holder C 4 IC</b>	
	Notation:	180° reversible
	Version:	offset; right
	Shank type:	BMT
	Machine adaption:	Centering key b 20
	Tool adaption:	heimatec Capto(TM) C 4
	Coolant:	IC
	Pressure max [bar]:	100

Part-#	Name	
	Please note: Center distance [mm]:	Check applicability; note tool length! 75
<b>8 240 17 009</b>	<b>Boring bar holder Ø 25</b>	
	Weight [kg]: Machine adaption: Tool adaption: Coolant: Center distance [mm]:	1.740 Centering key b 20 Ø 25 IC/Ext 60
<b>8 240 17 020</b>	<b>Boring bar holder Ø 25</b>	
	Weight [kg]: Notation: Shank type: Machine adaption: Tool adaption: Coolant: Center distance [mm]:	2.050 180° reversible BMT Centering key b 20 Ø 25 IC/Ext 75
<b>8 240 17 029</b>	<b>Boring bar holder Ø 1"</b>	
	Weight [kg]: Notation: Shank type: Machine adaption: Tool adaption: Coolant: Center distance [mm]:	2.050 180° reversible BMT Centering key b 20 Ø 1" (25,4mm) IC/Ext 75
<b>8 240 17 083</b>	<b>Boring bar holder Ø 25</b>	
	Notation: Version: Shank type: Machine adaption: Tool adaption: Coolant: Please note: Center distance [mm]:	180° reversible special offset BMT Centering key b 20 Ø 25 IC/Ext Tool holder on turret center 60
<b>8 240 17 086</b>	<b>Boring bar holder Ø 25</b>	
	Weight [kg]: Notation: Version: Shank type: Machine adaption: Tool adaption: Coolant: Please note: Center distance [mm]:	3.540 180° reversible offset BMT Centering key b 20 Ø 25 IC/Ext Tool adaption on turret center 75



Part-#	Name	
<b>8 240 18 025</b>	<b>Boring bar holder Ø 32</b>	
	Weight [kg]:	3.610
	Notation:	180° reversible
	Version:	offset
	Shank type:	BMT
	Machine adaption:	Centering key b 20
	Tool adaption:	Ø 32
	Coolant:	IC/Ext
	Please note:	Tool adaption to turret center
	Center distance [mm]:	75
<b>8 240 18 027</b>	<b>Boring bar holder Ø 32</b>	
	Weight [kg]:	2.900
	Notation:	180° reversible
	Version:	offset
	Shank type:	BMT
	Machine adaption:	Centering key b 20
	Tool adaption:	Ø 32
	Coolant:	IC/Ext
	Please note:	Tool holder on turret center
	Center distance [mm]:	60
<b>8 240 18 048</b>	<b>Boring bar holder Ø 1 1/4 "</b>	
	Weight [kg]:	2.750
	Notation:	180° reversible
	Version:	offset
	Shank type:	BMT
	Machine adaption:	Centering key b 20
	Tool adaption:	Ø 1 1/4" (31,75mm)
	Coolant:	IC/Ext
	Please note:	Tool holder on turret center
	Center distance [mm]:	60
<b>8 240 18 052</b>	<b>Boring bar holder Ø 1 1/4 "</b>	
	Weight [kg]:	3.140
	Notation:	180° reversible
	Shank type:	BMT
	Machine adaption:	Centering key b 20
	Tool adaption:	Ø 1 1/4" (31,75mm)
	Coolant:	IC/Ext
	Center distance [mm]:	75
<b>8 240 18 076</b>	<b>Boring bar holder Ø 32</b>	
	Weight [kg]:	3.400
	Notation:	180° reversible
	Version:	offset
	Shank type:	BMT
	Machine adaption:	Centering key b 20
	Tool adaption:	Ø 32
	Coolant:	IC/Ext
	Please note:	Tool adaption on turret center
	Center distance [mm]:	75

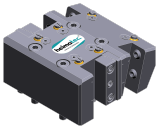

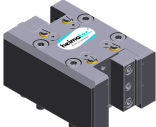
Part-#	Name	
8 244 11 003	<b>Facing holder sq. 20</b>	
	Weight [kg]:	2.550
	Notation:	180° reversible
	Shank type:	BMT
	Machine adaption:	Centering key b 20
	Tool adaption:	Sq. 20
	Coolant:	EXT
8 244 11 006	<b>Facing holder sq. 3/4"</b>	
	Weight [kg]:	2.460
	Notation:	180° reversible
	Shank type:	BMT
	Machine adaption:	Centering key b 20
	Tool adaption:	Sq. 3/4" (19,05mm)
	Coolant:	EXT
8 249 15 008	<b>Double collet chuck holder ER 25 AX UT</b>	
	Weight [kg]:	3.110
	Notation:	180° reversible
	Shank type:	BMT
	Machine adaption:	Centering key b 20
	Tool adaption:	ER 25 A - u-tec
	Coolant:	IC/Ext
	Center distance [mm]:	75
8 249 15 014	<b>Double tool holder C 3 IC</b>	
	Weight [kg]:	3.500
	Notation:	180° reversible
	Employment for:	Main- and sub spindle
	Shank type:	BMT
	Machine adaption:	Centering key b 20
	Tool adaption:	heimatec Capto(TM) C 3 heimatec Capto(TM) C 3
	Coolant:	IC
	Please note:	Check applicability!; note tool length!
	Center distance [mm]:	70
8 251 11 004	<b>Double turning holder sq. 20</b>	
	Weight [kg]:	3.250
	Notation:	180° reversible
	Employment for:	right cutting tools
	Shank type:	BMT
	Machine adaption:	Centering key b 20
	Tool adaption:	Sq. 20 Sq. 20
	Coolant:	EXT
8 251 11 005	<b>Double turning holder sq. 16</b>	
	Weight [kg]:	3.360
	Notation:	180° reversible
	Shank type:	BMT
	Machine adaption:	Centering key b 20
	Tool adaption:	Sq. 16
	Coolant:	EXT

Part-#	Name	
<b>8 251 11 008</b>	<b>Double turning holder sq. 3/4"</b>	
	Weight [kg]:	3.240
	Notation:	180° reversible
	Employment for:	right cutting tools
	Shank type:	BMT
	Machine adaption:	Centering key b 20
	Tool adaption:	Sq. 3/4" (19,05mm)
		Sq. 3/4" (19,05mm)
	Coolant:	EXT
<b>8 251 13 020</b>	<b>Combi multiple holder 3x sq. 3/4" IC</b>	
	Weight [kg]:	2.280
	Shank type:	BMT
	Machine adaption:	Centering key b 20
	Tool adaption:	Sq. 3/4" (19,05mm)
		Sq. 3/4" (19,05mm)
	Coolant:	IC/Ext
	Pressure max [bar]:	100
	Please note:	Key rail
<b>8 251 13 025</b>	<b>Combi multiple holder 3x sq. 3/4"</b>	
	Weight [kg]:	2.100
	Employment for:	Main- and sub spindle
	Shank type:	BMT
	Machine adaption:	Centering key b 20
	Tool adaption:	Sq. 3/4" (19,05mm)
		Sq. 3/4" (19,05mm)
	Coolant:	EXT
<b>8 251 13 026</b>	<b>Combi multiple holder 6x sq. 3/4" IC</b>	
	Weight [kg]:	3.400
	Employment for:	Main- and sub spindle
	Shank type:	BMT
	Machine adaption:	Centering key b 20
	Tool adaption:	Sq. 3/4"
		Sq. 3/4"
		Sq. 3/4"
		Sq. 3/4"
	Coolant:	IC/Ext
	Pressure max [bar]:	100
	Please note:	Key rail
<b>8 251 14 008</b>	<b>Combi multiple holder 6x sq. 20</b>	
	Weight [kg]:	3.660
	Employment for:	Main- and sub spindle
	Shank type:	BMT
	Machine adaption:	Centering key b 20
	Tool adaption:	Sq. 20
		Sq. 20
		Sq. 20
		Sq. 20
	Coolant:	EXT

Part-#	Name	
<b>8 251 14 010</b>	<b>Combi multiple holder 3x sq. 20</b>	
	Weight [kg]:	2.390
	Shank type:	BMT
	Machine adaption:	Centering key b 20
	Tool adaption:	Sq. 20 Sq. 20
	Coolant:	EXT
<b>8 251 14 014</b>	<b>Combi multiple holder 6x sq. 3/4"</b>	
	Weight [kg]:	3.690
	Employment for:	Main- and sub spindle
	Shank type:	BMT
	Machine adaption:	Centering key b 20
	Tool adaption:	Sq. 3/4" (19,05mm) Sq. 3/4" (19,05mm) Sq. 3/4" (19,05mm) Sq. 3/4" (19,05mm)
	Coolant:	EXT
<b>8 251 14 076</b>	<b>Combi multiple holder 6x sq. 20 IC</b>	
	Weight [kg]:	3.620
	Employment for:	Main- and sub spindle
	Shank type:	BMT
	Machine adaption:	Centering key b 20
	Tool adaption:	Sq. 20 Sq. 20 Sq. 20 Sq. 20
	Coolant:	IC/Ext
	Pressure max [bar]:	100
	Please note:	Key rail
<b>8 251 14 077</b>	<b>Combi multiple holder 3x sq. 20 IC</b>	
	Weight [kg]:	2.270
	Shank type:	BMT
	Machine adaption:	Centering key b 20
	Tool adaption:	Sq. 20 Sq. 20
	Coolant:	IC/Ext
	Pressure max [bar]:	100
	Please note:	Key rail
<b>8 251 14 099</b>	<b>Combi double turning holder sq. 20 IC</b>	
	Weight [kg]:	3.140
	Notation:	180° reversible
	Shank type:	BMT
	Machine adaption:	Centering key b 20
	Tool adaption:	Sq. 20 Sq. 20 Sq. 20 Sq. 20
	Coolant:	IC/Ext
	Pressure max [bar]:	100
	Please note:	Key rail

Part-#	Name	
<b>8 251 14 106</b>	<b>Combi multiple holder 3x sq. 20 IC</b>	
	Weight [kg]:	2.160
	Shank type:	BMT
	Machine adaption:	Centering key b 20
	Tool adaption:	Sq. 20
		Sq. 20
	Coolant:	IC/Ext
	Pressure max [bar]:	100
	Please note:	Key rail
<b>8 251 14 107</b>	<b>Combi multiple holder 6x sq. 20 IC</b>	
	Weight [kg]:	3.280
	Employment for:	Main- and sub spindle
	Shank type:	BMT
	Machine adaption:	Centering key b 20
	Tool adaption:	Sq. 20
		Sq. 20
		Sq. 20
		Sq. 20
	Coolant:	IC/Ext
	Pressure max [bar]:	100
	Please note:	Key rail
<b>8 251 15 036</b>	<b>Multiple tool holder C 3 IC</b>	
	Weight [kg]:	2.340
	Version:	right
	Shank type:	BMT
	Machine adaption:	Centering key b 20
	Tool adaption:	heimatec Capto(TM) C 3
		heimatec Capto(TM) C 3 - 15°
	Coolant:	IC
	Please note:	Check applicability; note tool length
	Offset [mm]:	45
<b>8 253 14 005</b>	<b>Multiple collet chuck holder ER 16 AX UT</b>	
	Weight [kg]:	3.800
	Notation:	180° reversible
	Employment for:	Main- and sub spindle
	Shank type:	BMT
	Machine adaption:	Centering key b 20
	Tool adaption:	ER 16 A - u-tec/2x ER 16 A - u-tec - 15°
		ER 16 A - u-tec/2x ER 16 A - u-tec - 15°
	Coolant:	IC/Ext
	Center distance [mm]:	75
<b>8 253 15 002</b>	<b>Multiple tool holder C 3 IC</b>	
	Weight [kg]:	3.680
	Version:	right
	Shank type:	BMT
	Machine adaption:	Centering key b 20
	Tool adaption:	heimatec Capto(TM) C 3
	Coolant:	IC
	Please note:	Check applicability, note tool length!
	Center distance [mm]:	70

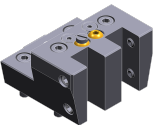
Part-#	Name	
<b>8 253 15 004</b>	<b>Multiple boring bar holder 3x Ø 16</b>	
	Weight [kg]:	3.330
	Notation:	180° reversible
	Shank type:	BMT
	Machine adaption:	Centering key b 20
	Tool adaption:	Ø 16
		Ø 16
	Coolant:	IC/Ext
	Center distance [mm]:	56/80
<b>8 253 15 020</b>	<b>Multiple tool holder C 3 IC</b>	
	Weight [kg]:	3.450
	Version:	offset, right
	Shank type:	BMT
	Machine adaption:	Centering key b 20
	Tool adaption:	heimatec Capto(TM) C 3
	Coolant:	IC
	Please note:	Check applicability, note tool length!
	Center distance [mm]:	70
<b>8 253 17 020</b>	<b>Multiple boring bar holder 2x Ø 25</b>	
	Weight [kg]:	3.290
	Notation:	180° reversible
	Shank type:	BMT
	Machine adaption:	Centering key b 20
	Tool adaption:	Ø 25
		Ø 25 - 15°
	Coolant:	IC/Ext
	Center distance [mm]:	75
<b>8 253 17 033</b>	<b>Multiple boring bar holder 2x Ø 1"</b>	
	Weight [kg]:	3.270
	Notation:	180° reversible
	Shank type:	BMT
	Machine adaption:	Centering key b 20
	Tool adaption:	Ø 1" (25,4mm)
		Ø 1" (25,4mm) - 15°
	Coolant:	IC/Ext
	Center distance [mm]:	75
<b>8 253 17 037</b>	<b>Multiple boring bar holder 2x Ø 25</b>	
	Weight [kg]:	3.590
	Version:	Special
	Shank type:	BMT
	Machine adaption:	Centering key b 20
	Tool adaption:	Ø 25
		Ø 25 - 15°
	Coolant:	IC/Ext
	Center distance [mm]:	80

Part-#	Name	
<b>8 254 11 000</b>	<b>Multiple facing holder 3x sq. 20</b>	
	Weight [kg]:	3.370
	Employment for:	Main- and sub spindle
	Shank type:	BMT
	Machine adaption:	Centering key b 20
	Tool adaption:	Sq. 20
		Sq. 20 - 15°
		Sq. 20 - 15°
	Coolant:	EXT
	Center distance [mm]:	70
<b>8 254 11 001</b>	<b>Multiple facing holder 3x sq. 12</b>	
	Weight [kg]:	3.820
	Employment for:	Main- and sub spindle
	Version:	Special
	Shank type:	BMT
	Machine adaption:	Centering key b 20
	Tool adaption:	Sq. 12
		Sq. 12
	Coolant:	EXT
	Center distance [mm]:	78
<b>8 254 14 000</b>	<b>Multiple facing holder 3x sq. 20</b>	
	Weight [kg]:	3.580
	Employment for:	Main- and sub spindle
	Shank type:	BMT
	Machine adaption:	Centering key b 20
	Tool adaption:	Sq. 20
		Sq. 20
	Coolant:	EXT
	Center distance [mm]:	70
<b>8 259 11 002</b>	<b>Multiple turning holder 2x sq. 20</b>	
	Weight [kg]:	2.080
	Notation:	180° reversible
	Version:	Y-axes offset
	Shank type:	BMT
	Machine adaption:	Centering key b 20
	Tool adaption:	Sq. 20
		Sq. 20
	Coolant:	EXT
<b>8 259 15 015</b>	<b>Multiple tool holder C 3 IC</b>	
	Weight [kg]:	5.880
	Employment for:	Main- and sub spindle
	Version:	right
	Shank type:	BMT
	Machine adaption:	Centering key b 20
	Tool adaption:	heimatec Capto(TM) C 3
		heimatec Capto(TM) C 3
	Coolant:	IC
	Please note:	Check applicability, note tool length!
	Center distance [mm]:	70

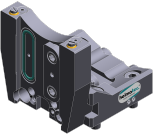
Part-#	Name	
<b>8 259 19 005</b>	<b>Multiple holder Ø 25 and sq. 20</b>	
	Weight [kg]:	3.980
	Notation:	180° reversible
	Employment for:	Main- and sub spindle
	Shank type:	BMT
	Machine adaption:	Centering key b 20
	Tool adaption:	Sq. 20
		Sq. 20
		Sq. 20
		Sq. 20
	Coolant:	IC/Ext
	Center distance [mm]:	75
<b>8 261 18 006</b>	<b>Tool holder for centering insert</b>	
	Weight [kg]:	2.600
	Notation:	180° reversible
	Shank type:	BMT
	Machine adaption:	Centering key slot b 20
	Tool adaption:	Ø 32
	Coolant:	EXT
	Please note:	Price without centering point
	Center distance [mm]:	60
<b>8 320 12 007</b>	<b>Cut-off holder, height adjustable SH 26 IC</b>	
	Weight [kg]:	1.230
	Notation:	180° reversible
	Shank type:	BMT
	Machine adaption:	Centering key b 20
	Tool adaption:	Clampshaft SH 26
	Coolant:	IC/Ext
	Pressure max [bar]:	70
<b>8 320 12 008</b>	<b>Cut-off holder, height adjustable SH 26 IC</b>	
	Weight [kg]:	1.380
	Notation:	180° reversible
	Shank type:	BMT
	Machine adaption:	Centering key b 20
	Tool adaption:	Clampshaft SH 26
	Coolant:	IC/Ext
	Pressure max [bar]:	70
	Please note:	Clampshaft internal
<b>8 320 13 003</b>	<b>Cut-off holder, height adjustable SH 32 IC</b>	
	Weight [kg]:	1.300
	Notation:	180° reversible
	Shank type:	BMT
	Machine adaption:	Centering key b 20
	Tool adaption:	Clampshaft SH 32
	Coolant:	IC/Ext
	Pressure max [bar]:	70

Part-#	Name	
<b>8 320 13 013</b>	<b>Cut-off holder, height adjustable SH 32 IC</b>	
	Weight [kg]:	1.580
	Notation:	180° reversible
	Shank type:	BMT
	Machine adaption:	Centering key b 20
	Tool adaption:	Clampshaft SH 32
	Coolant:	IC/Ext
	Pressure max [bar]:	70
	Please note:	with offset cut-off tool holder; use
<b>8 320 13 014</b>	<b>Cut-off holder, height adjustable SH 32 IC</b>	
	Weight [kg]:	1.490
	Notation:	180° reversible
	Shank type:	BMT
	Machine adaption:	Centering key b 20
	Tool adaption:	Clampshaft SH 32
	Coolant:	IC/Ext
	Pressure max [bar]:	70
	Please note:	Clampshaft internal
<b>8 320 13 032</b>	<b>Cut-off holder, height adjustable SH 32 IC</b>	
	Weight [kg]:	1.430
	Notation:	180° reversible
	Shank type:	BMT
	Machine adaption:	Centering key b 20
	Tool adaption:	Clampshaft SH 32
	Coolant:	IC/Ext
	Pressure max [bar]:	70
	Please note:	Clampshaft internal; cut-off tool able to penetrate the tool holder body
<b>8 320 19 008</b>	<b>Cut-off holder, height adjustable 845 IC</b>	
	Weight [kg]:	1.500
	Notation:	180° reversible
	Shank type:	BMT
	Machine adaption:	Centering key b 20
	Tool adaption:	 System 845
	Coolant:	IC
	Pressure max [bar]:	70
	Please note:	Clampshaft internal





## heimatec.u-tec®

heimatec.com

Products / Tool change systems /  
u-tec® Tool-changing system



versions see catalog

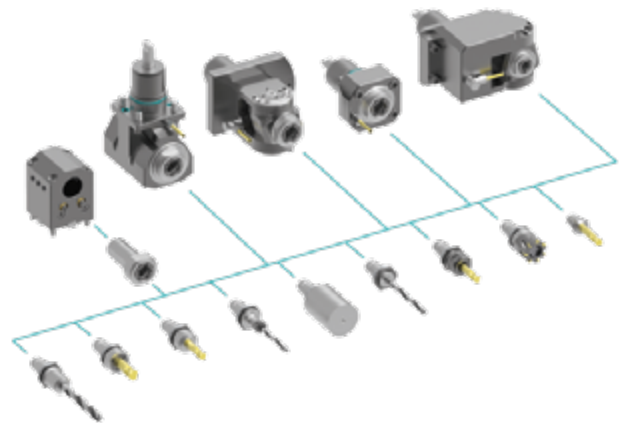

## heimatec.easy-quick

heimatec.com

Products / Tool change systems /  
easy-quick HT quick-changing system



versions see catalog

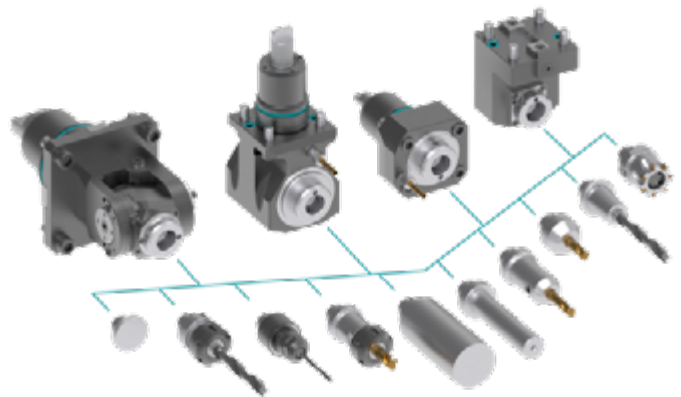

## heimatec.Capto™

heimatec.com

Products / Tool change systems /  
heimatec.Capto™ quick-changing system



versions see catalog

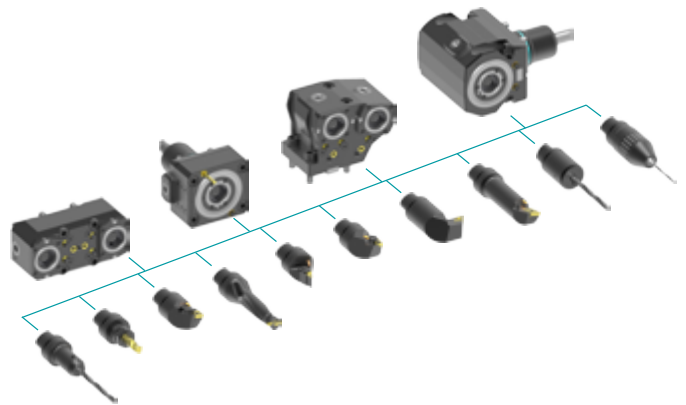

## heimatec.accessories

heimatec.com

Products / Accessories



versions see catalog





● heimatec overseas branches

○ global representations of heimatec

**heimatec**<sup>®</sup>

**heimatec GmbH**  
Präzisionswerkzeuge  
Carl-Benz-Str. 4  
77871 Renchen  
Germany

T +49 7843 9466 0  
[www.heimatec.com](http://www.heimatec.com)  
[info@heimatec.com](mailto:info@heimatec.com)

Please find the contact details of our worldwide trading partners on our website:  
<https://heimatec.com/business-partners>