

# Werkzeugkatalog

tool catalogue

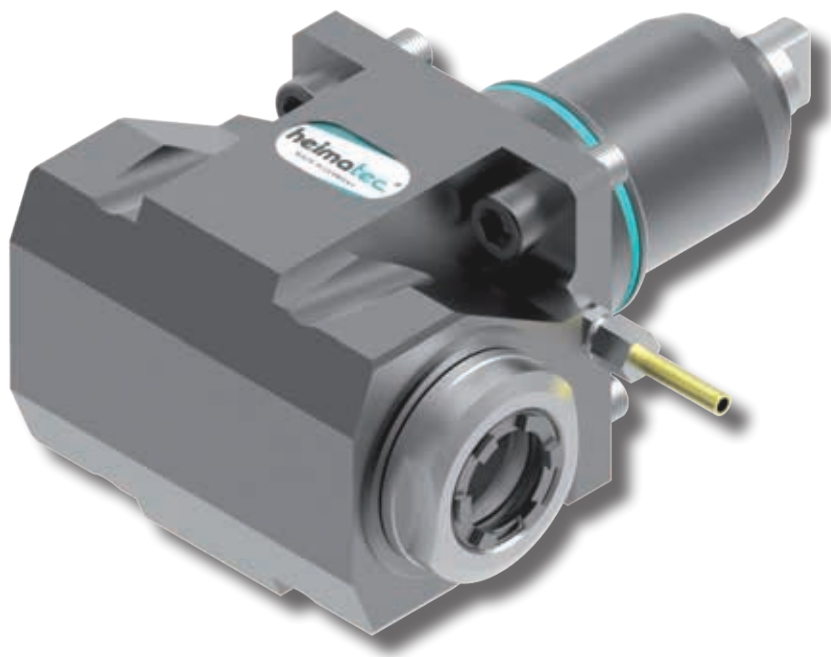

# Nakamura

12 Stationen / 12 stations

Super NTY 3 Jumbo

100er Revolver (65) / 100 turret (65)



Das Katalog-Werk einschließlich aller seiner Teile ist urheberrechtlich geschützt. Jede Verwertung außerhalb der engen Grenzen des Urheberrechtsgesetzes ist ohne Zustimmung der Rechteinhaber unzulässig und strafbar. Das gilt insbesondere für Vervielfältigungen, Übersetzungen, Mikroverfilmungen und die Einspeicherung und Verarbeitung in elektronischen Systemen.

**heimatec® GmbH** behält sich Änderungen technischer Art jederzeit ohne Vorankündigung vor. Dies gilt insbesondere bei Anpassungen an neue oder geänderte internationale Normen oder bei Weiterentwicklungen unserer Produkte oder Herstellungsprozesse.

This catalogue, including all its parts, is protected by copyright. Each use outside the restricted limitations of the Copyright Act is inadmissible and liable to prosecution without the consent of heimatec. This is particularly valid for duplication, translation, microfilming and feeding and processing in electronic systems.

**heimatec® GmbH** reserves the right of technical changes everytime without advance notice, which is particularly valid for adaptations to new or changed international standards, or to developments of our products or manufacturing processes.

Hinweis zu den AGBs:  
Diese finden Sie in unserem Internetauftritt unter  
**heimatec.de**  
Home/Impressum/AGB

Terms and conditions:  
You will find them on our website  
**heimatec.com**  
Home/Imprint/Terms and Conditions



## angetriebene Werkzeuge

driven tools



### Axial-Bohr- und Fräskopf

axial drilling and milling head

$n_{max} = 6000 \text{ min}^{-1}$

8 010 66 126	ER 32 A u-tec	EK	1:1
8 010 66 127	ER 32 A u-tec	IK 70 bar	1:1



### Axial-Bohr- und Fräskopf

axial drilling and milling head

$n_{max} = 5000 \text{ min}^{-1}$

8 010 66 050	ER 32 A u-tec	EK	1:1
8 010 66 066	ER 32 A u-tec	IK 25 bar	1:1
8 010 66 067	ER 32 A u-tec	IK 70 bar	1:1
8 010 67 013	easy quick HT 5	EK	1:1
8 010 67 016	easy quick HT 5	IK 25 bar	1:1
8 010 67 029	easy quick HT 5	IK 70 bar	1:1

$n_{max} = 6000 \text{ min}^{-1}$



### Axial-Bohr- und Fräskopf

axial drilling and milling head

$n_{max} = 24000 \text{ min}^{-1}$

8 013 64 002	ER 16 A u-tec	EK	1:4
8 013 64 004	ER 16 A u-tec	IK 70 bar	1:4



### Axial-Bohr- und Fräskopf

axial drilling and milling head

$n_{max} = 5000 \text{ min}^{-1}$

8 011 65 013	Kombidorn/universal arbor 22	EK	1:1
8 011 66 009	Kombidorn/universal arbor 27	EK	1:1
8 011 64 006	Kombidorn/universal arbor 3/4"	EK	1:1



### Axial-Bohr- und Fräskopf

axial drilling and milling head

Achsversatz / offset A=50

8 019 65 001	ER 25 A u-tec	EK	1:1
8 019 65 011	ER 25 A u-tec	IK 140 bar	1:1
$n_{max} = 6000 \text{ min}^{-1}$			
8 019 65 010	ER 25 A u-tec	EK	1:2
8 019 65 007	ER 25 A u-tec	IK 140 bar	1:2
$n_{max} = 12000 \text{ min}^{-1}$			
8 019 65 006	ER 25 A u-tec	EK	1:3
8 019 65 012	ER 25 A u-tec	IK 140 bar	1:3
$n_{max} = 15000 \text{ min}^{-1}$			



### Winkel-Bohr- und Fräskopf

radial drilling and milling head

Mittenmaß / center distance H=65

8 030 66 078	ER 32 A u-tec	EK	1:1
8 030 66 090	ER 32 A u-tec	IK 140 bar	1:1
$n_{max} = 6000 \text{ min}^{-1}$			
8 030 67 087	easy quick HT 5	EK	1:1
8 030 67 088	easy quick HT 5	IK 140 bar	1:1
$n_{max} = 6000 \text{ min}^{-1}$			
8 030 66 103	ER 32 A u-tec	EK	2:1
8 030 66 127	ER 32 A u-tec	IK 140 bar	2:1
$n_{max} = 3000 \text{ min}^{-1}$			
8 030 67 116	easy quick HT 5	EK	2:1
8 030 67 117	easy quick HT 5	IK 140 bar	2:1
$n_{max} = 3000 \text{ min}^{-1}$			



### Winkel-Bohr- und Fräskopf

radial drilling and milling head

Mittenmaß / center distance H=80

8 030 65 057	ER 25 A u-tec	EK	1:2
8 030 65 020	ER 25 A u-tec	IK 140 bar	1:2
$n_{max} = 12000 \text{ min}^{-1}$			
8 030 66 128	easy quick HT 4	EK	1:2
8 030 66 129	easy quick HT 4	IK 140 bar	1:2
$n_{max} = 12000 \text{ min}^{-1}$			
8 030 65 038	ER 25 A u-tec	EK	1:3
8 030 65 039	ER 25 A u-tec	IK 140 bar	1:3
$n_{max} = 18000 \text{ min}^{-1}$			
8 030 66 130	easy quick HT 4	EK	1:3
8 030 66 131	easy quick HT 4	IK 140 bar	1:3
$n_{max} = 18000 \text{ min}^{-1}$			

► Weitere Ausführungen auf Anfrage  
further versions on request

► Zubehör ZB...\* accessories ZB...\*

► easy-quick

► u-tec



### Winkel-Bohr- und Fräskopf radial drilling and milling head

Mittenmaß / center distance  $H=65$   
 $n_{max} = 24000 \text{ min}^{-1}$

8 030 64 015	ER 16 A u-tec	EK	1:4
8 030 64 018	ER 16 A u-tec	IK 140 bar	1:4



### Winkel-Bohr- und Fräskopf radial drilling and milling head

Mittenmaß / center distance  $H=65$   
 $n_{max} = 6000 \text{ min}^{-1}$

8 031 65 006	Kombidorn/universal arbor 22	EK 1:1	
8 031 66 011	Kombidorn/universal arbor 27	EK 1:1	
8 031 64 003	Kombidorn/universal arbor 3/4"	EK 1:1	
8 031 65 019	Kombidorn/universal arbor 1"	EK 1:1	

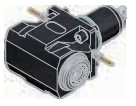

### Winkel-Bohr- und Fräskopf radial drilling and milling head

Mittenmaß / center distance  $H=65$   
 $n_{max} = 6000 \text{ min}^{-1}$   
doppelspindel / double spindle

8 039 65 014	2x ER 25 A u-tec	EK	1:1
8 039 66 028	2x ER 32 A u-tec	EK	1:1
8 039 67 001	2x easy quick HT 5	EK	1:1



### Schwenkkopf universal head

Mittenmaß / center distance  $H=64$   
 $n_{max} = 5000 \text{ min}^{-1}$

8 040 64 000	ER 16	EK	1:1
--------------	-------	----	-----



### Schwenkkopf universal head

Mittenmaß / center distance  $H=60$   
Achsversatz / offset  $A=35$

8 043 64 003	ER 16 A u-tec	EK	1:1
8 043 64 007	ER 16 A u-tec	IK 140 bar	1:1
$n_{max} = 6000 \text{ min}^{-1}$			
8 043 64 006	ER 16 A u-tec	EK	1:2
8 043 64 012	ER 16 A u-tec	IK 140 bar	1:2
$n_{max} = 12000 \text{ min}^{-1}$			



### Winkel-Scheibenfräserkopf radial disk mill head

$\pm 10^\circ$  drehbar  
 $\pm 10^\circ$  turnable

Mittenmaß / center distance  $H=87,5$   
auf  $0^\circ$  absteckbar /  $0^\circ$  can be pinned  
 $n_{max} = 3000 \text{ min}^{-1}$   
kein Kühlmittel / no coolant

8 037 65 002	$\varnothing 22$	2:1
8 037 66 000	$\varnothing 27$	2:1
8 037 64 007	$\varnothing 3/4"$	2:1
8 037 65 007	$\varnothing 1"$	2:1

► Weitere Ausführungen auf Anfrage  
further versions on request

► Zubehör ZB...\*  
accessories ZB...\*



► easy-quick



► u-tec



## festе Werkzeuge

static tool holders

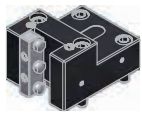

**Kombi-Drehstahlhalter**  
universal turning holder

- |              |                    |    |
|--------------|--------------------|----|
| 8 224 15 000 | Vierkant/square 25 | EK |
| 8 224 15 008 | Vierkant/square 1" | EK |



**Doppel-Drehstahlhalter**  
double turning holder

- |              |                    |    |
|--------------|--------------------|----|
| 8 251 15 000 | Vierkant/square 25 | EK |
| 8 251 15 007 | Vierkant/square 1" | EK |



**Abstechhalter / Drehhalter**  
cut-off holder / turning holder

- |              |                    |     |    |
|--------------|--------------------|-----|----|
| 8 224 12 011 | Vierkant/square 25 | (1) | EK |
| 8 224 12 021 | Vierkant/square 1" | (1) | EK |
| 8 225 12 003 | Vierkant/square 25 | (2) | EK |
| 8 225 12 006 | Vierkant/square 1" | (2) | EK |
| 8 224 12 010 | Vierkant/square 25 | (3) | EK |
| 8 224 12 022 | Vierkant/square 1" | (3) | EK |
| 8 225 12 002 | Vierkant/square 25 | (4) | EK |
| 8 225 12 007 | Vierkant/square 1" | (4) | EK |

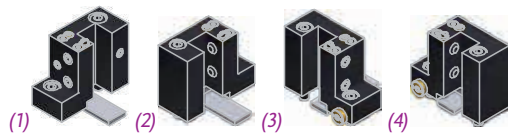

**Abstechhalter**  
cut-off holder

- |              |       |     |    |
|--------------|-------|-----|----|
| 8 224 13 008 | SH 32 | (1) | EK |
| 8 224 13 009 | SH 32 | (2) | EK |

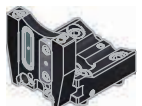

**Abstechhalter**  
cut-off holder

*höhenverstellbar / height adjustable*

- |              |       |     |           |
|--------------|-------|-----|-----------|
| 8 320 13 004 | SH 32 | (1) | IK 70 bar |
| 8 320 13 017 | SH 32 | (2) | IK 70 bar |
| 8 320 13 016 | SH 32 | (3) | IK 70 bar |



**Abstechhalter**  
cut-off holder

*höhenverstellbar / height adjustable*

- |              |                 |     |           |
|--------------|-----------------|-----|-----------|
| 8 320 19 002 | HORN System 845 | (1) | IK 70 bar |
| 8 320 19 017 | HORN System 845 | (2) | IK 70 bar |

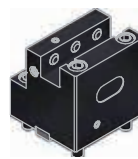

**Plandrehhalter**  
facing holder

- |              |                    |    |
|--------------|--------------------|----|
| 8 244 12 000 | Vierkant/square 25 | EK |
| 8 244 12 006 | Vierkant/square 1" | EK |

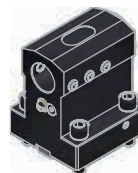

**Bohrstangenhalter**  
boring bar holder

*Mittenmaß / center distance H=90*

- |              |         |       |
|--------------|---------|-------|
| 8 240 18 000 | ø32     | IK/EK |
| 8 240 19 000 | ø40     | IK/EK |
| 8 240 18 041 | ø1 1/4" | IK/EK |
| 8 240 18 035 | ø1 1/2" | IK/EK |

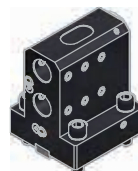

**Doppel-Bohrstangenhalter**  
double boring bar holder

*Mittenmaß / center distance H=57,5 / 100*

- |              |        |       |
|--------------|--------|-------|
| 8 253 17 007 | 2x ø25 | IK/EK |
| 8 253 17 050 | 2x ø1" | IK/EK |



**Halte für Wendepplattenbohrer**  
insert drill holder

*Mittenmaß / center distance H=85*

- |              |     |    |
|--------------|-----|----|
| 8 240 15 009 | ø16 | IK |
| 8 240 16 011 | ø20 | IK |
| 8 240 17 025 | ø25 | IK |
| 8 240 18 022 | ø32 | IK |
| 8 240 19 019 | ø40 | IK |

heimatec®

► Weitere Ausführungen auf Anfrage  
further versions on request

► Zubehör ZB...\*  
accessories ZB...\*

► easy-quick

► u-tec



**Spannzangenhalter  
collet chuck holder**

Mittenmaß / center distance H=90

8 240 16 031 ER 32 IK/EK  
8 240 17 060 ER 40 IK/EK

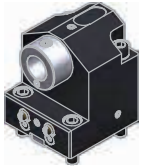

**Aufnahmehalter  
tool holder**

Mittenmaß / center distance H=90

8 240 17 018 easy quick HT 5 IK/EK



**Doppel-Spannzangenhalter  
double collet chuck holder**

Mittenmaß / center distance H=90

8 249 16 011 2x ER 32 IK/EK  
8 249 17 006 2x ER 40 IK/EK



**Doppel-Aufnahmehalter  
double tool holder**

Mittenmaß / center distance H=90

8 249 17 007 2x easy quick HT 5 IK/EK



**Stahlhalter mit rotierender Spitze  
tool holder with rotating centering point**

Mittenmaß / center distance H=90

8 263 19 010 EK



**Stahlhalter für Zentriereinsatz  
tool holder for centering insert**

Mittenmaß / center distance H=57,5

Preis ohne Zentriereinsatz / price without centering insert

8 261 18 002 ø32 EK





**Abdeckblech  
cover plate**

8 200 03 001

▶ Weitere Ausführungen auf Anfrage  
further versions on request

▶ Zubehör ZB...\*   
accessories ZB...\*

▶ easy-quick 

▶ u-tec 

► **easy-quick HT Schnellwechselsystem**  
**easy-quick HT fast change system**

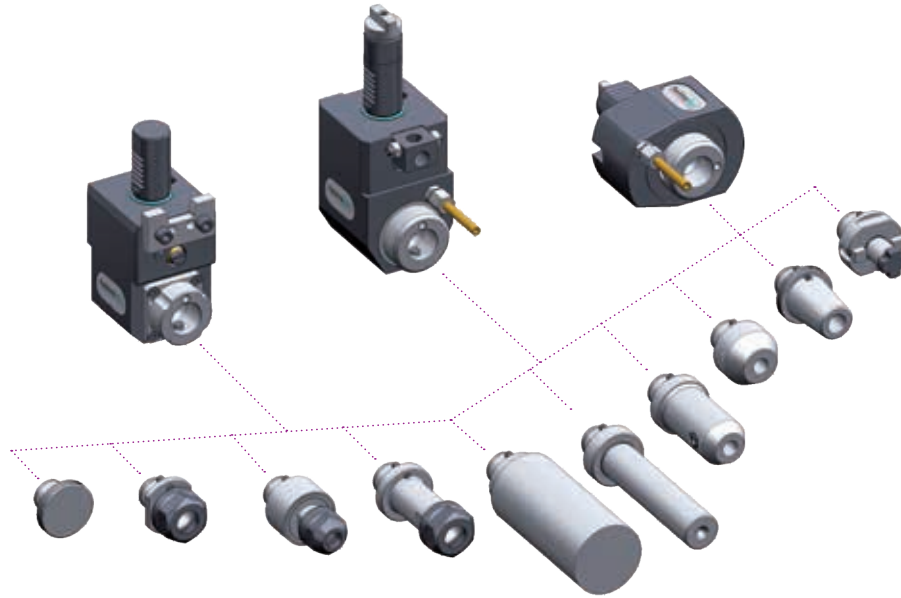

► Ausführungen siehe Katalog  
versions see catalogue



[heimatec.de](http://heimatec.de)  
Produkte / easy-quick

[heimatec.com](http://heimatec.com)  
products / easy-quick

► **u-tec® UT Wechselsystem**  
**u-tec® UT change system**

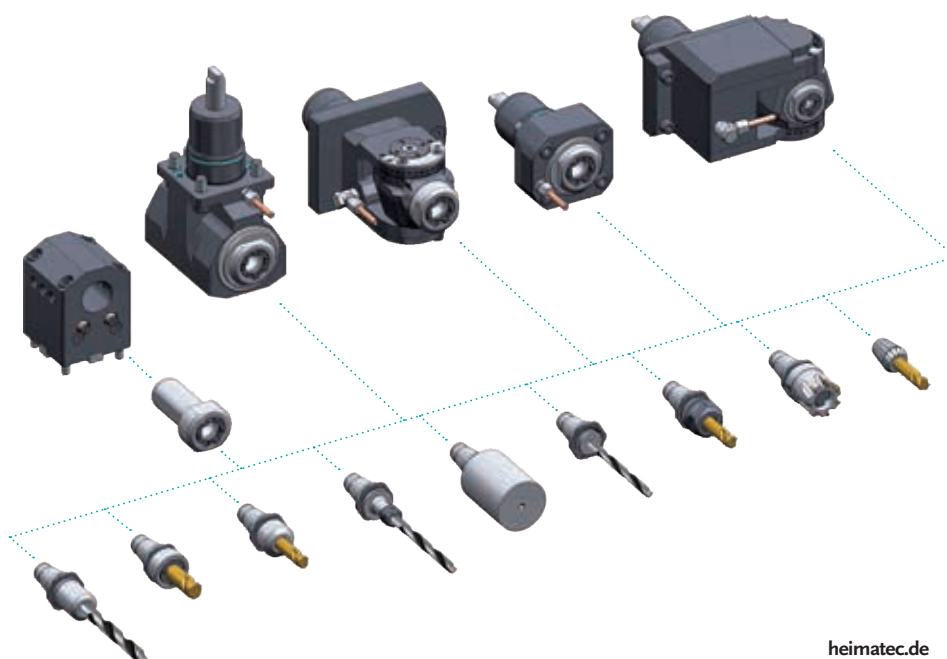

► Ausführungen siehe Katalog  
versions see catalogue



[heimatec.de](http://heimatec.de)  
Produkte / u-tec

[heimatec.com](http://heimatec.com)  
products / u-tec



# heimatec®

- heimatec®-Niederlassungen  
*heimatec® overseas branches*
- unsere weltweiten Vertretungen  
*global representations of heimatec®*



## Hauptsitz/headquarters

heimatec® GmbH  
Präzisionswerkzeuge  
Carl-Benz-Straße 4  
D- 77871 Renchen  
Postfach 11 36  
D- 77867 Renchen  
Tel.: +49 (78 43) 94 66 0  
Fax: +49 (78 43) 94 66 66  
heimatec.de  
info@heimatec.de

heimatec® Inc.  
USA  
usa.heimatec.com  
USA@heimatec.com  
  
heimatec®-Ost, JSC  
Russia  
ru.heimatec.com  
Russia@heimatec.com

heimatec® Ltd.  
Taiwan  
tw.heimatec.com  
Taiwan@heimatec.com  
  
heimatec®  
Singapore  
sg.heimatec.com  
Singapore@heimatec.com

heimatec® India Pvt Ltd.  
India  
in.heimatec.com  
India@heimatec.com  
  
heimatec®  
China  
cn.heimatec.com  
China@heimatec.com