

Miyano

**BNE 51 S oberer
Revolver -
Kegelrad**



High-tech from heimatec - heimatec - Tools and systems for productive turning and milling

heimatec belongs to the international technology and quality leaders for precision tools and specializes in the development and production of high-precision static and live tools for all CNC lathes, CNC turn-/mill machines and CNC machining centers.

The range of products* spans from static BMT and VDI tool holders, live tools up to highly complex customer-specific individual solutions. heimatec, headquartered in Renchen, has a own subsidiary in Asia and India and numerous representatives as well as trading partners all over the world.

*OUR PRODCUTS

Static tool holders

Live tool units

Precision tools

Tools for turning and machining centres

Tools for swiss type lathes

Tool changing and uick-change systems

Tool systems for gear production

Digital tool management

This catalogue, including all its parts, is protected by copyright. Any use outside the restricted limitations of the Copyright Act without the consent of heimatec is inadmissible and liable to prosecution. This applies in particular to duplication, translation, microfilming and storage and processing in electronic systems.

heimatec GmbH reserves the right to make technical changes at any time without giving prior notice. This applies in particular to adjustments at any time to meet new or changed international standards, or in case of further developments of our products or manufacturing processes.

The current version of our General Terms and Conditions can be found on our website.

BNE 51 S oberer Revolver - Kegelrad

Part-#	Name	
8 010 44 019	Axial drilling and milling head ER 20 M	
	Weight [kg]:	2.190
	Tool drive:	Bevel gear
	Shank size [mm]:	45.00
	Shank type:	BMT
	Tool adaption:	ER 20 M
	Gear ratio [i]:	1:1
	Torque max [Nm]:	25
	Rotation max [1/min]:	6000
	Rotating direction:	same
	Coolant:	EXT
8 010 45 035	Axial drilling and milling head ER 25 M IC	
	Weight [kg]:	2.560
	Tool drive:	Bevel gear
	Shank size [mm]:	45.00
	Shank type:	BMT
	Tool adaption:	ER 25 M
	Gear ratio [i]:	1:1
	Torque max [Nm]:	25
	Rotation max [1/min]:	6000
	Rotating direction:	same
	Coolant:	IC/Ext
	Pressure max [bar]:	25
8 010 45 038	Axial drilling and milling head ER 25 M	
	Weight [kg]:	2.200
	Tool drive:	Bevel gear
	Shank size [mm]:	45.00
	Shank type:	BMT
	Tool adaption:	ER 25 M
	Gear ratio [i]:	1:1
	Torque max [Nm]:	25
	Rotation max [1/min]:	6000
	Rotating direction:	same
	Coolant:	EXT
8 010 45 058	Axial drilling and milling head ER 25 M IC	
	Weight [kg]:	2.580
	Tool drive:	Bevel gear
	Shank size [mm]:	45.00
	Shank type:	BMT
	Tool adaption:	ER 25 M
	Gear ratio [i]:	1:1
	Torque max [Nm]:	25
	Rotation max [1/min]:	6000
	Rotating direction:	same
	Coolant:	IC/Ext
	Pressure max [bar]:	25
	Please note:	stronger bearing

Part-#	Name	
8 011 44 005	Axial milling head universal arbor 16	
	Weight [kg]:	2.480
	Tool drive:	Bevel gear
	Shank size [mm]:	45.00
	Shank type:	BMT
	Tool adaption:	Universal arbor 16
	Gear ratio [i]:	1:1
	Torque max [Nm]:	25
	Rotation max [1/min]:	6000
	Rotating direction:	same
	Coolant:	EXT
	Please note:	stronger bearing
8 011 45 013	Axial milling head universal arbor 22	
	Weight [kg]:	2.580
	Tool drive:	Bevel gear
	Shank size [mm]:	45.00
	Shank type:	BMT
	Tool adaption:	Universal arbor 22
	Gear ratio [i]:	1:1
	Torque max [Nm]:	25
	Rotation max [1/min]:	6000
	Rotating direction:	same
	Coolant:	EXT
	Please note:	stronger bearing
8 030 44 012	Radial drilling and milling head ER 20 IC	
	Notation:	180° reversible
	Tool drive:	Bevel gear
	Shank size [mm]:	45.00
	Shank type:	BMT
	Tool adaption:	ER 20
	Gear ratio [i]:	1:1
	Torque max [Nm]:	25
	Rotation max [1/min]:	6000
	Rotating direction:	opposite
	Coolant:	IC/Ext
	Pressure max [bar]:	140
	Center distance [mm]:	55
8 030 44 019	Radial drilling and milling head ER 16	
	Weight [kg]:	4.660
	Notation:	180° reversible
	Tool drive:	Bevel gear
	Shank size [mm]:	45.00
	Shank type:	BMT
	Tool adaption:	ER 16
	Gear ratio [i]:	1:2
	Torque max [Nm]:	12
	Rotation max [1/min]:	12000
	Rotating direction:	opposite
	Coolant:	EXT
	Center distance [mm]:	55

BNE 51 S oberer Revolver - Kegelrad



Part-#	Name	
8 030 44 022	Radial drilling and milling head ER 20 AX	
	Weight [kg]:	4.700
	Notation:	180° reversible
	Tool drive:	Bevel gear
	Shank size [mm]:	45.00
	Shank type:	BMT
	Tool adaption:	ER 20 A
	Gear ratio [i]:	1:2
	Torque max [Nm]:	12
	Rotation max [1/min]:	12000
	Rotating direction:	opposite
	Coolant:	EXT
	Center distance [mm]:	55
8 030 45 060	Radial drilling and milling head ER 25 IC	
	Weight [kg]:	4.100
	Notation:	180° reversible
	Tool drive:	Bevel gear
	Shank size [mm]:	45.00
	Shank type:	BMT
	Tool adaption:	ER 25
	Gear ratio [i]:	1:1
	Torque max [Nm]:	25
	Rotation max [1/min]:	6000
	Rotating direction:	opposite
	Coolant:	IC/Ext
	Pressure max [bar]:	140
	Center distance [mm]:	55
8 030 45 178	Radial drilling and milling head ER 25 AX UT	
	Weight [kg]:	5.350
	Notation:	180° reversible
	Tool drive:	Bevel gear
	Shank size [mm]:	45.00
	Shank type:	BMT
	Tool adaption:	ER 25 A - u-tec
	Gear ratio [i]:	1:1
	Torque max [Nm]:	50
	Rotation max [1/min]:	6000
	Rotating direction:	opposite
	Coolant:	EXT
	Please note:	Check applicability!
	Center distance [mm]:	65
8 031 45 017	Radial milling head universal arbor 22	
	Weight [kg]:	3.780
	Notation:	180° reversible
	Tool drive:	Bevel gear
	Shank size [mm]:	45.00
	Shank type:	BMT
	Tool adaption:	Universal arbor 22
	Gear ratio [i]:	1:1
	Torque max [Nm]:	25
	Rotation max [1/min]:	6000
	Rotating direction:	opposite
	Coolant:	EXT
	Center distance [mm]:	55

BNE 51 S oberer Revolver - Kegelrad

Part-#	Name	
8 040 44 014	Universal head ± 90° adjustable ER 16	
	Weight [kg]:	3.140
	Tool drive:	Bevel gear
	Shank size [mm]:	45.00
	Shank type:	BMT
	Tool adaption:	ER 16
	Gear ratio [i]:	1:1
	Torque max [Nm]:	10
	Rotation max [1/min]:	6000
	Rotating direction:	same
	Coolant:	EXT
	Center distance [mm]:	55
8 043 44 013	Universal head +105°/-20° adj. ER16 AX UT	
	Weight [kg]:	5.860
	Notation:	offset
	Tool drive:	Bevel gear
	Shank size [mm]:	45.00
	Shank type:	BMT
	Tool adaption:	ER 16 A - u-tec
	Gear ratio [i]:	1:1
	Torque max [Nm]:	25
	Rotation max [1/min]:	6000
	Rotating direction:	opposite
	Coolant:	EXT
	Please note:	180° reversible
	Center distance [mm]:	50
	Offset [mm]:	35
8 043 45 003	Universal head +105°/-20° adj. Weldon 16	
	Weight [kg]:	6.090
	Notation:	offset; 180° reversible
	Version:	Special
	Tool drive:	Bevel gear
	Shank size [mm]:	45.00
	Shank type:	BMT
	Tool adaption:	Weldon (DIN 1835 b) 16 special
	Gear ratio [i]:	1:1
	Torque max [Nm]:	25
	Rotation max [1/min]:	6000
	Rotating direction:	opposite
	Coolant:	EXT
	Please note:	stronger bearing
	Center distance [mm]:	50
	Offset [mm]:	35
8 202 00 010	Basic holder longitudinal seat FN 12	
	Weight [kg]:	0.920
	Notation:	180° reversible
	Shank type:	BMT
	Machine adaption:	Centering bolt ø 12
	Tool adaption:	Interface FN 12
	Coolant:	EXT





BNE 51 S oberer Revolver - Kegellrad

Part-#	Name	
8 224 03 016	Universal turning holder sq. 3/4" IC	
	Weight [kg]:	2.630
	Notation:	180° reversible
	Shank type:	BMT
	Machine adaption:	Centering bolt \varnothing 12
	Tool adaption:	Sq. 3/4" (19,05mm)
		Sq. 3/4" (19,05mm)
	Coolant:	IC/Ext
	Pressure max [bar]:	100
	Please note:	Key rail
8 224 04 000	Universal turning holder sq. 20	
	Weight [kg]:	2.640
	Notation:	180° reversible
	Shank type:	BMT
	Machine adaption:	Centering bolt \varnothing 12
	Tool adaption:	Sq. 20
		Sq. 20
	Coolant:	EXT
8 224 04 035	Universal turning holder sq. 20 IC	
	Weight [kg]:	2.620
	Notation:	180° reversible
	Shank type:	BMT
	Machine adaption:	Centering bolt \varnothing 12
	Tool adaption:	Sq. 20
	Coolant:	IC
8 224 04 068	Universal turning holder sq. 20 IC	
	Weight [kg]:	2.610
	Notation:	180° reversible
	Shank type:	BMT
	Machine adaption:	Centering bolt \varnothing 12
	Tool adaption:	Sq. 20
		Sq. 20
	Coolant:	IC/Ext
	Pressure max [bar]:	100
	Please note:	Key rail
8 229 05 004	Tool holder C 3 IC	
	Weight [kg]:	2.980
	Notation:	180° reversible
	Version:	right
	Shank type:	BMT
	Machine adaption:	Centering bolt \varnothing 12
	Tool adaption:	heimatec Capto(TM) C 3
	Coolant:	IC
	Please note:	Check applicability; note tool length!
	Offset [mm]:	65

BNE 51 S oberer Revolver - Kegelrad

Part-#	Name	
8 229 05 005	Tool holder C 3 IC	
	Weight [kg]:	1.590
	Notation:	180° reversible
	Version:	right
	Shank type:	BMT
	Machine adaption:	Centering bolt ø 12
	Tool adaption:	heimatec Capto(TM) C 3
	Coolant:	IC
	Please note:	Check applicability; note tool length!
	Offset [mm]:	27
8 240 05 034	Boring bar holder Ø 16	
	Weight [kg]:	4.360
	Notation:	180° reversible
	Shank type:	BMT
	Machine adaption:	Centering bolt ø 12
	Tool adaption:	Ø 16
	Coolant:	IC/Ext
	Center distance [mm]:	75
8 240 05 059	Tool holder C 3 IC	
	Weight [kg]:	4.130
	Notation:	180° reversible
	Version:	right
	Shank type:	BMT
	Machine adaption:	Centering bolt ø 12
	Tool adaption:	heimatec Capto(TM) C 3
	Coolant:	IC
	Please note:	Check applicability; note tool length!
	Center distance [mm]:	80
8 240 05 060	Tool holder C 3 IC	
	Weight [kg]:	3.190
	Notation:	180° reversible
	Version:	offset; right
	Shank type:	BMT
	Machine adaption:	Centering bolt ø 12
	Tool adaption:	heimatec Capto(TM) C 3
	Coolant:	IC
	Please note:	Check applicability; note tool length!
	Center distance [mm]:	80
8 240 06 034	Boring bar holder Ø 20	
	Weight [kg]:	4.280
	Notation:	180° reversible
	Shank type:	BMT
	Machine adaption:	Centering bolt ø 12
	Tool adaption:	Ø 20
	Coolant:	IC/Ext
	Center distance [mm]:	75
8 240 07 038	Boring bar holder Ø 25	
	Weight [kg]:	4.160
	Notation:	180° reversible
	Shank type:	BMT
	Machine adaption:	Centering bolt ø 12
	Tool adaption:	Ø 25
	Coolant:	IC/Ext

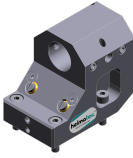
BNE 51 S oberer Revolver - Kegelrad

Part-#	Name	
	Center distance [mm]:	75
8 240 07 050	Boring bar holder Ø 1 1/4 "	
	Weight [kg]:	3.790
	Notation:	offset
	Shank type:	BMT
	Machine adaption:	Centering bolt ø 12
	Tool adaption:	Ø 1 1/4" (31,75mm)
	Coolant:	IC/Ext
	Center distance [mm]:	75
8 240 08 000	Boring bar holder Ø 32	
	Weight [kg]:	3.740
	Notation:	offset
	Shank type:	BMT
	Machine adaption:	Centering bolt ø 12
	Tool adaption:	Ø 32
	Coolant:	IC/Ext
	Center distance [mm]:	75
8 240 08 046	Boring bar holder Ø 32	
	Weight [kg]:	3.940
	Notation:	180° reversible
	Shank type:	BMT
	Machine adaption:	Centering bolt ø 12
	Tool adaption:	Ø 32
	Coolant:	IC/Ext
	Center distance [mm]:	75
8 240 08 074	Boring bar holder Ø 1 1/2"	
	Weight [kg]:	4.000
	Shank type:	BMT
	Machine adaption:	Centering bolt ø 12
	Tool adaption:	Ø 1 1/2" (38,1mm)
	Coolant:	IC/Ext
	Center distance [mm]:	75
8 240 09 002	Boring bar holder Ø 40	
	Weight [kg]:	2.660
	Version:	offset
	Shank type:	BMT
	Machine adaption:	Centering bolt Ø 12
	Tool adaption:	Ø 40
	Coolant:	IC/Ext
	Center distance [mm]:	75
8 240 09 013	Boring bar holder Ø 40	
	Weight [kg]:	3.950
	Shank type:	BMT
	Machine adaption:	Centering bolt Ø 12
	Tool adaption:	Ø 40
	Coolant:	IC/Ext
	Center distance [mm]:	75

BNE 51 S oberer Revolver - Kegelrad



Part-#	Name	
8 244 04 019	Combi facing holder sq. 20	
	Weight [kg]:	3.700
	Shank type:	BMT
	Machine adaption:	Centering bolt ø 12
	Tool adaption:	Sq. 20
	Coolant:	EXT
8 249 05 008	Double tool holder C 3 IC	
	Weight [kg]:	4.860
	Employment for:	Main- and sub spindle
	Version:	right
	Shank type:	BMT
	Machine adaption:	Centering bolt ø 12
	Tool adaption:	heimatec Capto(TM) C 3 heimatec Capto(TM) C 3
	Coolant:	IC
	Please note:	Check applicability; note tool length!
	Center distance [mm]:	80
8 250 05 002	Multiple tool holder C 3 IC	
	Weight [kg]:	2.140
	Employment for:	Main- and sub spindle
	Version:	right
	Shank type:	BMT
	Machine adaption:	Centering bolt ø 12
	Tool adaption:	heimatec Capto(TM) C 3 heimatec Capto(TM) C 3
	Coolant:	IC
	Please note:	Check applicability; note tool length!
	Offset [mm]:	27 27
8 250 05 003	Multiple tool holder C 3 IC	
	Weight [kg]:	3.730
	Employment for:	Main- and sub spindle
	Version:	right
	Shank type:	BMT
	Machine adaption:	Centering bolt ø 12
	Tool adaption:	heimatec Capto(TM) C 3 heimatec Capto(TM) C 3
	Coolant:	IC
	Please note:	Check applicability; note tool length!
	Offset [mm]:	65 65
8 251 03 002	Combi double turning holder sq. 3/4"IC	
	Weight [kg]:	4.360
	Notation:	180° reversible
	Shank type:	BMT
	Machine adaption:	Centering bolt ø 12
	Tool adaption:	Sq. 3/4" (19,05mm) Sq. 3/4" (19,05mm) Sq. 3/4" (19,05mm) Sq. 3/4" (19,05mm)
	Coolant:	IC/Ext
	Pressure max [bar]:	100
	Please note:	Key rail



BNE 51 S oberer Revolver - Kegelrad

Part-#	Name	
8 251 04 002	Combi double turning holder sq. 20	
	Weight [kg]:	4.380
	Notation:	180° reversible
	Shank type:	BMT
	Machine adaption:	Centering bolt ø 12
	Tool adaption:	Sq. 20
		Sq. 20
		Sq. 20
		Sq. 20
	Coolant:	EXT
8 251 04 003	Combi double turning holder sq. 3/4"	
	Weight [kg]:	4.410
	Notation:	180° reversible
	Shank type:	BMT
	Machine adaption:	Centering bolt ø 12
	Tool adaption:	Sq. 3/4" (19,05mm)
		Sq. 3/4" (19,05mm)
		Sq. 3/4" (19,05mm)
		Sq. 3/4" (19,05mm)
	Coolant:	EXT
8 251 04 059	Combi double turning holder sq. 20 IC	
	Weight [kg]:	4.360
	Notation:	180° reversible
	Shank type:	BMT
	Machine adaption:	Centering bolt ø 12
	Tool adaption:	Sq. 20
		Sq. 20
		Sq. 20
		Sq. 20
	Coolant:	IC/Ext
	Pressure max [bar]:	100
	Please note:	Key rail
8 253 07 000	Double boring bar holder Ø 25	
	Weight [kg]:	2.320
	Notation:	offset, 180° reversible
	Shank type:	BMT
	Machine adaption:	Centering bolt ø 12
	Tool adaption:	Ø 25
		Ø 25
	Coolant:	IC/Ext
	Center distance [mm]:	50/85
8 253 07 003	Multiple boring bar holder Ø 1"	
	Weight [kg]:	2.530
	Notation:	offset, 180° reversible
	Shank type:	BMT
	Machine adaption:	Centering bolt ø 12
	Tool adaption:	Ø 1" (25,4mm)
		Ø 1" (25,4mm)
	Coolant:	IC/Ext
	Center distance [mm]:	50/85

BNE 51 S oberer Revolver - Kegelrad

Part-#	Name	
8 253 07 004	Double boring bar holder Ø 1"	
	Weight [kg]:	3.740
	Notation:	180° reversible
	Shank type:	BMT
	Machine adaption:	Centering bolt Ø 12
	Tool adaption:	Ø 1" (25,4mm)
		Ø 1" (25,4mm)
	Coolant:	IC/Ext
	Center distance [mm]:	50/85
8 253 07 006	Double boring bar holder Ø 25	
	Weight [kg]:	3.710
	Notation:	180° reversible
	Shank type:	BMT
	Machine adaption:	Centering bolt Ø 12
	Tool adaption:	Ø 25
		Ø 25
	Coolant:	IC/Ext
	Center distance [mm]:	50/85
8 259 01 006	Multiple turning holder 4x sq. 20	
	Weight [kg]:	4.700
	Employment for:	Main- and sub spindle
	Version:	Y-axes offset
	Shank type:	BMT
	Machine adaption:	Centering bolt Ø 12
	Tool adaption:	Sq. 20
		Sq. 20
		Sq. 20
		Sq. 20
	Coolant:	EXT
8 259 09 001	Multiple holder Ø25 and sq. 20	
	Weight [kg]:	3.980
	Notation:	180° reversible
	Shank type:	BMT
	Machine adaption:	Centering bolt Ø 12
	Tool adaption:	Ø25/ sq. 20
		Ø25/ sq. 20
	Coolant:	IC/Ext
	Center distance [mm]:	50/85
8 261 08 000	Tool holder for centering insert	
	Weight [kg]:	5.270
	Notation:	180° reversible
	Shank type:	BMT
	Machine adaption:	Centering bolt Ø 12
	Tool adaption:	Ø 32
	Coolant:	EXT
	Please note:	Price without centering point
	Center distance [mm]:	55

BNE 51 S oberer Revolver - Kegelrad

Part-#	Name	
8 263 09 000	Tool holder with rotating centering point	
	Weight [kg]:	4.070
	Notation:	180° reversible
	Shank type:	BMT
	Machine adaption:	Centering bolt ø 12
	Rotation max [1/min]:	6000
	Coolant:	EXT
	Please note:	Taper roller bearings
	Center distance [mm]:	75
8 263 09 007	Tool holder with rotating centering point	
	Weight [kg]:	6.410
	Notation:	180° reversible; offset
	Shank type:	BMT
	Machine adaption:	Centering bolt ø 12
	Rotation max [1/min]:	6000
	Coolant:	EXT
	Center distance [mm]:	85
8 320 02 017	Cut-off holder, height adjustable SH 26 IC	
	Notation:	180° reversible
	Shank type:	BMT
	Machine adaption:	Centering bolt ø 12
	Tool adaption:	Clampshaft SH 26
	Coolant:	IC/Ext
	Pressure max [bar]:	70
8 320 02 018	Cut-off holder, height adjustable SH 26 IC	
	Notation:	180° reversible
	Shank type:	BMT
	Machine adaption:	Centering bolt ø 12
	Tool adaption:	Clampshaft SH 26
	Coolant:	IC/Ext
	Pressure max [bar]:	70
	Please note:	Clampshaft internal
8 320 09 003	Cut-off holder, height adjustable 845 IC	
	Weight [kg]:	1.390
	Notation:	180° reversible
	Shank type:	BMT
	Machine adaption:	Centering bolt ø 12
	Tool adaption:	 System 845
	Coolant:	IC
	Pressure max [bar]:	70

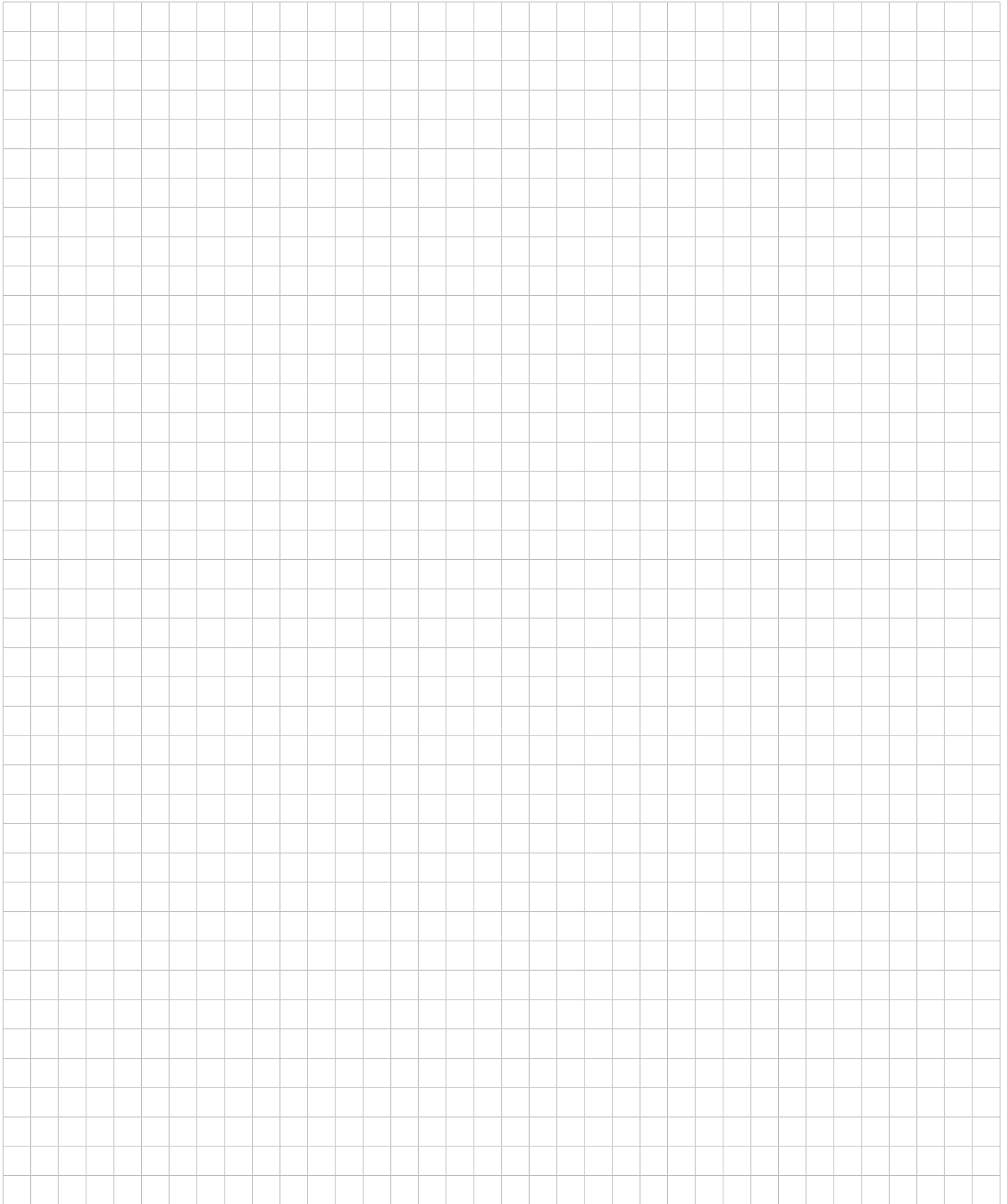

heimatec.u-tec®

heimatec.com

Products / Tool change systems /
u-tec® Tool-changing system



versions see catalog

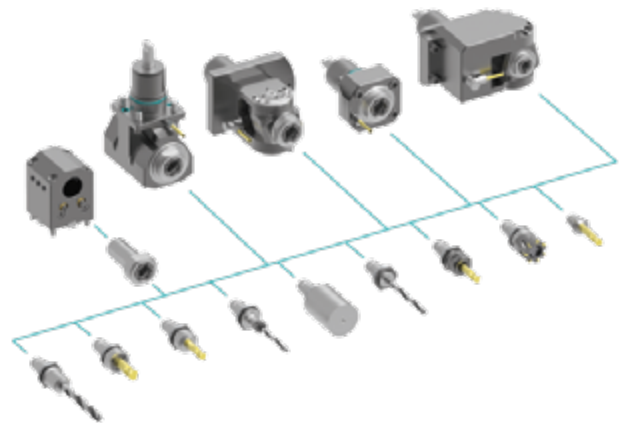

heimatec.easy-quick

heimatec.com

Products / Tool change systems /
easy-quick HT quick-changing system



versions see catalog

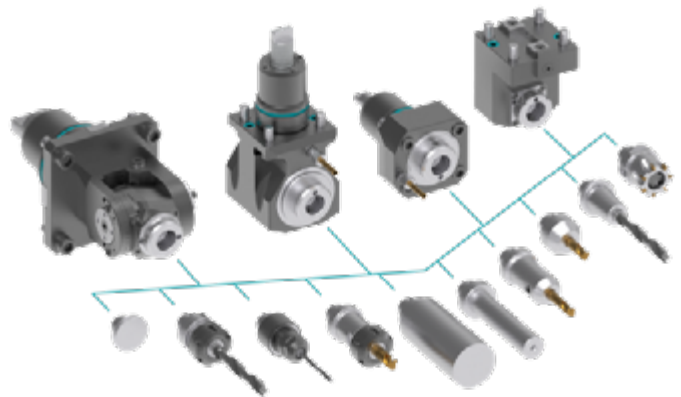

heimatec.Capto™

heimatec.com

Products / Tool change systems /
heimatec.Capto™ quick-changing system



versions see catalog

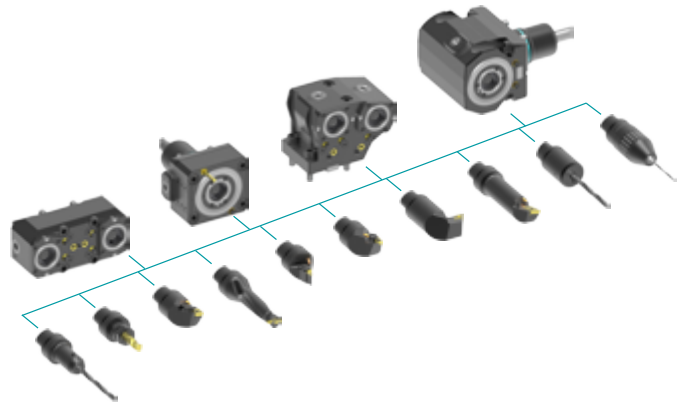

heimatec.accessories

heimatec.com

Products / Accessories



versions see catalog





● heimatec overseas branches

○ global representations of heimatec

heimatec[®]

heimatec GmbH
Präzisionswerkzeuge
Carl-Benz-Str. 4
77871 Renchen
Germany

T +49 7843 9466 0
www.heimatec.com
info@heimatec.com

Please find the contact details of our worldwide trading partners on our website:
<https://heimatec.com/business-partners>